

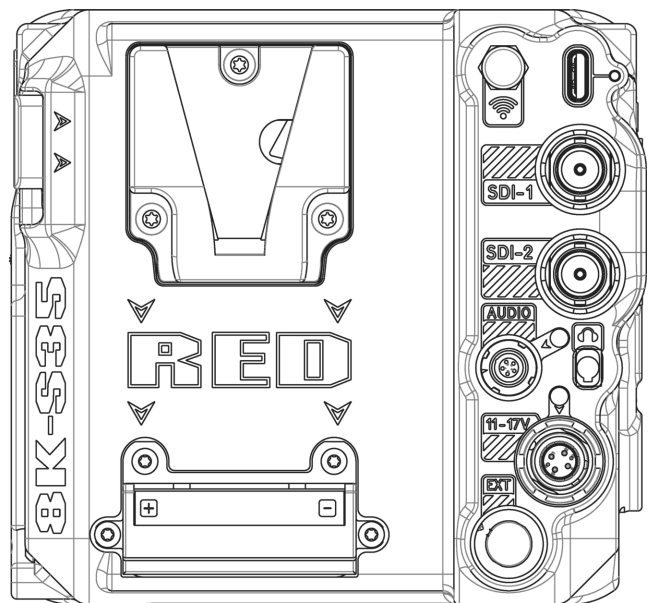

# V-RAPTOR™ 8K S35

## OPERATION GUIDE

---

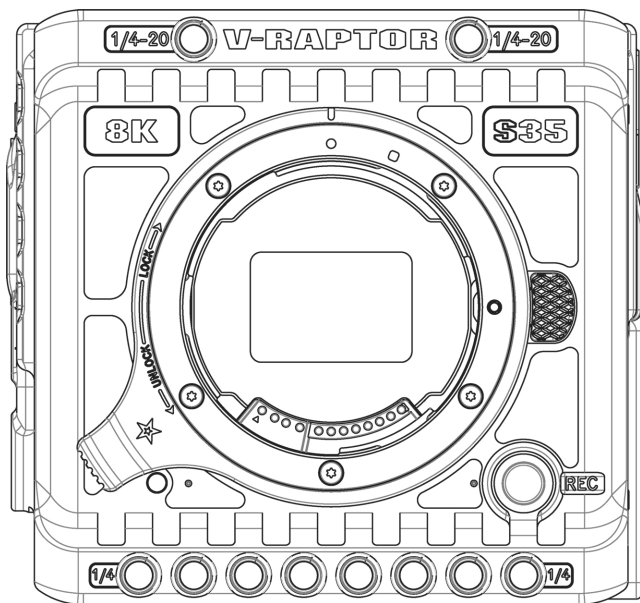

---

V-RAPTOR 8K S35 | V1.4, REV. B

RED.COM

# TABLE OF CONTENTS

|   |           |                                    |     |
|---|-----------|------------------------------------|-----|
| <b>DISCLAIMER</b> .....                 | <b>V</b>  | PRORES PROXY RECORD .....          | 73  |
| <b>SAFETY INSTRUCTIONS</b> .....        | <b>VI</b> | PRORES RESOLUTION .....            | 74  |
| <b>1. INTRODUCTION</b>                  |           | PRORES CODEC .....                 | 74  |
| V-RAPTOR™ 8K S35 .....                  | 1         | PRORES COLOR PROFILE .....         | 75  |
| <b>2. QUICK REFERENCE</b>               |           | PRE-RECORD .....                   | 75  |
| PREPARING THE CAMERA HARDWARE .....     | 4         | RECORDING MODE .....               | 77  |
| PREPARING THE CAMERA SYSTEM .....       | 4         | TIMELAPSE .....                    | 77  |
| RECORDING .....                         | 4         | FRAME LIMIT .....                  | 78  |
| PROCESSING FOOTAGE .....                | 4         | SLATE .....                        | 79  |
| <b>3. CAMERA COMPONENTS</b>             |           | <b>AUDIO / TC MENU</b> .....       | 82  |
| CAMERA BODY .....                       | 5         | AUDIO SOURCE .....                 | 84  |
| CAMERA BODY CONTROLS AND FEATURES ..... | 5         | INTERNAL MICROPHONE (CH 1/2) ..... | 84  |
| FRONT .....                             | 5         | EXTERNAL (CH 3/4) .....            | 85  |
| BACK .....                              | 6         | HEADPHONE .....                    | 86  |
| LEFT .....                              | 7         | TIMECODE SOURCE .....              | 87  |
| RIGHT .....                             | 8         | TIMECODE DISPLAY MODE .....        | 89  |
| TOP .....                               | 9         | <b>MONITORING MENU</b> .....       | 89  |
| BOTTOM .....                            | 10        | TOP LCD .....                      | 90  |
| CAMERA BODY LEDS .....                  | 11        | SDI 1 / 2 .....                    | 92  |
| LENSES AND ADAPTERS .....               | 15        | LIVE STREAM .....                  | 103 |
| LCD .....                               | 17        | TOOLS .....                        | 104 |
| LCD NAVIGATION .....                    | 17        | GUIDES .....                       | 110 |
| MENUS .....                             | 18        | <b>MEDIA MENU</b> .....            | 117 |
| PAGES .....                             | 19        | EJECT .....                        | 117 |
| HOME PAGE .....                         | 22        | MEDIA INFO .....                   | 118 |
| HISTOGRAM PAGE .....                    | 28        | SECURE FORMAT .....                | 118 |
| TOOLS PAGE .....                        | 31        | <b>USER SETTINGS MENU</b> .....    | 121 |
| SDI PAGE .....                          | 34        | PRESETS .....                      | 121 |
| AUDIO CHANNELS 1 / 2 PAGE .....         | 35        | SIDE LCD CONTROL PANELS .....      | 124 |
| AUDIO CHANNELS 3 / 4 PAGE .....         | 37        | USER 1, 2, 3 .....                 | 124 |
| HEADPHONE PAGE .....                    | 39        | USER BUTTONS .....                 | 126 |
| SENSOR SYNC SHIFT PAGE .....            | 40        | <b>AUTOFOCUS MENU</b> .....        | 128 |
| USER PAGES .....                        | 40        | ENABLE .....                       | 128 |
| STATUS BAR .....                        | 41        | MODE .....                         | 129 |
| RED CONTROL APP .....                   | 45        | SIZE .....                         | 129 |
| RED CONTROL PRO .....                   | 46        | POSITION .....                     | 130 |
| <b>4. MENUS</b>                         |           | <b>COMMUNICATION MENU</b> .....    | 131 |
| IMAGE / LUT MENU .....                  | 48        | CAMERA .....                       | 131 |
| ISO .....                               | 49        | CONNECTIONS .....                  | 132 |
| SHUTTER .....                           | 49        | CLIENTS & SERVICES .....           | 144 |
| WHITE BALANCE .....                     | 51        | CLOUD UPLOAD .....                 | 146 |
| OUTPUT COLOR SPACE .....                | 54        | <b>SYSTEM SETTINGS MENU</b> .....  | 150 |
| OUTPUT TONE MAP .....                   | 54        | DATE / TIME .....                  | 151 |
| HIGHLIGHT ROLL-OFF .....                | 55        | LENS .....                         | 152 |
| DISPLAY PRESET .....                    | 55        | POWER .....                        | 153 |
| 3D LUT .....                            | 56        | SENSOR .....                       | 154 |
| CDL .....                               | 57        | INDICATORS .....                   | 155 |
| EXPOSURE ADJUST .....                   | 61        | GPO FUNCTION .....                 | 156 |
| PROJECT SETTINGS MENU .....             | 62        | STATUS SETTINGS .....              | 156 |
| FORMAT .....                            | 63        | SYSTEM STATUS .....                | 158 |
| RECORDING FRAME RATE .....              | 69        | <b>LANGUAGE MENU</b> .....         | 159 |
| PROJECT TIME BASE .....                 | 70        | <b>MAINTENANCE MENU</b> .....      | 160 |
| FILE FORMAT .....                       | 70        | CALIBRATE .....                    | 160 |
| R3D QUALITY .....                       | 73        | CALIBRATION .....                  | 161 |
|   |           | SAVE LOG .....                     | 161 |
|   |           | RESET DEFAULTS .....               | 162 |
|   |           | FACTORY RESET .....                | 162 |
|   |           | UPGRADE .....                      | 162 |

## 5. HOW-TO

|   |     |
|---|-----|
| WI-FI CONFIGURATION .....                                   | 163 |
| CONNECTING WIRELESSLY TO AN EXISTING<br>WI-FI NETWORK ..... | 163 |
| FTPS CONFIGURATION .....                                    | 166 |
| CAMERA SET-UP .....   | 166 |
| SOFTWARE SET-UP (FILEZILLA) .....                           | 167 |
| ADDITIONAL INFORMATION .....                                | 168 |
| USB-C CONFIGURATION .....                                   | 169 |
| USB-C ANDROID CONFIGURATION .....                           | 170 |
| USB-C APPLE CONFIGURATION .....                             | 176 |
| USB-C ETHERNET CONFIGURATION .....                          | 183 |
| POWER .....   | 186 |
| ATTACHING THE BATTERY .....                                 | 186 |
| REMOVING THE BATTERY .....                                  | 186 |
| POWER COMPONENTS .....                                      | 186 |
| AUTO BOOT ON POWER .....                                    | 186 |
| POWER CONSUMPTION .....                                     | 186 |
| POWER PRIORITY .....  | 187 |
| TURNING ON THE CAMERA .....                                 | 187 |
| TURNING OFF THE CAMERA .....                                | 188 |
| MEDIA MANAGEMENT .....                                      | 188 |
| EJECTING MEDIA .....  | 188 |
| INSERTING MEDIA .....                                       | 190 |
| SECURE FORMAT .....   | 192 |
| MEDIA INFORMATION .....                                     | 193 |
| FILE SYSTEM .....   | 193 |
| CLIP FOLDER NAMING CONVENTION .....                         | 194 |
| CLIP METADATA .....   | 194 |
| MEDIA BEST PRACTICES .....                                  | 195 |
| RED MONITOR INTERFACE CABLE .....                           | 196 |
| MONITORING .....  | 196 |
| DSMC3™ RED® TOUCH 7.0" LCD .....                            | 196 |
| SDI OUTPUT TO A MONITOR .....                               | 197 |
| RED CONTROL .....   | 199 |
| USB-C .....   | 200 |
| EXPOSURE .....  | 201 |
| FALSE COLOR EXPOSURE TOOLS .....                            | 201 |
| FOCUS .....   | 202 |
| FOCUS PEAKING MODE .....                                    | 202 |
| EDGE PEAKING MODE .....                                     | 202 |
| PEAKING PEAKING MODE .....                                  | 203 |
| TIMECODE .....  | 203 |
| TIME OF DAY .....   | 203 |
| EDGE CODE .....   | 204 |
| ZEBRA MODES .....   | 206 |
| ZEBRA OVERVIEW .....  | 206 |
| PRE-RECORDING CONTENT .....                                 | 207 |
| CALIBRATING THE SENSOR .....                                | 208 |
| WHEN TO CALIBRATE THE SENSOR .....                          | 208 |
| UPGRADING THE FIRMWARE .....                                | 208 |
| VERIFYING THE FIRMWARE VERSION .....                        | 208 |
| UPGRADING THE FIRMWARE .....                                | 208 |
| UPGRADING THE DSMC3™ RED® TOUCH<br>7.0" LCD FIRMWARE .....  | 211 |

|  |     |
|--|-----|
| UPDATING AUTOMATICALLY THROUGH THE<br>CAMERA ..... | 211 |
| UPDATING MANUALLY THROUGH SMALLHD .....            | 211 |
| SYSTEM MAINTENANCE .....                           | 212 |

## 6. TROUBLESHOOTING

|                                    |     |
|------------------------------------|-----|
| GENERAL TROUBLESHOOTING TIPS ..... | 214 |
| CONTACT SUPPORT .....              | 214 |
| STATUS ICONS .....                 | 215 |

### A. MECHANICAL DRAWINGS

|                               |     |
|-------------------------------|-----|
| FRONT VIEW .....              | 217 |
| BACK VIEW .....               | 218 |
| RIGHT SIDE VIEW .....         | 219 |
| LEFT SIDE VIEW .....          | 220 |
| TOP VIEW .....                | 221 |
| BOTTOM VIEW .....             | 222 |
| FEMALE RP SMA PORT .....      | 223 |
| USB-C PORT .....              | 224 |
| 12G-SDI (SDI-1 & SDI-2) ..... | 225 |
| AUDIO PORT .....              | 227 |
| HEADPHONE JACK .....          | 228 |
| 6-PIN DC-IN .....             | 229 |
| EXTENSION PORT .....          | 230 |

### B. MENU MAP .....

### C. TECHNICAL SPECIFICATIONS .....

### D. ACCESSORIES

|   |     |
|---|-----|
| CFEXPRESS TYPE B MEDIA .....                  | 237 |
| RED® CFEXPRESS TYPE B READER .....            | 238 |
| REDOVOLT BATTERIES .....                      | 239 |
| REDOVOLT MICRO-V BATTERY .....                | 239 |
| REDOVOLT MICRO-G BATTERY .....                | 240 |
| RED® COMPACT CHARGERS .....                   | 241 |
| RED® COMPACT DUAL V-LOCK CHARGER .....        | 241 |
| RED® COMPACT DUAL GOLD MOUNT<br>CHARGER ..... | 242 |
| V-RAPTOR™ POWER ADAPTOR .....                 | 242 |
| DSMC3™ RED® TOUCH 7.0" LCD .....              | 243 |
| SPECIFICATIONS .....                          | 243 |
| DSMC3™ RED® TOUCH 7.0" LCD HOOD .....         | 244 |
| DSMC3™ RMI CABLES .....                       | 245 |
| V-RAPTOR™ TOP HANDLE AND<br>EXTENSIONS .....  | 245 |
| INSTALLING THE TOP HANDLE .....               | 246 |
| V-RAPTOR™ WING GRIP .....                     | 249 |
| OUTRIGGER HANDLE .....                        | 249 |
| RED® PRODUCTION GRIPS .....                   | 249 |
| V-RAPTOR™ SIDE RIBS .....                     | 250 |

|   |     |
|---|-----|
| V-RAPTOR™ EXPANDER BLADE .....  | 251 |
| DSMC3™ RED® 5-PIN TO SINGLE 3.5 MM<br>ADAPTER .....                                 | 252 |
| DSMC3™ RED® 5-PIN TO DUAL XLR<br>ADAPTER .....                                      | 252 |
| RED® RF TO PL ADAPTER PACK .....  | 253 |
| V-RAPTOR™ QUICK RELEASE PLATFORM<br>PACK .....                                      | 254 |
| V-RAPTOR™ TACTICAL TOP PLATE AND<br>BATTERY ADAPTER (V-LOCK OR GOLD<br>MOUNT) ..... | 257 |

## DISCLAIMER

RED® has made every effort to provide clear and accurate information in this document, which is provided solely for the user's information. While thought to be accurate, the information in this document is provided strictly "as is" and RED will not be held responsible for issues arising from typographical errors or user's interpretation of the language used herein that is different from that intended by RED. All information is subject to change as a result of changes in local, federal or other applicable laws.

RED reserves the right to revise this document and make changes from time to time in the content hereof without obligation to notify any person of such revisions or changes. In no event shall RED, its employees or authorized agents be liable to you for any damages or losses, direct or indirect, arising from the use of any technical or operational information contained in this document.

This document was generated on 3/9/2023. To see earlier versions of this document, submit a Support ticket at <https://support.red.com>.

For comments or questions about content in this document, send a detailed email to [OpsGuides@red.com](mailto:OpsGuides@red.com).

### COPYRIGHT NOTICE

COPYRIGHT© 2023 RED.COM, LLC

All trademarks, trade names, logos, icons, images, written material, code, and product names used in association with the accompanying products are the copyrights, trademarks, or other intellectual property owned and controlled exclusively by RED.COM, LLC. For a comprehensive list, see [www.red.com/trademarks](http://www.red.com/trademarks).

### TRADEMARK DISCLAIMER

All other company, brand, and product names are trademarks or registered trademarks of their respective holders. RED has no affiliation to, is not associated with or sponsored by, and has no express rights in third-party trademarks. Adobe and Adobe Premiere Pro are registered trademarks of Adobe Systems Incorporated. DaVinci and DaVinci Resolve are registered trademarks of Blackmagic Design in the U.S. and other countries. Leica is a registered trademark of Leica Microsystems. Canon is a registered trademark of Canon, U.S.A. Apple, iOS, Macintosh, Final Cut Pro, and QuickTime are registered trademarks of Apple Inc. in the U.S. and other countries. Windx is a registered trademark of S. C. Johnson & Son, Inc. Windows is a registered trademark of Microsoft Corporation. Avid is a registered trademark of Avid Technology, Inc. FileZilla is a registered trademark of its respective owners. Nuke™ is a trademark of The Foundry Visionmongers Ltd. SCRATCH is a registered trademark ® of ASSIMILATE, 2006. SCRATCH SCAFFOLDS, SCRATCH EXTENSIONS, and SCRATCH Digital Intermediate Process Solution are all trademarks and registered trademarks of ASSIMILATE, 2006, All rights reserved. Autodesk, the Autodesk logo, Flame are registered trademarks or trademarks of Autodesk, Inc., and/or its subsidiaries and/or affiliates in the USA and/or other countries.

### COMPLIANCE STATEMENTS

#### INDUSTRIAL CANADA EMISSION COMPLIANCE STATEMENTS

This device complies with Industry Canada license-exempt RSS standards RSS 139 and RSS 210. Operation is subject to the following two conditions: (1) this device may not cause interference, and (2) this device must accept any interference, including interference that may cause undesired operation of the device.

This Class B digital apparatus complies with Canadian ICES-003.

To comply with FCC and Industry Canada RF exposure limits for general population/ uncontrolled exposure, the antenna(s) used for this transmitter must be installed to provide a separation distance of 70 mm from all persons and operating in conjunction with any other antenna or transmitter, except in accordance with FCC multi-transmitter product procedures.

Other user manual statements may apply.

Le présent appareil est conforme aux CNR d'Industrie Canada applicables aux appareils radio exempts de licence. L'exploitation est autorisée aux deux conditions suivantes : (1) l'appareil ne doit pas produire de brouillage, et (2) l'utilisateur de l'appareil doit accepter tout brouillage radioélectrique subi, même si le brouillage est susceptible d'en compromettre le fonctionnement.

Cet appareil numérique de la classe B est conforme à la norme NMB-003 du Canada.

Pour se conformer aux limites d'exposition aux RF de la FCC et d'industries Canada pour la population générale/ exposition non contrôlée, l'antenne(s) utilisée pour ce transmetteur doit être installée pour fournir une distance de séparation d'au moins 70 mm de toutes les personnes et fonctionnant conjointement avec une autre antenne ou émetteur, sauf en conformité avec les procédures de produits multi-émetteur FCC.

Autres d'éclairations manuel de l'utilisateur peuvent s'appliquer.

### FEDERAL COMMUNICATIONS COMMISSION (FCC) STATEMENTS



This equipment has been tested and found to comply with the limits for a Class A digital device, pursuant to part 15 of the FCC Rules. These limits are designed to provide reasonable protection against harmful interference when the equipment is operated in a commercial environment. This equipment generates, uses,

and can radiate radio frequency energy and, if not installed and used in accordance with the instruction manual, may cause harmful interference to radio communications. Operation of this equipment in a residential area is likely to cause harmful interference in which case the user will be required to correct the interference at his own expense.

To maintain compliance with FCC regulations, shielded cables must be used with this equipment. Operation with non-approved equipment or unshielded cables is likely to result in interference to radio and TV reception. The user is cautioned that changes and modifications made to the equipment without the approval of manufacturer could void the user's authority to operate this equipment.

This device complies with Part 15 of the FCC Rules.

Operation is subject to the following two conditions (1) this device may not cause harmful interference, and (2) this device must accept any interference received, including interference that may cause undesired operation.



**CAUTION:** Exposure to Radio Frequency Radiation.

The device shall be used in such a manner that the potential for human contact is minimized.

This equipment complies with FCC radiation exposure limits set forth for an uncontrolled environment. This equipment should be installed and operated with a minimum distance of 20 cm between the radiator and your body.



**CAUTION:** Regulations of the FCC and FAA prohibit airborne operation of radio-frequency wireless devices because their signals could interfere with critical aircraft instruments.



**CAUTION:** If the device is changed or modified without permission from RED, the user may void his or her authority to operate the equipment.

## AUSTRALIA AND NEW ZEALAND STATEMENTS

RED declares that the radio equipment described in this document complies with the following international standards:

- IEC 62368-1 – Product Safety
  - ETSI EN 300 328 – Technical requirement for radio equipment
- RED declares digital devices described in this document comply with the following Australian and New Zealand standards:

- AS/NZS CISPR 32 – Electromagnetic Interference
- AS/NZS 61000.3.2 – Power Line Harmonics
- AS/NZS 61000.3.3 – Power Line Flicker

## EUROPEAN UNION COMPLIANCE STATEMENTS



RED declares that the radio equipment described in this document complies with the EMC Directive (2014/30/EU) and the Low Voltage Directive (2014/35/EU) issued by the Commission of the European Community. Compliance with this directive implies

conformity to the following European Norms (in brackets are the equivalent international standards).

- EN 62368-1 (IEC 62368-1) – Product Safety
- ETSI EN 300 328 Technical requirement for radio equipment
- ETSI EN 301 489 General EMC requirements for radio equipment
- EN 55032 (CISPR 32) Electromagnetic Compatibility
- EN 55035 (CISPR 35) Immunity Requirements
- EN 61000-3-2 (IEC 61000-3-2) Harmonic Current Emissions
- EN 61000-3-3 (IEC 61000-3-3) Voltage changes, voltage fluctuations and flicker
- EU 2015/863 RoHS Directive

## WASTE ELECTRICAL AND ELECTRONIC EQUIPMENT (WEEE)

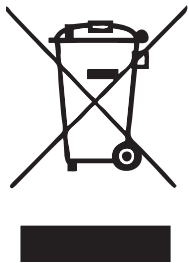

The Waste Electrical and Electronic Equipment (WEEE) mark applies only to countries within the European Union (EU) and Norway. This symbol, on the product and accompanying documents, means that used electrical and electronic products should not be mixed with general household waste. For proper treatment, recovery and recycling, take this product to designated collection points where it will be accepted free of charge. Alternatively, in some countries you may be able to return your

products to your local retailer upon purchase of an equivalent new product.

Disposing of this product correctly will help save valuable resources and prevent any potential negative effects on human health and the environment, which could otherwise arise from inappropriate waste handling. Contact your local authority for further details of your nearest designated collection point. Penalties may be applicable for incorrect disposal of this waste, in accordance with your national legislation.

For business users in the European Union, if you wish to discard electrical and electronic equipment, contact your dealer or supplier for further information.

## RESPONSIBLE PARTY

RED Digital Cinema  
94 Icon  
Foothill Ranch, CA 92610  
USA

# SAFETY INSTRUCTIONS

- This equipment is intended to be used by instructed personnel and is not intended to be used by children.
- DO NOT use the camera or accessories near water. Avoid exposing your camera to moisture. The unit is not waterproof, so contact with water could cause permanent damage to the unit as well as electric shock and serious injury to the user. DO NOT use the camera in the rain or under other conditions with high moisture without appropriate protection, and immediately remove power source if camera or accessories are exposed to moisture.



**WARNING:** To reduce the risk of fire or electric shock, do not expose the camera to rain or moisture.

- DO NOT point the camera directly into extreme light sources such as the sun or lasers. Permanent damage to optical path or sensor may occur, which is not covered by manufacturer's warranty.
- DO NOT expose your camera to excessive vibration or impact (shock). Be careful not to drop your camera. Internal mechanisms may be damaged by severe shock. Mechanical alignment of optical elements may be affected by excessive vibration.
- ELECTROMAGNETIC INTERFERENCE: The use of devices using radio or other communication waves may result in the malfunction or interference with the unit and/or with audio and video signals.
- Clean only using a dry cloth. When cleaning your camera, remember that it is not waterproof and moisture can damage electronic circuitry. DO NOT rinse or immerse any element of the camera, lens or other accessory, keep them dry at all times. DO NOT use soaps, detergents, ammonia, alkaline cleaners, and abrasive cleaning compounds or solvents. These substances may damage lens coatings and electronic circuitry.
- Maintain sufficient ventilation—DO NOT block any ventilation openings or obstruct cooling fan airflow.



**CAUTION:** Proper camera ventilation requires a minimum 0.5" (1.25 cm) clearance between the camera ventilation openings and external surfaces. Verify that objects that can block the fan intake and exhaust ports do not impede airflow. Failure to permit adequate airflow may result in overheating of the camera, degraded operation, and in extreme situations, damage to the camera.



**WARNING:** Media cards can become very hot during prolonged recording sessions. When ejecting the media card, let it cool before touching it with bare fingers.

- DO NOT operate or store near any heat sources such as radiators, heat registers, stoves, or any other apparatuses that produce heat. Store in a protected, level and ventilated place. Avoid exposure to temperature extremes, damp, severe vibration, strong magnetic fields, direct sunlight or local heat sources during storage. Remove any batteries from the camera before storage. Recommended storage and usage temperatures for your camera, lenses and other accessories are:

- Operating range: 32° F to 104° F (0° C to 40° C)
- Storage range: -4° F to 122° F (-20° C to 50° C)

- If there are any performance issues with your camera or accessories when operating within this temperature range, submit a support ticket to <https://support.red.com>.
- DO NOT bypass the third prong of the grounding-type plug on the power cord of the included power adaptor. A grounding-type plug has two blades and a third “grounding” prong. The third prong is provided for your safety. You must connect the plug to an outlet with a protective earth connection. If the grounding-type plug does not fit into your outlet, do not attempt to modify the plug or outlet, consult a qualified electrician.
- Protect all power cords from being pinched, walked on, or driven over by a vehicle. Replace any power cords suspected of sustaining damage due to crushing or other forms physical damage.



**CAUTION:** Install this camera in a proper support system that can handle the entire weight of the camera and the accessories. Secure the camera by using the ¼-20 and/or the 3/8-16 mounting points located on the bottom of the camera. Always verify that the screws are tightened properly. When the camera is not properly attached, or is placed on an unstable surface, the camera can fall and cause injury or be damaged.



**CAUTION:** Products marked with this symbol are Class 2 devices. These double insulated devices are not provided with a grounding type plug.



**CAUTION:** The power cord plug for the included power adaptor is used as the power disconnect. To disconnect all power from the power adaptor, unplug the power cord plug from the wall outlet. During use, the power cord plug should remain easily accessible at all times.

- Lithium-ion batteries may be subject to special handling requirements pursuant to federal and local laws. Refer to specific shipping instructions included with your battery regarding proper transport of your battery. Do not handle your battery if it is damaged or leaking. Disposal of batteries must be in accordance with local environmental regulations. For example, California law requires that all rechargeable batteries must be recycled by an authorized recycle center. Storing batteries fully charged or in high temperature conditions may permanently reduce the life of the battery. Available battery capacity may also be temporarily lessened after storage in low temperature conditions.



**WARNING:** DO NOT expose the battery to excessive heat.



**CAUTION:** Refer all service and repair to qualified RED service personnel. To reduce the risk of electric shock, and damage to the camera or accessories, DO NOT attempt to perform any servicing other than any procedures that are recommended in the operating instructions.



**INDOOR USE ONLY:** This device is designed primarily for indoor use.

## BATTERY STORAGE AND HANDLING



**WARNING:** Failure to read, understand, and follow these instructions may result in overheating, chemical leakage, smoke emission, fire, or other potentially harmful results.



**WARNING:** Only replace the battery with a battery of the same type, or with a battery that is equivalent.

- Read and adhere to all safety instructions provided by the manufacturer of the batteries.
- Always follow proper battery handling and storage practices. Improper handling and failure to abide by proper storage instructions may cause permanent damage to batteries, or degrade battery charge holding capacity. Improper handling practices or failure to comply with instructions may also put you at risk.
- Lithium-Ion batteries, like the REDVOLT Micro-V, self-discharge over time. When storing for long periods of time, store batteries separately from the camera or charger and remember to charge batteries to a capacity level of 40% to 60%. If batteries will be stored for long periods of time, RED recommends that you check the charge level at least once every six (6) months, and recharge batteries to a capacity level of 40% to 60%.
- When not in use, remove the battery from the camera or charger and store the battery in a cool, dry place. Avoid extreme hot temperatures (such as inside a hot car), corrosive gas, and direct sunlight. The optimal storage temperature for batteries is between -4° F to 68° F (-20° C to 20° C).



**WARNING:** Batteries stored in a discharged state for long periods of time may self-discharge and lose the ability to hold a charge.



**WARNING:** If recharging operation fails to complete even after a specified recharging time has elapsed, immediately stop further recharging.

- DO NOT store batteries in a fully charged state for extended periods of time.
- DO NOT store batteries in a fully discharged state for extended periods of time.
- DO NOT store batteries in the camera or in a charger for extended periods of time.
- DO NOT use batteries for purposes other than their intended use.
- DO NOT store batteries in extreme hot or cold temperatures.
- DO NOT store batteries in direct sunlight.
- DO NOT disassemble or modify the battery.
- DO NOT overcharge batteries. Overcharging may increase internal temperature beyond the recommended limits and cause permanent damage to the battery.
- DO NOT connect the positive (+) and negative (-) terminals to a metal object such as a wire.
- DO NOT transport or store the battery together with metal objects such as jewelry, hairpins, etc. as they may generate heat if they come into contact with the battery.
- DO NOT discard the battery into fire or heat.
- DO NOT store, use, or recharge the battery near a heat source such as a fire or a heater.
- DO NOT allow the battery to get wet.
- DO NOT pierce the battery with pointed or other sharp objects.

- DO NOT step on, throw, or strike the battery with a hammer.
- DO NOT use a battery that appears to be deformed or damaged.
- DO NOT directly solder the battery.
- DO NOT put the battery into a microwave oven or a pressurized container.
- DO NOT use or subject the battery to intense sunlight or hot temperatures such as in a car in hot weather.
- DO NOT use it in a location where static electricity may be present.
- DO NOT exceed the recharging temperature range of 32° F to 104° F (0° C to 40° C).
- Store the battery in a location where children cannot reach it.
- If the battery leaks or gives off a bad odor, discontinue use immediately.
- If the battery gives off an odor, generates heat, becomes discolored or deformed, or in any way appears abnormal during use, recharging or storage, immediately remove it from the equipment or battery charger and discontinue use.
- If electrolyte begins leaking from the battery and comes into contact with your skin or clothing, immediately wash it away with running water. Failure to do this may result in skin inflammation.
- If the battery leaks and the electrolyte reaches the eyes, do not rub them. Instead, rinse the eyes with clean running water and immediately seek medical attention. Failure to do this may result in eye injury.



# 1. INTRODUCTION



Figure: V-RAPTOR 8K S35 camera

## V-RAPTOR™ 8K S35

RED's V-RAPTOR™ 8K S35 is another addition into the RED® DSMC3 generation of cameras. Building on the same architecture of the V-RAPTOR™ 8K VV, the V-RAPTOR™ 8K S35 offers a new shooting format while leveraging the improvements in color science and performance of its larger 8K VV predecessor.

Featuring an 8K sensor optimized for Super 35 mm lenses, V-RAPTOR™ 8K S35 offers filmmakers a unique benefit of using the versatile range of Super 35 mm lenses while still capturing in the smooth true-to-life detail that only 8K resolution provides. Create stunning slow-motion imagery at 120 fps using the full 8K Super 35 mm field of view, or slow it down to 600 fps at 2K. With over 16.5 stops of dynamic range, V-RAPTOR™ 8K S35 is ready to capture stunning imagery in all types of environments. V-RAPTOR™ 8K S35 also continues to feature RED's proprietary REDCODE RAW codec, allowing users to capture 16-bit RAW, and leverage RED's latest IPP2 workflow and color management.

The 8K S35 sensor sits inside the same camera body as V-RAPTOR™ 8K VV, offering the same horsepower and flexibility filmmakers have come to rely on. The V-RAPTOR™ features a modernized platform in an amazingly compact package weighing in at barely over 4 lbs. With two 4K 12G-SDI outputs, XLR audio and phantom power (using a breakout adapter), and 1080p livestream, this system can handle most anything a shooter can throw at it.

## QUICK REFERENCE

Refer to the [Quick Reference](#) section to get familiar with this guide and the camera.

## R3D FILE FORMAT AND REDCODE

All videos and frames are recorded to the R3D® file format. The R3D file format was developed by RED to provide an efficient and manageable RAW video data format that promotes advanced post-production editing capabilities. In the R3D file format, the digital image received from the sensor is formatted as a pixel-defect corrected (but in all other aspects unprocessed) 16-bit per pixel RAW data frame. Each RAW frame, or sequence of RAW frames in a clip, is compressed using proprietary REDCODE® RAW compression, then stored to media.

RAW data is recorded independently of any RGB domain color processing such as ISO, White Balance, or other RGB color space settings. Instead, color parameters are saved as reference metadata; that is, color is not burned into the recorded RAW data. This innovative recording technique promotes flexibility in RGB color processing. It allows you to defer color correction to post-production, or to adjust the image color in the field, without changing the recorded RAW data image quality or dynamic range.

REDCODE is a compression codec that reduces R3D RAW files down to a manageable size, allowing the media to record longer. The ability to compress RAW data is one of the significant technological advances that RED has brought to the motion picture industry.

## IMAGE PROCESSING PIPELINE

This camera uses RED's Image Processing Pipeline 2 (IPP2). In IPP2, the advanced RED color space (REDWideGamutRGB) allows the camera to use every color that the sensor can generate up to the clipping threshold. Then the camera encodes the image using Log3G10, a gamma curve that retains extreme highlight and shadow detail. Using the advanced color space and gamma curve, RED IPP2 allows you to grade and make color adjustments in post-production, instead of in-camera. IPP2 also allows the camera to use a [CDL](#) for grading. For more information about IPP2, refer to the [RED IPP2](#) support page.

## SHOOT FOR VIDEO AND STILLS

High resolution video, such as the digital footage captured by the camera, has surpassed the detail necessary to produce professional full-sized prints. Because the camera is able to record RAW video at high frame rates and resolution, this camera is ideally suited to capture video and still images simultaneously while still preserving the full flexibility that RAW still photographers have come to expect.

## POST-PRODUCTION

Many non-linear editing systems (NLEs) can open and edit RED footage, allowing full RAW control and flexibility without any need to re-transcode. Each NLE version may have specific compatibility requirements, such as camera firmware version or camera type. Before shooting, make sure you check all of the compatibility requirements.

You can open and/or edit R3D files by using one of the following products:

- **REDCINE-X PRO:** RED's proprietary application. Download [REDCINE-X PRO for Windows](#) or [REDCINE-X PRO for Mac](#) from [www.red.com/downloads](http://www.red.com/downloads).
- **Adobe Premiere Pro**
- **Avid Media Composer**
- **DaVinci Resolve**
- **Final Cut Pro X:** Requires you to download the [RED Apple Workflow Installer](#) from [www.red.com/downloads](http://www.red.com/downloads).
- **Adobe PhotoShop:** Can open .R3D files, however, you must download the [RED Adobe PhotoShop Installer for Windows](#) or [RED Adobe PhotoShop Installer for Mac](#) from [www.red.com/downloads](http://www.red.com/downloads).
- **Foundry Nuke**
- **Assimilate Scratch**
- **AutoDesk Flame**
- **ColorFront Transkoder** (beta for latest support)

**NOTE:** Third-party applications may have limited compatibility with R3D files. Third-party developers must use the most recent [R3D SDK](#) to offer compatibility with the latest RED firmware.

## POST-PRODUCTION WITH REDCINE-X PRO

REDCINE-X PRO is a professional one-light coloring tool set, equipped with an integrated time line, and with a collection of post effects software. REDCINE-X PRO provides the ideal environment to review recorded footage, edit metadata, organize projects, and prepare your R3D files. You can use REDCINE-X PRO or any of the compatible third-party NLEs to edit R3D files.

## ADDITIONAL RESOURCES

- **RED.com:** Visit the [official RED website](#) for the latest information about RED products.
- **RED Downloads:** Go to [RED Downloads](#) to download the latest firmware, operation guides, and post-production software.
- **RED 101 Articles:** RED offers [in-depth technical articles](#) about RED cameras, post-production, and digital cinematography.
- **RED TECH Videos:** RED offers [videos](#) about understanding and using RED cameras.
- **RED Support:** Visit the [RED SUPPORT site](#) for support articles or to file a support ticket.

## 2. QUICK REFERENCE

Congratulations new RED V-RAPTOR™ 8K S35 camera owner. This quick reference topic helps you get familiar with this guide and the [Camera Body](#). It includes links to topics about configuring the camera to fit your recording requirements, and for learning the basic operation of the camera.

### PREPARING THE CAMERA HARDWARE

Prepare the camera hardware for recording by:

- Attaching accessories (refer to [Accessories](#))
- Installing [Lenses and Adapters](#)
- [Inserting Media](#)
- Connecting a power source (refer to [Power](#) or [REDOVOLT Batteries](#))
- [Turning On the Camera](#)

### PREPARING THE CAMERA SYSTEM

Configure the camera settings to prepare for recording by:

- Configuring the camera system settings (refer to the [System Settings Menu](#))
- [Upgrading the Firmware](#) and [Upgrading the DSMC3™ RED® Touch 7.0" LCD Firmware](#)
- Calibrating the camera using the [Calibrate](#) feature
- Formatting the media (refer to [Secure Format](#))
- Specifying the desired recording resolution (refer to [Format](#))
- Configuring the [Recording Frame Rate](#) and [Project Time Base](#)
- Setting the exposure (refer to [Shutter](#))
- Configuring the monitoring tools and reviewing the monitored image (refer to the [Monitoring Menu](#))
- Reviewing the camera status (refer to [System Status](#))

### RECORDING

Start recording your project.

- Record by pressing the REC button on the [Camera Body](#) or [Outrigger Handle](#)
- Record by using the Top LCD (refer to [DSMC3™ RED® Touch 7.0" LCD](#))
- Record by using an external trigger (refer to [Extension Port](#))
- Start, stop, and control the camera by using USB-C (refer to [USB-C Configuration](#))
- Start, stop, and control the camera by using Wi-Fi (refer to [How-To](#))

### PROCESSING FOOTAGE

Perform post-production using any of the standard applications.

- Adobe® Premiere® Pro
- Avid® Media Composer®
- DaVinci Resolve®
- Final Cut Pro X®

**NOTE:** Third-party applications may have limited compatibility with R3D files. Third-party developers must use the most recent [R3D SDK](#) to offer compatibility with the latest RED firmware.

## 3. CAMERA COMPONENTS

The camera components include the camera body, lenses and adapters, and camera LCD.

### CAMERA BODY

This section describes the **Front**, **Back**, **Left**, **Right**, **Top**, and **Bottom** of the camera, and identifies the controls, buttons, **Camera Body LEDs**, and the lens mount on the body.

### CAMERA BODY CONTROLS AND FEATURES

This section describes the controls and features of the camera.

#### FRONT



Figure: Camera Body Front Controls and Features

| # | ITEM           | DETAILS   |
|---|----------------|---|
| 1 | Mounting holes | Two upper 1/4"-20 mounting holes  |
| 2 | Lens release   | Press to release RF-type lenses   |
| 3 | Locking ring   | Rotate to lock and unlock lenses  |
| 4 | REC button     | Press to select recording modes or alternate programmable functions                       |
| 5 | Tally light    | Indicates that the camera is recording (refer to <b>Camera Body LEDs and Indicators</b> ) |
| 6 | Mounting holes | Eight lower 1/4"-20 mounting holes  |

## BACK



Figure: Camera Body Rear Controls and Features

| # | ITEM                        | DETAILS  |
|---|-----------------------------|--|
| 1 | Antenna                     | Male RP SMA Wi-Fi antenna mounted to a female RP SMA connector. Supports 2.4 GHz and 5 GHz |
| 2 | USB-C port                  | USB-C connection   |
| 3 | 12G-SDI port 1              | Full-size 12G-SDI BNC port for SDI monitor connection <sup>1,2</sup>                       |
| 4 | 12G-SDI port 2              | Full-size 12G-SDI BNC port for SDI monitor connection <sup>1,2</sup>                       |
| 5 | Audio port/LED              | 5-Pin 00B ODU for 2 channel audio (Line, Mic, and +48V)                                    |
| 6 | Headphone port              | 3.5 mm stereo headphone jack   |
| 7 | DC-IN port                  | 6-Pin 1B ODU for DC-IN (11 to 17 volts) (refer to <b>6-Pin DC-IN</b> )                     |
| 8 | 9-Pin <b>Extension Port</b> | 9-Pin 0B ODU serial port for start/stop, Genlock, TC and RS-232                            |
| 9 | Micro V-Lock port           | 14.4 V Micro V-Lock battery mount (refer to <b>REDVOLT Batteries</b> )                     |

1. Use certified 12G-SDI cables.

2. **WARNING:** Always connect the accessories' DC power cable (or batteries) before connecting the BNC SDI cable. Always remove the BNC SDI cable before removing the accessories' DC power cable (or batteries).

## LEFT

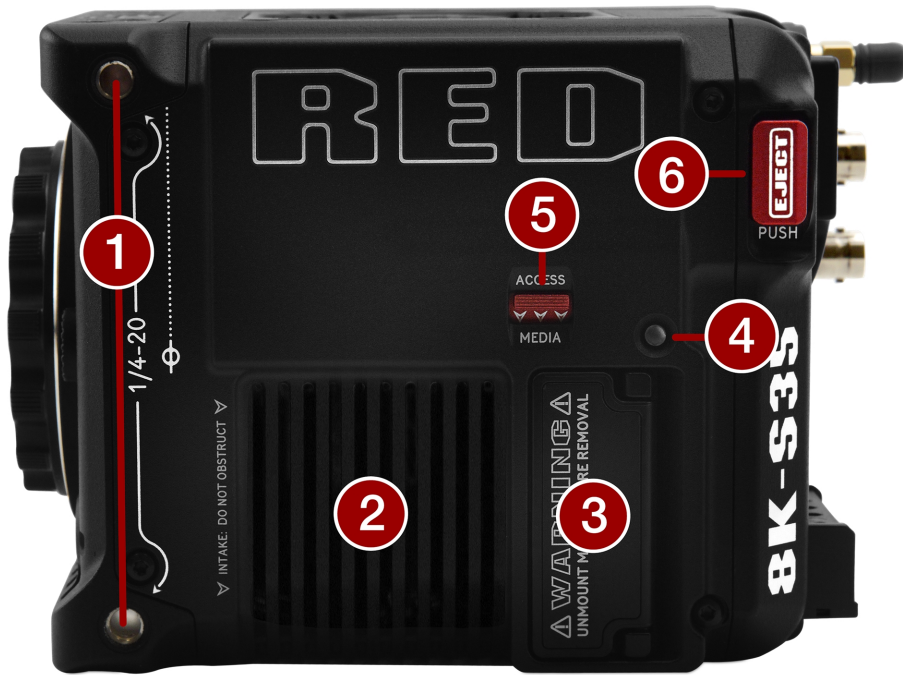

Figure: Camera Body Left Controls and Features

| # | ITEM              | DETAILS   |
|---|-------------------|---|
| 1 | Mounting holes    | Two side 1/4-20 mounting holes  |
| 2 | Intake            | Cooling fan air intake  |
| 3 | Media compartment | Covered CFexpress Type B compartment                                    |
| 4 | CFexpress LED     | CFexpress status indicator (refer to <a href="#">Camera Body LEDs</a> ) |
| 5 | Access media      | Latch for the CFexpress Type B media compartment door                   |
| 6 | EJECT button      | Eject button for Micro V-Lock battery                                   |

## RIGHT



Figure: Camera Body Right Controls and Features

| # | ITEM                 | DETAILS   |
|---|----------------------|---|
| 1 | Power switch and LED | Slide up to turn on the camera and slide down to turn off the camera. LED displays the camera ready status (refer to <a href="#">Camera Body LEDs</a> ) |
| 2 | Menu LCD             | GUI menu screen and buttons   |
| 3 | Mounting holes       | Two side 1/4"-20 mounting holes   |
| 4 | Speaker              | Beep speaker for audible feedback   |
| 5 | Record LED           | Displays the camera recording status (refer to <a href="#">Camera Body LEDs</a> )   |
| 6 | REC button           | Press and release the <b>REC</b> button to toggle between record start and stop   |
| 7 | Air intake           | Air intake for thermal management   |
| 8 | Focus plane          | Focus plane indicator symbol  |



TOP

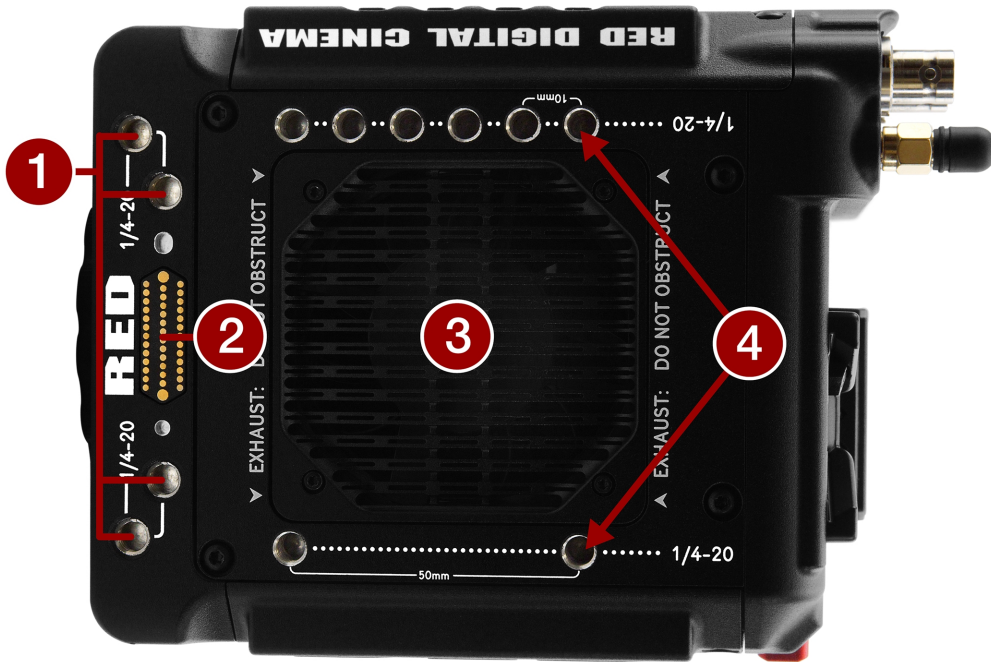

Figure: Camera Body Top Controls and Features

| # | ITEM           | DETAILS   |
|---|----------------|---|
| 1 | Mounting holes | Four top front 1/4"-20 mounting holes   |
| 2 | Accessory port | Connection port for accessories (refer to <a href="#">Outrigger Handle</a> , and <a href="#">DSMC3™ RED® Touch 7.0" LCD</a> ) |
| 3 | Exhaust        | Air exhaust for thermal management  |
| 4 | Mounting holes | Eight top side 1/4"-20 mounting holes   |

**BOTTOM**

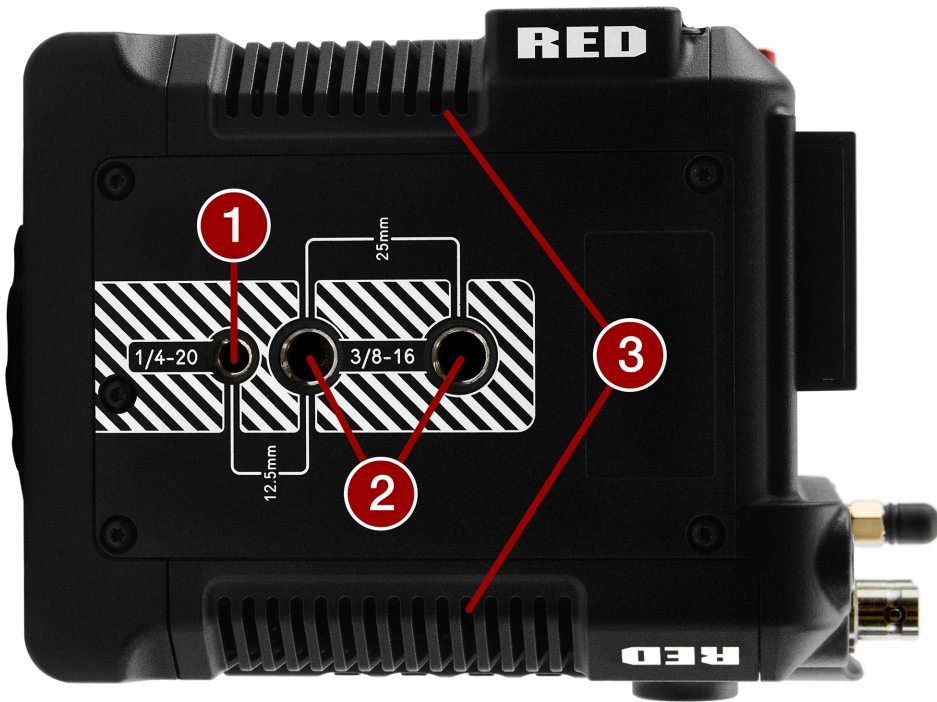

Figure: Camera Body Bottom Features

| # | ITEM            | DETAILS                            |
|---|-----------------|------------------------------------|
| 1 | Mounting point  | One (1) 1/4"-20 mounting hole      |
| 2 | Mounting points | Two (2) 3/8"-16 mounting holes     |
| 3 | Air intakes     | Air intakes for thermal management |

## CAMERA BODY LEDS

### FRONT LED



Figure: Camera LED, Front

| # | ITEM                | COLOR | DETAILS   |
|---|---------------------|-------|---|
| 1 | Tally indicator LED | Red   | When enabled, this LED is ON when the camera is recording. For information about enabling this LED, refer to <a href="#">Indicators</a> |

**BACK LEDS**



Figure: Camera, Back LEDs

| # | ITEM          | COLOR          | DETAILS  |
|---|---------------|----------------|--|
| 1 | Phantom power | Blue           | Indicates that the +48 V Phantom Power is enabled      |
| 2 | DC-IN         | Green          | DC-IN is present and / or the battery is fully charged |
|   |               | Flashing amber | Communicating with, and evaluating, the battery        |
|   |               | Amber          | Charging connected battery                             |
|   |               | Red            | Error charging the battery                             |

## LEFT SIDE LED



Figure: Camera LED, Left Side

| # | ITEM                | COLOR/FLASHING      | DETAILS  |
|---|---------------------|---------------------|--|
| 1 | CFexpress media LED | Off                 | No media mounted   |
|   |                     | Green               | Preview; media mounted with > 10% of media space available |
|   |                     | Amber               | Recording finalizing or playback mode                      |
|   |                     | Amber flashing slow | Formatting media   |
|   |                     | Red flashing slow   | Media mounted with >5% and <= 10% of media space available |
|   |                     | Red flashing fast   | Media mounted with <= 5% of media space available          |
|   |                     | Red                 | Recording with > 10% of media space available              |

## RIGHT SIDE LEDS



Figure: Camera LEDs, Right Side

| # | ITEM                    | COLOR/FLASHING    | DETAILS  |
|---|-------------------------|-------------------|--|
| 1 | Power status (ON)       | Off               | Camera OFF   |
|   |                         | Amber             | Camera booting   |
|   |                         | Green             | Camera ON  |
|   |                         | Amber flashing    | Camera ON; 5 to 10 min of battery time available                         |
|   |                         | Red flashing      | Camera ON; < 5 min of battery time available                             |
|   |                         | Red               | Camera shutting down   |
| 2 | Record status (REC)     | Off               | No media present   |
|   |                         | Green             | Ready to record  |
|   |                         | Red               | Recording  |
|   |                         | Amber             | Finalizing   |
|   |                         | Red flashing slow | Media mounted with >5% and <= 10% of media space available               |
|   |                         | Red flashing fast | Media mounted with <= 5% of media space available                        |
| 3 | Power (firmware update) | Flashing green    | Firmware update in progress  |
|   |                         | Flashing red      | Firmware update error (refer to <a href="#">Upgrading the Firmware</a> ) |

## LENSES AND ADAPTERS

This section lists the compatible lenses and adapters for the camera. It also provides the steps for [Attaching Lenses](#) and [Removing Lenses](#).

For more information on a specific lens or adapter, refer to the original manufacturer's instructions.

**WARNING:** When the camera is not in use, protect lenses and the camera sensor by attaching the lens caps and camera mount cap.



*Figure: Camera with mount cap installed.*

Incompatible lenses do not register on the camera UI and they will not show any UI lens information or menu controls. The camera can control compatible lenses electronically, including the following features:

- Iris - The UI menu is enabled and the camera can control the lens Iris
- Autofocus - The UI menu is enabled for lenses that support autofocus
- Image Stabilization - The UI indicates that image stabilization is present
- Control Ring - The UI menu is enabled and the camera can use the control ring

For more information, refer to the [Lens](#) menu.

## COMPATIBLE LENSES

The latest RED-tested and approved lenses are listed on the V-RAPTOR section of [RED Support](#).

## LENS WEIGHT AND LENS SUPPORT

Use a lens support system when mounting heavy or long lenses to your camera.

When mounting a heavy or long lens, ensure that the full weight of the lens is never directly on the camera or lens mount. Mount the lens to the support system first, and then carefully mount the lens to the camera.

## COMPATIBLE MOUNT ADAPTERS

RED tested the following adapters and determined that they are compatible with the camera:

- RED® RF to PL Adapter (refer to [RED® RF to PL Adapter Pack](#))
- Canon Mount Adapter EF-EOS R
- Canon Drop-In Filter Mount Adapter EF-EOS R with Variable ND Filter / Clear Filter / Circular Polarizer

Refer to the V-RAPTOR section of [RED Support](#) for more information.

## ATTACHING LENSES

1. Unlock the locking ring by rotating it to the fully counterclockwise position.
2. Press and hold the lens release button on the camera. While holding the lens release button, turn the camera lens mount cap counter-clockwise until it stops, and remove it from the camera. If the lens locking ring rotates while removing the cap, make sure that you hold the locking ring tab in place while rotating the cap.
3. Remove the rear lens cap from the mount end of the lens.
4. Align the red dot on the lens mount with the red dot on the camera lens mount, and insert the lens mount of the lens in the camera lens mount opening.
5. Turn the lens clockwise until it clicks in place. If the lens locking ring rotates while attaching the lens, make sure that you hold the locking ring tab in place while rotating the lens or adapter.
6. Gently tighten the locking ring. **DO NOT OVER-TIGHTEN THE LOCKING RING.**
7. Store the camera lens mount cap and the rear lens cap together in a dust free location.

## REMOVING LENSES

1. Loosen the locking ring gently.
2. Press and hold the lens release button on the camera. While holding the lens release button, turn the lens counter-clockwise until it stops, and remove it from the camera. If the lens locking ring rotates while removing the lens, make sure that you hold the locking ring tab in place while rotating the lens or adapter.
3. Align the red dot on the camera lens mount cap with the red dot on the camera lens mount, and attach the cap to the camera.
4. Gently tighten the locking ring. **DO NOT OVER-TIGHTEN THE LOCKING RING.**
5. Attach the rear lens cap to the lens.
6. Store the lens with the front and rear caps attached.



## LCD



This section describes the graphical user interface (GUI) for the built-in camera side LCD. Durable controls enable convenient access to menus, camera features, and critical camera information.

## LCD NAVIGATION

Press the up and down arrows together to lock or unlock the LCD. When the LCD is locked, the Lock icon displays briefly whenever you push an LCD button.

Select items on the LCD screen by pressing the adjacent buttons:



In this example, pressing the button above FPS opens the Recording Frame Rate selection list:



Press the up and down arrows to navigate the list. Press the button below OK or press the SEL button to accept the choice and return to the Home Page. Press the button below CANCEL or press the MENU button to return to the Home Page without making a change. Press the button under EDIT to open a manual editing screen.

## MENUS

Press the MENU button from the Home Page to open the Menus:

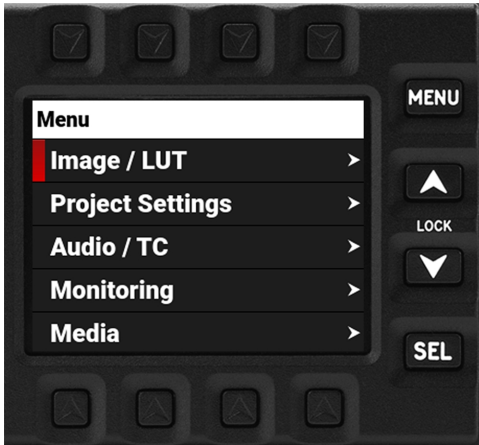

Press the up and down arrows to navigate up and down in the menu list. Press SEL to select a menu and open the submenus:

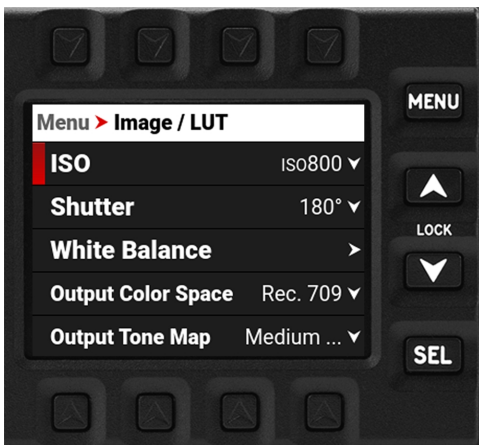

Press SEL to select a submenu and open a list of menu items:

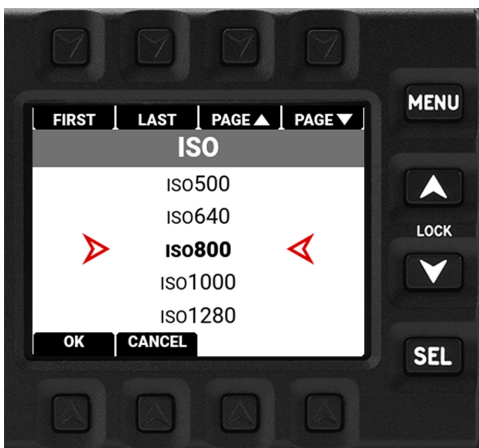

Press the buttons above FIRST, LAST, PAGE▲, or PAGE▼ or press the up or down arrow to navigate the list. Press SEL, or the button under OK, to select the item. Press MENU, or the button under CANCEL, to return to the menu without making a selection.

For more information about menus, refer to [Menus](#).

## PAGES

The LCD contains the Home Page, Histogram Page, Tools Page, SDI Page, Audio Channels 1 and 2 Page, Audio Channels 3 and 4 Page, Headphones Page, Sensor Sync Shift Page, and User Pages 1, 2, and 3.

Press the up arrow or down arrow to navigate through the pages. Select the pages you want the LCD to display by using the Side LCD menu (refer to [Side LCD Control Panels](#)).

## HOME PAGE

The Home Page contains the Recording Quick Settings, Exposure Meter, Recording Status, VU Meter, Status Bar, and Quick Menus (refer to [Home Page](#)).

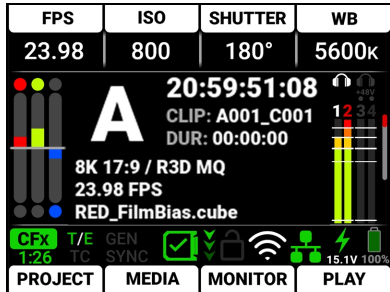

## HISTOGRAM PAGE

The Histogram Page contains the Autofocus Quick Settings, Exposure Meter, Histogram, and Lens Quick Settings (refer to [Histogram Page](#)).

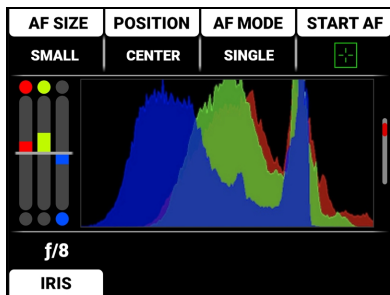

## TOOLS PAGE

The Tools Page contains the Peaking Tools, Exposure Tools, Zebra Tools, and Quick Monitor Menu (refer to [Tools Page](#)).

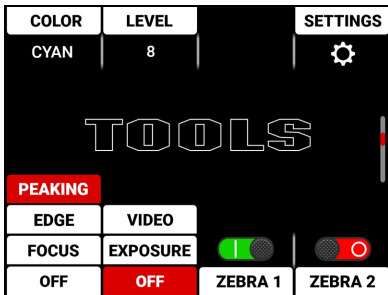

## SDI PAGE

The SDI Page contains the switches you use to enable or disable the SDI features, and the Look settings for SDI Port 1 and SDI Port 2 (refer to [SDI Page](#)).

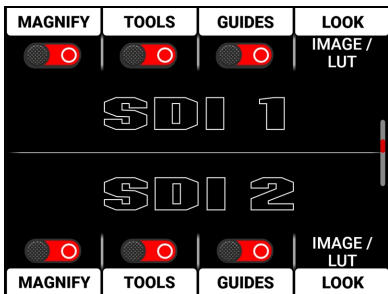

## AUDIO CHANNELS 1 / 2 PAGE

The Audio Channels 1 / 2 Page contains the settings for the internal microphone channels 1 and 2 (refer to [Audio Channels 1 / 2 Page](#)).

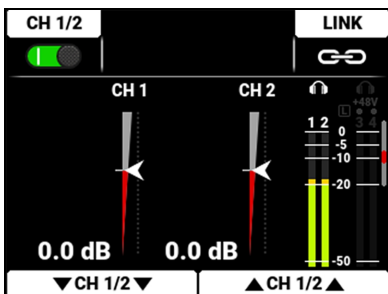

## AUDIO CHANNELS 3 / 4 PAGE

The Audio Channels 3 / 4 Page contains the settings for the external audio port channels 3 and 4 (refer to [Audio Channels 3 / 4 Page](#)).

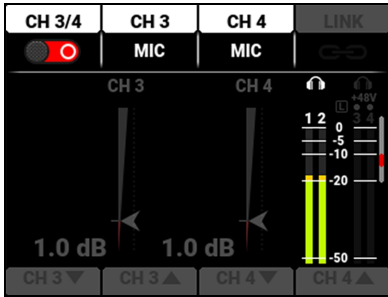

## HEADPHONE PAGE

The Headphone Page contains the settings for the headphone port audio output (refer to [Headphone Page](#)).

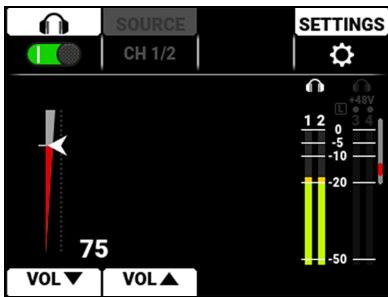

## SENSOR SYNC SHIFT PAGE

The Sensor Sync Shift page buttons allow you to quickly adjust the sensor sync shift (refer to [Sensor Sync Shift Page](#)).

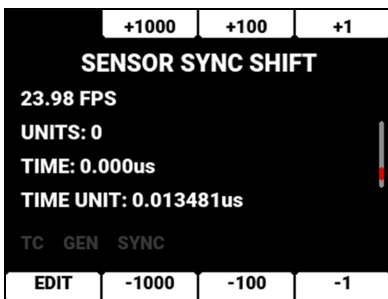

## USER PAGES

The User Pages (1-3) allow you to assign eight quick buttons to each page (refer to [User Pages](#)).

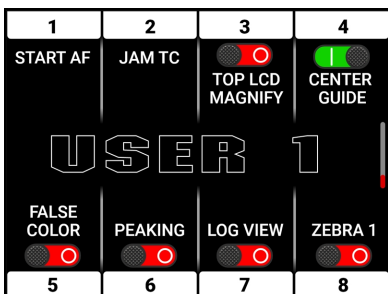

## HOME PAGE

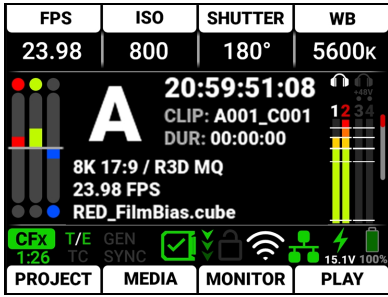

This section describes the Home Page of the LCD GUI. This page contains the Quick Settings, Exposure Meter, Recording Information, VU Meter, Status Bar, and Quick Menu. This is the first page that displays when you power up the camera.

## RECORDING QUICK SETTINGS

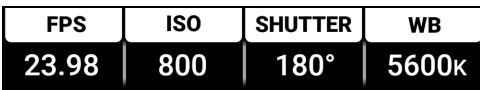

The Recording Quick Settings section of the LCD home page displays the Recording Quick Settings buttons. You can use these buttons to quickly access the most often used camera recording menu settings. These settings include **Recording Frame Rate**, **ISO**, **Shutter**, and **White Balance**.

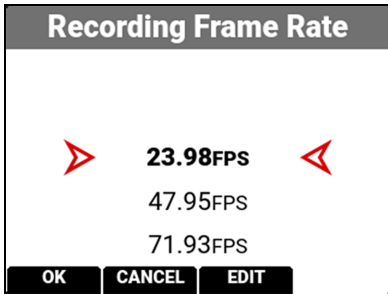

Press the top buttons to open the menu item lists.

Press Up and Down to navigate the list.

Press the button under OK or SEL to select the item and return to the Home Page.

Press the button under CANCEL or press MENU to return to the Home Page without making any changes.

Press and hold the button above SHUTTER to toggle the shutter between degrees and fractions (refer to **Shutter** for more information).

Press and hold White Balance (WB) to toggle between Color Temperature and Color Temperature Presets (refer to **White Balance** for more information).

## RAW RGB EXPOSURE METER

The Exposure section of the LCD home page displays the RAW RGB (pre-ISO) exposure levels for the camera.

### Exposure Meter

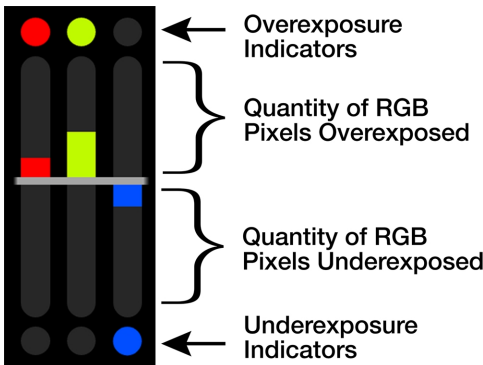

### Overexposed Example

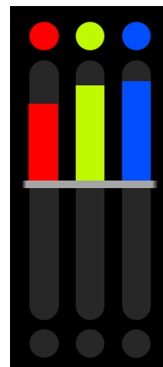

### Underexposed Example

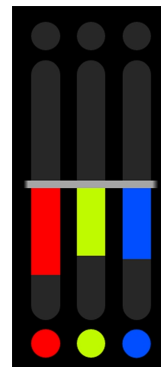

### Balanced Example

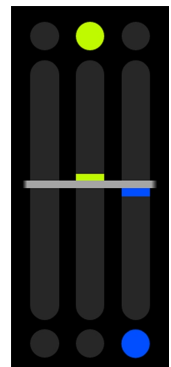

The RAW RGB Exposure Meter displays the quantity of over-exposed or under-exposed pixels in each of the separate red, green, and blue channels of the raw sensor data.

The top and bottom RGB lights illuminate when a small number of pixels on the sensor are overexposed or underexposed. This indicates that a small number of pixels in the image are too bright and will not contain any detail, or are too dark and will appear as noise.

The bars show the quantity of overexposed and underexposed RGB pixels on the sensor. Adjust the settings in the camera such as Iris, or shutter speed to compensate, or change the scene's lighting for the best, balanced image.

## CAMERA DESIGNATION AND REC INDICATOR



The Camera Designation and Record indicator on the LCD home page displays the camera letter assigned to the camera (refer to [Slate](#) and [Camera ID](#)). The color of this area indicates when the camera recording is ready (black), when the camera is recording (red), and when the recording is stopped and the camera is adding the pre-recording (yellow).

Recording:

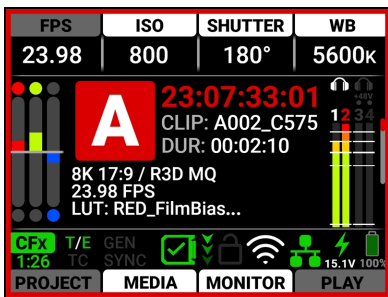

Adding Pre-Recording:

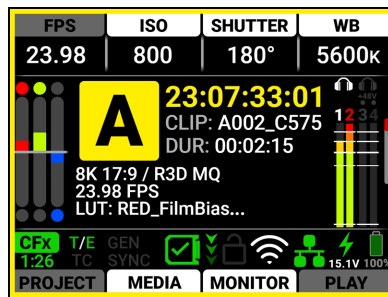

## TIMECODE / EDGECODE

The Timecode / Edgecode section displays the timecode or edgecode (refer to [Timecode Display Mode](#)).

Timecode:

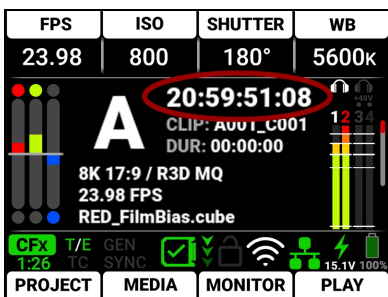

Edgecode:

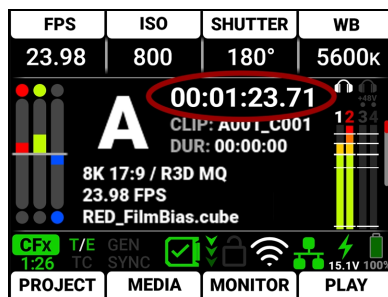

This text turns red when the camera is recording.

## CLIP

The Clip area displays either the currently recording clip name, or the upcoming clip name designated in the Project Settings menu (refer to [Slate](#)).

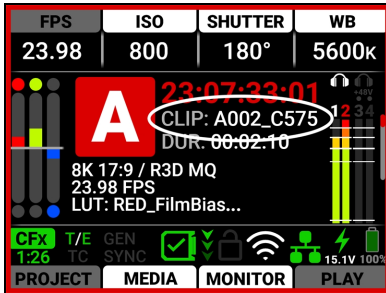

## DURATION

The Duration area displays the real-time duration of the current clip.

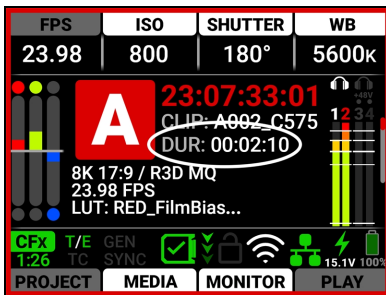

## SENSOR FORMAT

The Sensor Format area displays the sensor format selected in the Project Settings (refer to [Format](#)).

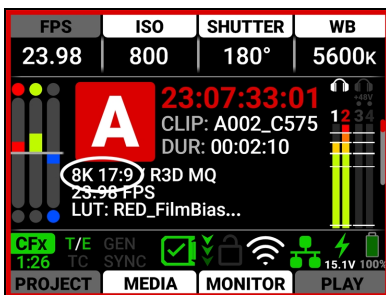

## QUALITY

The Quality area displays the R3D or ProRes compression level (refer to [R3D Quality](#)).

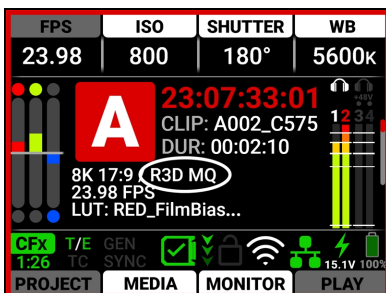



## PROJECT TIME BASE

The Project Time Base area displays the playback rate for the recorded footage selected in the Project Settings (refer to [Project Time Base](#)).

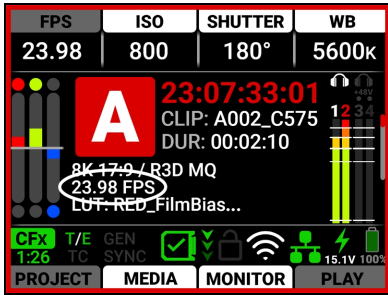

## 3D LUT

The 3D LUT area displays the LUT file selected in the Image / LUT menu (refer to [3D LUT](#)).

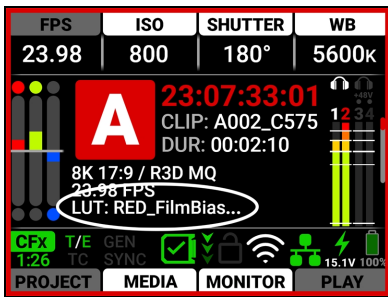

## STATUS BAR



The [Status Bar](#) contains status icons for various camera settings and inputs.

## QUICK MENUS



The Quick Menu section of the LCD home page displays the Quick Menu buttons. Press and hold the button under MEDIA to quickly eject (unmount) the CFexpress media (Refer to [Eject](#) for more information). You can use these buttons to quickly access the most often used camera menus. These settings include [Project Settings Menu](#), [Media Menu](#), [Monitoring Menu](#), and [Playback](#).

| Project Settings            |            |
|-----------------------------|------------|
| <b>Format</b>               | 8K 17:9 >  |
| <b>Recording Frame Rate</b> | 23.98FPS v |
| <b>Project Time Base</b>    | 23.98FPS v |
| <b>File Format</b>          | R3D v      |
| <b>R3D Quality</b>          | MQ v       |

Press the bottom buttons to open the Quick Menus.

Press Up, Down, and SEL to navigate the menus.

Press MENU to return to the Home screen.

## PLAYBACK

When you press the button below PLAY on the Home Page, the LCD displays the Playback screen.



To close the Playback screen, press the button below CAMERA.

## PLAYBACK SCREEN



The Playback screen displays the following:

- [Clip Information](#)
- [Playback Screen Buttons](#)

## CLIP INFORMATION



The Clip Information displays the name, Timecode, duration, project time base, format, and timeline of the clip.

## PLAYBACK SCREEN BUTTONS



With the Playback screen buttons you can view the Clip list, move to the start of the clip, fast reverse, play/pause, fast forward, and move forward and reverse by a single frame.

## CLIP LIST



Press the button over the Clip List to open the Clip Load list.

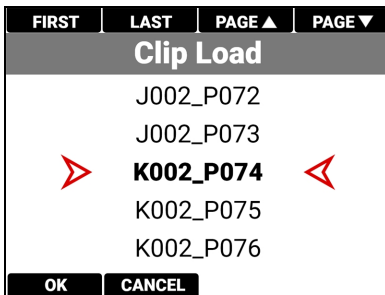

Navigate to the desired clip and press the button under OK to open the clip in the Playback screen.

## START/END



Press the button above the Start or End button to navigate to the start or end of the clip.

## NEXT PREVIOUS



Press the UP arrow to move forward by a single frame and press the DOWN arrow to reverse by a single frame.

## REWIND



Press the button below Rewind to quickly navigate backwards through the clip.

## PLAY/PAUSE



Press the button below Play/Pause to toggle between playing the clip and pausing the clip.

## FAST FORWARD



Press the button below Fast Forward to quickly navigate forward through the clip.

## CAMERA



Press the button below CAMERA to return to the camera interface.

## HISTOGRAM PAGE

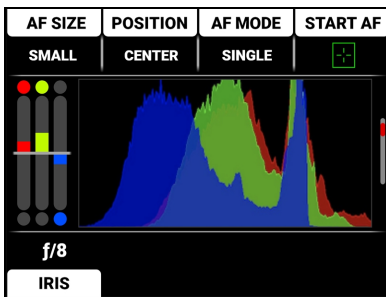

The LCD Histogram page is the second page on the LCD. Press the down button to navigate from the Home page to the Histogram page.

The Histogram Page contains the Autofocus Quick Settings, Exposure Meter, Histogram, and Iris/ND Quick Settings.

## AUTOFOCUS QUICK SETTINGS



The Autofocus quick settings allow you to access the Autofocus settings quickly.

- Press the button above AF SIZE to select the autofocus size

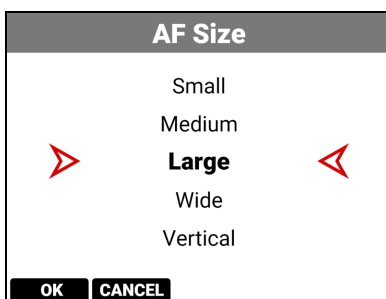

- Press the button above POSITION to select the autofocus location on the screen

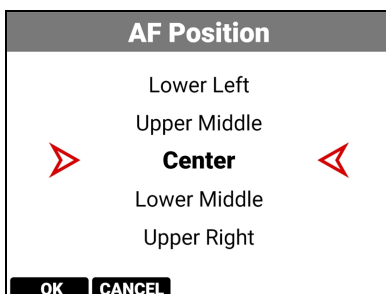

- Press the button above AF MODE to select the autofocus mode

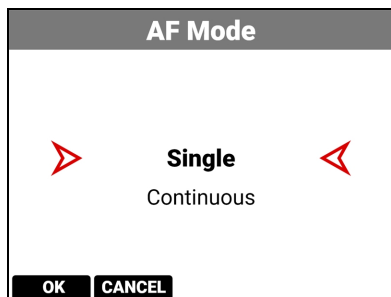

- Press the button above START AF to enable autofocus
- Refer to [Autofocus Menu](#) for more information about the Autofocus menu.

## RAW RGB EXPOSURE METER

The Exposure meter displays the RAW RGB (pre-ISO) exposure levels for the camera.

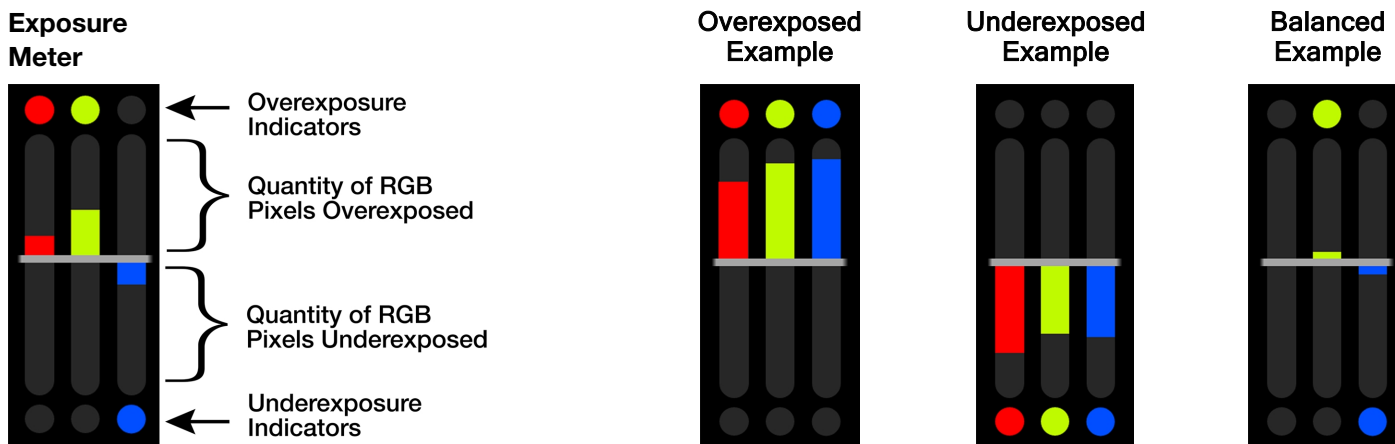

The RAW RGB Exposure Meter displays the quantity of over-exposed or under-exposed pixels in each of the separate red, green, and blue channels of the raw sensor data.

The top and bottom RGB lights illuminate when a small number of pixels on the sensor are overexposed or underexposed. This indicates that a small number of pixels in the image are too bright and will not contain any detail, or are too dark and will appear as noise.

The bars show the quantity of overexposed and underexposed RGB pixels on the sensor. Adjust the settings in the camera such as Iris, or shutter speed to compensate, or change the scene's lighting for the best, balanced, image.

## HISTOGRAM

The Histogram area displays a histogram distribution of the RGB exposure of the Log3G10 signal after ISO and White Balance adjustments.

The histogram displays the darkest image elements at the far left, the midtones in the middle, and the lightest image elements at the far right. This gives you a fast way to determine your overall image exposure levels.

### Overexposed Example

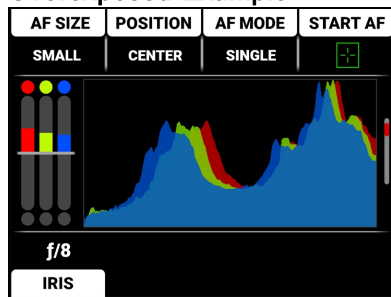

### Underexposed Example

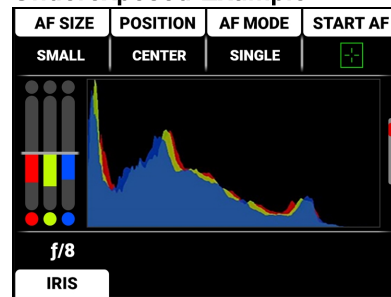

## IRIS QUICK SETTINGS



The Iris and ND quick settings allow you to access the Iris and ND settings quickly.

Press the button under IRIS to open the Iris menu list and select the lens f-stop.

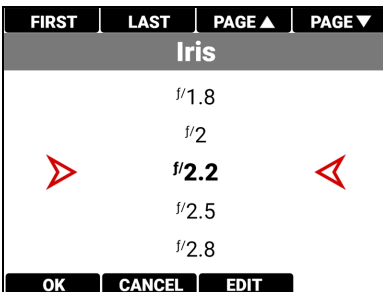

Refer to [Lens](#) for more information about the Iris settings.

## TOOLS PAGE

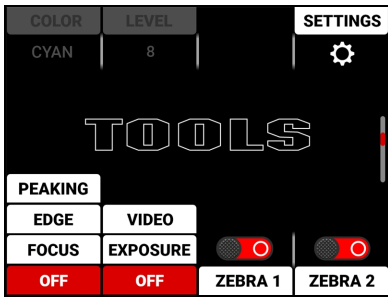

The LCD Tools page is the third page on the LCD. Press the down button twice to navigate from the Home page to the Tools page.

The Tools Page contains the Peaking Modes, False Color Modes, Zebra Tool Switches, and Quick Monitor Menu.

## PEAKING MODES

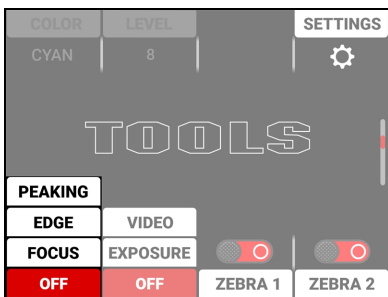

The Peaking tools are modes that provide different ways to indicate image focus. The Peaking modes you can select include:

| ITEM    | DETAILS   |
|---------|---|
| Peaking | Select a colored overlay to indicate objects in focus |
| Edge    | Show outlines of focused objects                      |
| Focus   | Use enhanced contrast and edges for focusing          |

Press the button below the Peaking tools column to cycle through the choices. When you select the Peaking tool Peaking mode, the settings for Color and Level are enabled:

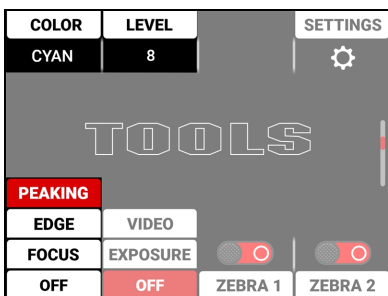

For more information refer to [Peaking](#).

## FALSE COLOR MODES

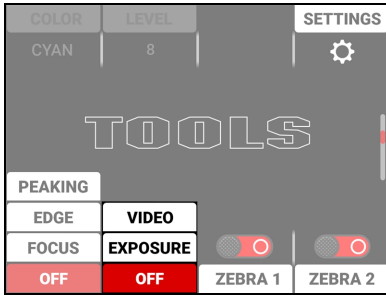

Press the button below the False Color tools column to cycle through the choices.

False Color Modes include:

| ITEM                      | DETAILS   |
|---------------------------|---|
| False Color Video Mode    | Display an overlay that indicates exposure levels without relying on inaccurate LCD image brightness. |
| False Color Exposure Mode | Use false colors to determine an optimal balance between overexposure and underexposure.              |

**NOTE:** False Color modes display on video recorded through SDI to an external recorder when the Tools are enabled in the Monitor menu. When recording through SDI, use False Color modes only to help determine scene exposure settings, and then disable the mode before recording.

## FALSE COLOR VIDEO MODE

**NOTE:** For best results, Video Mode should be viewed at or above ISO 800.

Video Mode displays a color overlay that indicates the video level of the RGB monitor path (calibrated to the SMPTE test signal).

The colors used are based on the RGB levels of the video out signal (that is, the “cooked” look, and not RAW data). The camera’s RGB settings can change the appearance of the Video Mode colors.

For more information, refer to [False Color](#).

## FALSE COLOR EXPOSURE MODE

When this monitoring False Color mode is activated, most of the tonal range will appear in monochrome.

The Exposure Mode is able to indicate exactly where middle gray is falling, and indicate which highlights or shadows are problematic in the logarithmic representation of the image. Exposure mode is judging the exposure after ISO and White Balance adjustments are made, and before any sort of LUT or transform is applied to the Log3G10 image.

For more information, refer to [False Color](#).

## ZEBRA TOOLS

Use Zebra 1 to display one set of diagonal stripes to indicate highlight exposure levels. Use Zebra 2 to display a second set of diagonal stripes to indicate mid-tone and shadow levels. For more information, refer to [Zebra Modes](#).



## ZEBRA 1

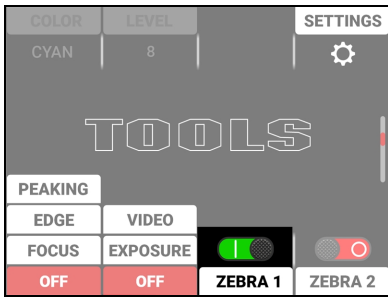

Press the button below the ZEBRA 1 switch to enable or disable the Zebra 1 tool.

For more information, refer to [Zebra 1](#).

## ZEBRA 2

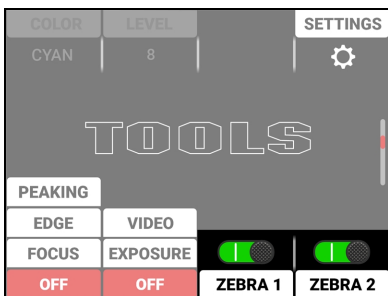

Press the button below the ZEBRA 2 switch to enable or disable the Zebra 2 tool.

For more information, refer to [Zebra 2](#).

## QUICK MONITOR MENU

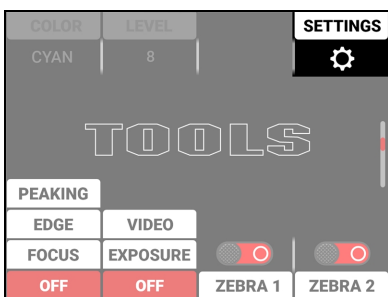

Press the button above SETTINGS to open the Quick Monitoring Menu.

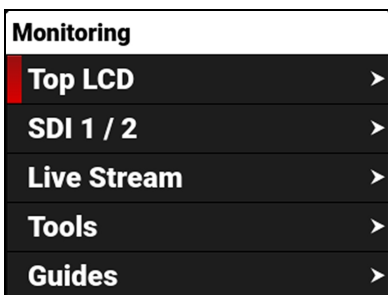

For more information, refer to [Monitoring Menu](#).

## SDI PAGE

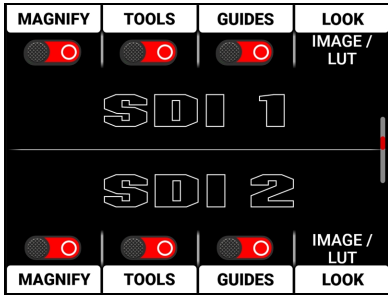

The SDI Page contains the switches you use to enable or disable the SDI features, and the Look settings for SDI Port 1 and SDI Port 2.

## SWITCHES

The SDI 1 and SDI 2 sections contain the switches you can use to enable and disable image magnification, focus and exposure tools, and frame and center guides. For more information, refer to the [Monitoring Menu](#) section.

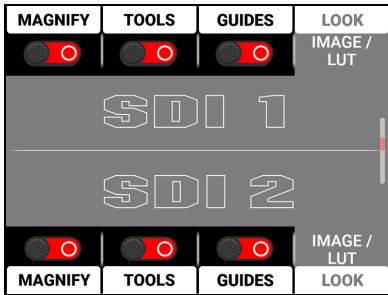

Press the button next to the switch to toggle from disabled to enabled.

Select LOOK to open the Look options for the SDI 1 and SDI 2 ports.

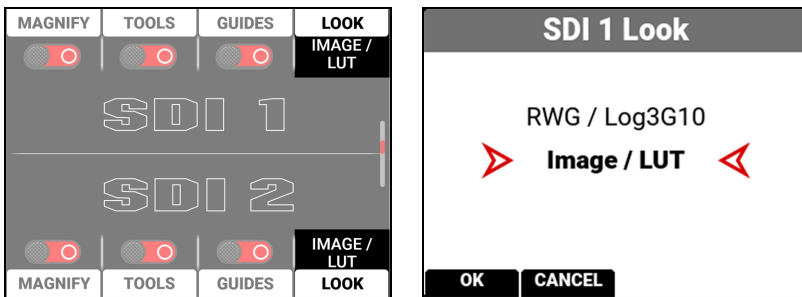

You can select the Image / LUT look defined in the Image / LUT menu, or you can select the RWG (REDWideGamutRGB) / Log3G10 Image Processing Pipeline (IPP2) look.

## AUDIO CHANNELS 1 / 2 PAGE

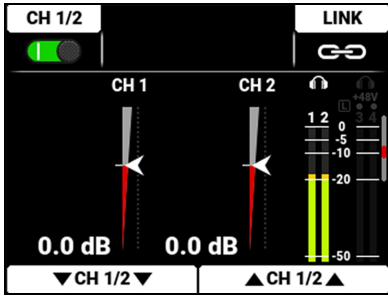

Press the down button to navigate from the Home page to the Audio Channels 1 / 2 page.

The Audio Channels 1 / 2 page contains the switch to enable the internal microphone channels (1 and 2), a button to enable and disable the link between the channel 1 and 2 levels, the audio level indicators, the headphone monitoring indicator, the 48-volt phantom power indicator, the audio VU meters for channels 1, 2, 3, and 4, adjusters to reduce the audio channel 1 and 2 levels, and adjusters to increase the audio channel 1 and 2 levels.

## TOP BAR



The Audio Channels 1 / 2 top bar allows you to enable the internal microphones (channels 1 and 2).

- Press the button above CH 1/2 to enable or disable the internal microphones
- Press the button above LINK to link the audio level adjustments for channels 1 and 2

Refer to the [Audio / TC Menu](#) section for more information about the audio features.

## LEVEL INDICATORS

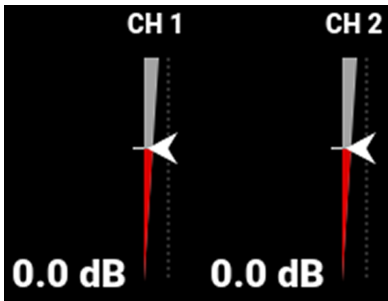

The audio level indicators move up and down to indicate the changes in the audio level adjustments. The level measured in decibels is displayed below the level indicators. You can adjust channels 1 and 2 individually, or you can link the channels and adjust them together.

## VU METER

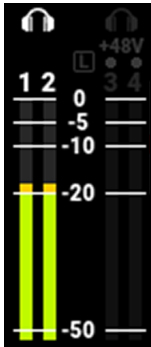

The VU meter displays the headphone indicators, the limiter indicator, the 48 V phantom power indicator, the audio channel numbers, and the audio signal levels.

## BOTTOM BAR



The Audio Channels 1 / 2 bottom bar allows you to adjust the internal microphones (channels 1 and 2). You can adjust the channels individually or you can link them and adjust them together.

- Press the buttons below CH1 ▼ to reduce the external audio levels (channel 1)
- Press the buttons below CH1 ▲ to increase the external audio levels (channel 1)
- Press the buttons below CH 2 ▼ to reduce the external audio levels (channel 2)
- Press the buttons below CH 2 ▲ to increase the external audio levels (channel 2)

Refer to the [Audio / TC Menu](#) section for more information about the audio features.

## AUDIO CHANNELS 3 / 4 PAGE

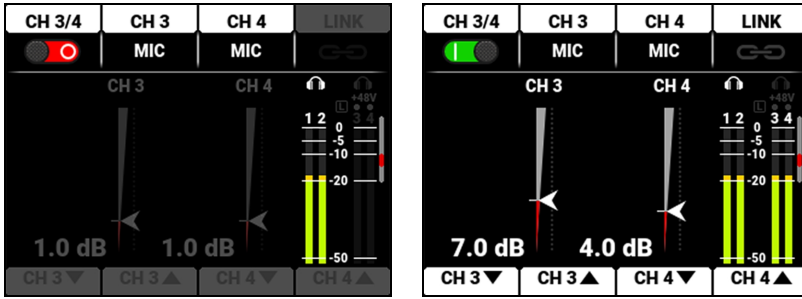

Press the down button to navigate from the Home page to the Audio Channels 3 and 4 page.

The Audio Channels 3 and 4 page contains a switch to enable the external audio input channels (3 and 4), a button to enable and disable the link between the channel 3 and 4 levels, the audio level indicators, the headphone monitoring indicator, the 48-volt phantom power indicator, the audio VU meters for channels 1, 2, 3, and 4, adjusters to reduce the audio channel 3 and 4 levels, and adjusters to increase the audio channel 3 and 4 levels.

## TOP BAR



The Audio Channels 3 and 4 top bar allows you to enable the external audio inputs (channels 3 and 4).

- Press the button above CH 3/4 to enable or disable the external audio
- Press the button above CH 3 or CH 4 to open a list of external audio options for those channels (Mic, Line, +48V)

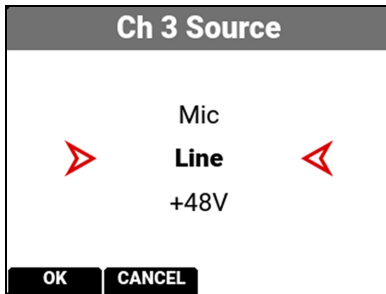

- Press the button above LINK to link the audio level adjustments for channels 3 and 4

Refer to the [Audio / TC Menu](#) section for more information about the audio features.

## LEVEL INDICATORS

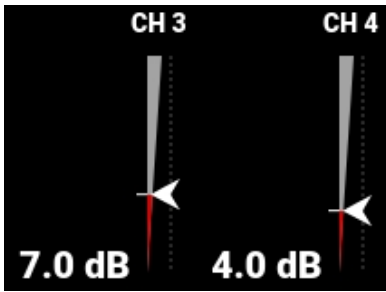

The audio level indicators move up and down to indicate the changes in the audio level adjustments. The level measured in decibels is displayed below the level indicators. You can adjust channels 3 and 4 individually, or you can link the channels and adjust them together.

## VU METER

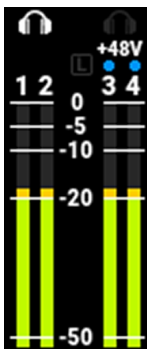

The VU meter displays the headphone indicators, the limiter indicator, the +48 V phantom power indicator, the audio channel numbers, and the audio signal levels.

## BOTTOM BAR



The Audio Channels 3 and 4 bottom bar allows you to adjust the external audio (channels 3 and 4) in 3 dB increments. You can adjust the channels individually or you can link them and adjust them together.

- Press the buttons below CH 3▼ to reduce the external audio levels (channel 3)
- Press the buttons below CH 3▲ to increase the external audio levels (channel 3)
- Press the buttons below CH 4▼ to reduce the external audio levels (channel 4)
- Press the buttons below CH 4▲ to increase the external audio levels (channel 4)

Refer to the [Audio / TC Menu](#) section for more information about the audio features.

## HEADPHONE PAGE

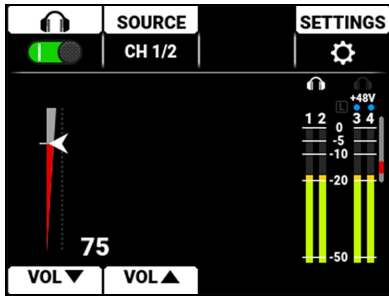

Press the down button to navigate from the Home page to the Headphone page.

The Headphone page contains the switch to enable the headphone jack, a source list to select the source to monitor (CH 1/2 or CH 3/4), the headphone level indicator, the headphone monitoring indicator, the limiter indicator, the +48 volt phantom power indicator, the audio VU meters for channels 1, 2, 3, and 4, an adjuster to reduce the headphone levels, and an adjuster to increase the headphone levels.

## TOP BAR



The Headphone top bar allows you to enable/disable the headphone port output, to select the source of the headphone output (internal channels 1 and 2 or external channels 3 and 4), and to quickly access the Audio /TC menu.

- Press the button above the headphone icon to enable or disable the headphone audio
- Press the button above SOURCE to open the list of channels to monitor (Ch 1/2 or Ch 3/4)

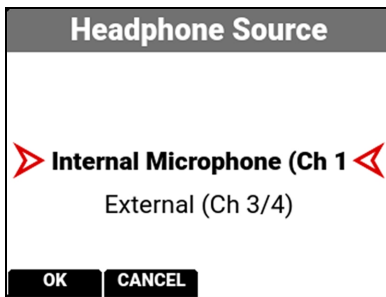

- Press the button above SETTINGS to open the Audio / TC menu

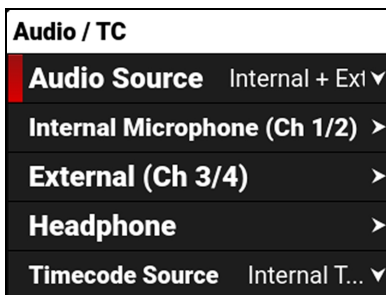

Refer to the [Audio / TC Menu](#) section for more information about the audio features.

## LEVEL INDICATOR

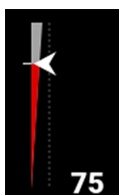

The audio level indicator moves up and down to indicate the changes in the headphone level adjustments. The level measured in decibels is displayed below the level indicator.

## VU METER

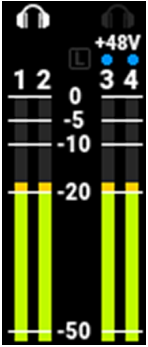

The VU meter displays the headphone indicators, the limiter indicator, the +48 V phantom power indicator, the audio channel numbers, and the audio signal levels.

## BOTTOM BAR



The headphone bottom bar allows you to adjust the headphone volume.

- Press the button below VOL ▼ to reduce the headphone volume
- Press the button below VOL ▲ to increase the headphone volume

Refer to the [Audio / TC Menu](#) section for more information about the headphone features.

## SENSOR SYNC SHIFT PAGE

Use the Sync Shift page to quickly offset the sensors synchronization from the incoming Genlock source. This allows you to fine-tune synchronization issues in production environments such as shooting with LED Volumes.

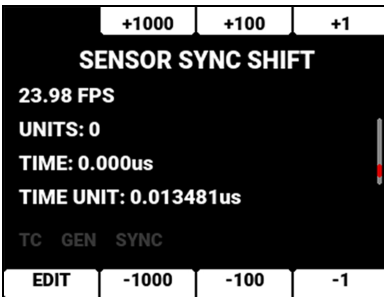

The Sensor Sync Shift page buttons allow you to quickly adjust the sensor sync shift in units of 0.013481 microseconds.

## USER PAGES

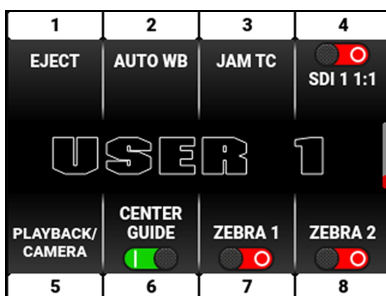

The User (1, 2, 3) pages are the last pages on the LCD. Press the up button to navigate from the Home page to the User pages.

The User Pages contain the settings you assigned to the pages in the User Settings menu. From this page you can press buttons next to 1-8 to quickly select a camera setting or feature.

Refer to the [User Settings Menu](#) section for more information.















## STATUS BAR

The LCD screen displays the camera status bar.



The Status Bar contains the following button and icons:

-  CFexpress Status Icon
-  Temperature / Exposure Icon
-  Timecode Icon
-  Genlock Icon
-  SYNC Icon
-  Camera Status Icon
-  Network Activity Icon
-  Wi-Fi Icon
-  Network Icon
-  LCD Lock Icon
-  Battery Icon
-  DC-In Icon

### CFEXPRESS STATUS ICON



This icon displays the status of the CFexpress media card, and it displays the recording time remaining for the current camera settings.

The status displayed includes:



Good



Missing



Incompatible

### TEMPERATURE / EXPOSURE ICON



This icon displays the temperature (T) and exposure (E) calibration indicators.

- When T is yellow or red, it indicates that the camera requires sensor re-calibration at the current ambient temperature.
- When E is yellow or red, it indicates that the camera requires sensor re-calibration at the current shutter speed or sensor scan orientation.

Refer to [Calibrating the Sensor](#).

## TIMECODE ICON



This icon indicates the state of the Timecode generator connection.



Gray indicates that no Timecode generator signal is detected.



Green indicates that the Timecode source is connected and jammed.



Red indicates that the selected Timecode Source is not present, or not jammed in the last 12 hours.



White indicates that the selected Timecode source is not currently connected but was jammed during the current camera boot.



Yellow indicates that the selected Timecode source has not been jammed in current camera boot but has been within the last 12 hours, or that timecode source is cross-jammed (at a different **Project Time Base**).

## GENLOCK ICON



This icon indicates the state of the Genlock connection.



Gray indicates that no Genlock signal is detected.



Green indicates that the camera is receiving and is locked to a Genlock signal.



Red indicates that the camera is receiving and is not locked to a Genlock signal.

## SYNC ICON



This icon indicates that the Timecode and Genlock signals are synchronized to the camera's frames per second (FPS) settings.



Gray indicates that no synchronization is detected.



Green indicates that the camera is synchronized with the Timecode and Genlock signals.



Yellow indicates that the camera is synchronized using Genlock but not Timecode.

## CAMERA STATUS ICON



This icon indicates the state of the camera hardware. The different icons and their corresponding status include:



Good: Camera operating as expected.



Overheating Warning: Camera is nearing overheated state. Consider cooling the camera.



Overheating: Camera has reached temperature threshold and shut down is imminent.



Shutting Down: Camera is shutting down due to overheating.

---

## NETWORK ACTIVITY ICON

---



This icon indicates the state of FTPS or Cloud data transfer.



Gray indicates that no network data transfer is occurring.



Green indicates that the camera is transferring FTPS or Cloud data.

---

## WI-FI ICON

---



This icon indicates the state of Wi-Fi connection.



Gray and empty indicates that no Wi-Fi signal is detected.



White bars indicate that Wi-Fi signal is detected (Infrastructure).



White antenna indicates that Wi-Fi signal is broadcasting (Ad-hoc).

---

## NETWORK ICON

---



This icon indicates the state of the network connection.



Gray indicates that the camera is not connected to a network.



Green indicates that the camera is connected to a network.

---

## LCD LOCK ICON

---



This icon indicates the state of the LCD Lock. The states include:



Gray and open indicates that the camera LCD is unlocked.



White and closed indicates that the camera LCD is locked.

---

## BATTERY ICON



This icon indicates the state of the battery connection and charge level. When the voltage is low, it displays the voltage in red.



Gray indicates that no battery is connected.



White indicates that the battery is connected and green shows the relative level of charge remaining.



Yellow indicates 10 minutes of power remaining.



Red indicates less than 5 minutes of power remaining.



Gray question mark indicates no communication with the battery and no power.



White question mark indicates no communication with the battery and power.



Gray exclamation point indicates error communicating with the battery and no power.

---

## DC-IN ICON



This icon indicates the state of DC power connection.



Gray with gray NA indicates that no DC power is connected.



Green with white voltage numbers indicates that the camera is receiving DC power.



Green with flashing red voltage numbers indicates low DC power. The low power warning gasholder is defined in the System Settings>Power menu.

## RED CONTROL APP

The RED Control app provides remote and tethered access to the camera from a device. Access is available through Wi-Fi, USB-C, USB-C to Ethernet, or GIG-E.

The RED Control app is free through the Google Play store and the Apple App store.

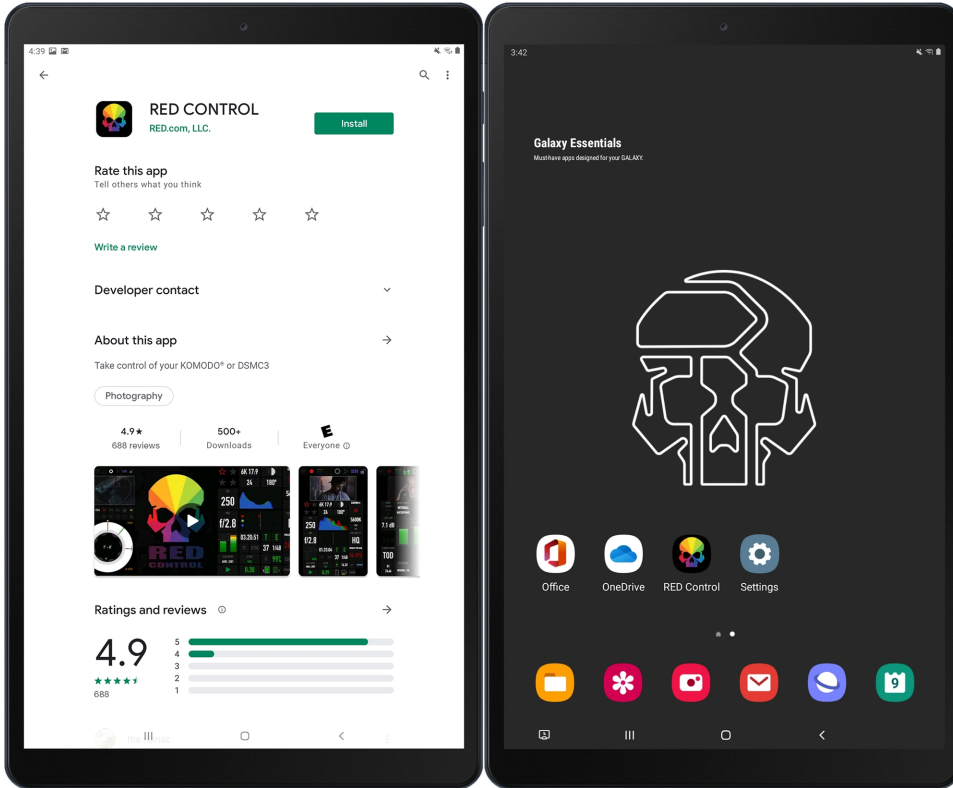

The RED Control app allows you to control all of the camera features while viewing the image.

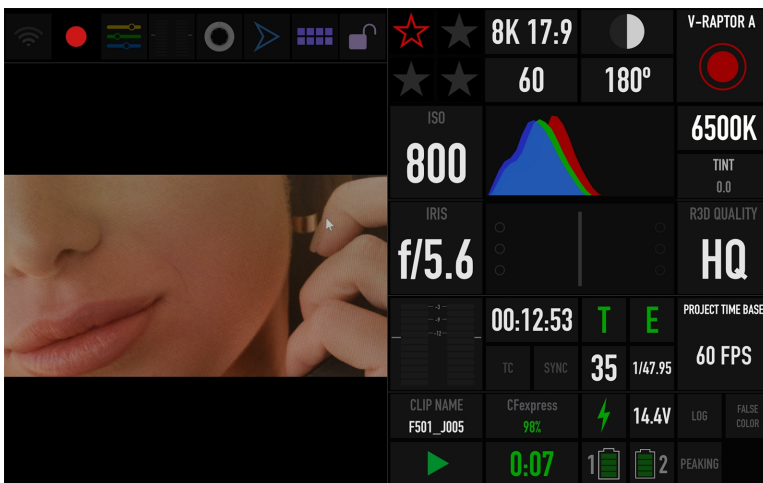

For more information about connecting the camera to RED Control, refer to the How-To section ([USB-C Configuration](#)).

## RED CONTROL PRO

You can use the RED Control Pro App for advanced control over the V-RAPTOR™, and for multi-camera arrays. RED Control Pro offers advanced features and an enhanced experience, including native iPad and Mac support, multi-camera control, quick settings overview, FTP file access, advanced LUT, CDL and PRESET management, and independent image orientation settings. RED Control Pro is also fully redesigned for larger screens and monitoring of live streaming from several cameras simultaneously. The MacOS version includes additional features such as, clip auto download, and detachable and resizable windows.

### NOTES:

- The RED Control Pro App is compatible with V-RAPTOR, V-RAPTOR XL, and KOMODO 6K only. It is not available for use with DSMC2 or previous generation RED cameras.
- Lens control requires a compatible electronic lens. Multi-camera control requires that all devices are connected to the same local network.



## 4. MENUS

This section describes the menus and sub-menus for the camera. To access the menus, navigate to a menu item from the LCD.

| MENUS                 | DETAILS  |
|-----------------------|--|
| Image / LUT Menu      | ISO, Shutter, White Balance, Output Color Space, Output Tone Map, Highlight Roll-Off, Display Preset, 3D LUT, CDL, Exposure Adjust   |
| Project Settings Menu | Format, Recording Frame Rate, Project Time Base, File Format, R3D Quality, ProRes Proxy Record, ProRes Resolution, ProRes Codec, ProRes Color Profile, Pre-Record, Recording Mode, Timelapse, Frame Limit, Slate |
| Audio / TC Menu       | Audio Source, Internal Microphone, External, Headphone, Timecode Source, Jam Timecode to TOD, Timecode Display Mode  |
| Monitoring Menu       | Top LCD, SDI 1/2, Live Stream, Tools, Guides   |
| Media Menu            | Eject, Media Info, Secure Format   |
| User Settings Menu    | Presets, Side LCD, User 1, User 2, User 3, User Buttons  |
| Autofocus Menu        | Enable, Mode, Size, Position, Start AF   |
| Communication Menu    | Camera, Connections (USB-C, Wi-Fi, Serial), Clients & Services (FTPS, PTP), Cloud Upload (Frame.io, AWS S3)  |
| System Settings Menu  | Date / Time, Lens, Power, Sensor, Side LCD Brightness, Indicators, GPO Function, Status Settings, System Status  |
| Language Menu         | English, Chinese, French, German, Japanese, Spanish  |
| Maintenance Menu      | Calibrate, Calibration, Save Log, Reset Defaults, Factory Reset, Upgrade   |

| MENUS                 | DETAILS  |
|-----------------------|--|
| Image / LUT Menu      | ISO, Shutter, White Balance, ND Enable, ND, Output Color Space, Output Tone Map, Highlight Roll-Off, Display Preset, 3D LUT, CDL, Exposure Adjust  |
| Project Settings Menu | Format, Recording Frame Rate, Project Time Base, File Format, R3D Quality, ProRes Proxy Record, ProRes Resolution, ProRes Codec, ProRes Color Profile, Pre-Record, Recording Mode, Timelapse, Frame Limit, Slate |
| Audio / TC Menu       | Audio Source, Internal Microphone, External, Headphone, Timecode Source, Ambient Module Settings, Auto Jam, Jam Timecode to TOD, Manual Timecode, Timecode Display Mode  |
| Monitoring Menu       | Top LCD / EVF SDI, SDI 1/2/3, Live Stream, Tools, Guides   |
| Media Menu            | Eject, Media Info, Secure Format   |
| User Settings Menu    | Presets, Side LCD Control Panels, User 1, User 2, User 3, User Buttons   |
| Autofocus Menu        | Enable, Mode, Size, Position, Start AF   |
| Communication Menu    | Camera, Connections (USB-C, Wi-Fi, GIG-E, Serial), Clients & Services (FTPS, PTP), Cloud Upload (Frame.io, AWS S3)   |
| System Settings Menu  | Date / Time, Lens, Fan Control, Power, Sensor, Side LCD Brightness, Indicators, GPO Function, Status Settings, System Status   |
| Language Menu         | English, Simplified Chinese, French, German, Japanese, Spanish   |
| Maintenance Menu      | Calibrate, Calibration, Save Log, Reset Defaults, Factory Reset, Upgrade   |

## IMAGE / LUT MENU

The Image / LUT menu contains the settings you use to configure your image.

From the camera LCD menu, navigate to Image / LUT and press SEL:

| Menu                    |   | Menu > Image / LUT        |              |
|-------------------------|---|---------------------------|--------------|
| <b>Image / LUT</b>      | > | <b>ISO</b>                | ISO800 ▼     |
| <b>Project Settings</b> | > | <b>Shutter</b>            | 180° ▼       |
| <b>Audio / TC</b>       | > | <b>White Balance</b>      | >            |
| <b>Monitoring</b>       | > | <b>Output Color Space</b> | Rec. 709 ▼   |
| <b>Media</b>            | > | <b>Output Tone Map</b>    | Medium ... ▼ |

Use the Image / LUT menu to configure the camera's image and lookup table (LUT) settings:

| ITEM               | DETAILS   |
|--------------------|---|
| ISO                | Adjusts the image's brightness in the monitoring path             |
| Shutter            | Adjusts the amount of light exposed to the sensor                 |
| White Balance      | Adjusts the colors to compensate for the light source temperature |
| Output Color Space | Adjusts on-set working color space                                |
| Output Tone Map    | Adjusts the image contrast  |
| Highlight Roll-Off | Adjusts image highlight compression                               |
| Display Preset     | Select the displayed preview image gamma for the SDI ports        |
| 3D LUT             | Manage the camera's look up tables (LUTs)                         |
| CDL                | Opens the Color Decision List (CDL) menu                          |
| Exposure Adjust    | Manually fine-tunes the midtone exposure level                    |



## ISO

Use the ISO setting to adjust the image's brightness in the monitoring path.

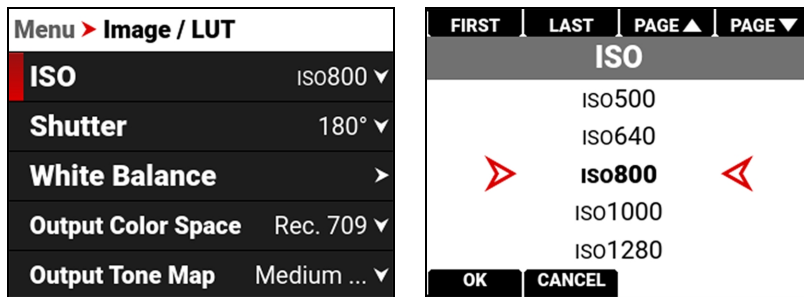

The ISO range is ISO 250 to ISO 12,800. The default ISO is ISO 800.

Higher ISO values create brighter images in the monitor path, and lower ISO values create darker images in the monitor path.

When you record, the ISO settings are stored as metadata and you can adjust them non-destructively in post-processing with REDCINE-X PRO or other editing tools that support R3D files.

RED recommends setting the ISO to the default of 800, then adjusting the aperture and lighting to match. You can adjust the ISO later for fine-tuning.

## SHUTTER

Use Shutter to select the exposure time (shutter speed / shutter angle). The camera allows you to change the shutter settings while recording.

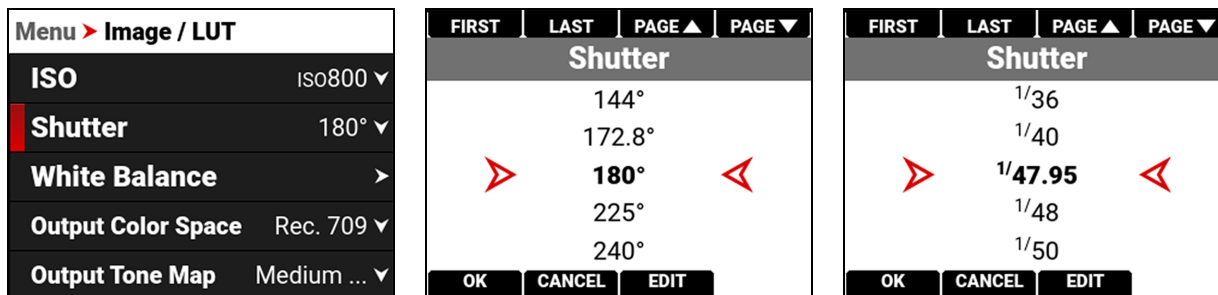

You can switch between angle and time by using the [Status Settings](#) or by pressing and holding the button above SHUTTER on the Home Page (refer to [Home Page](#)).

Decreasing shutter speed increases the amount of time that light hits the sensor, which increases exposure and motion blur of moving objects. Increasing shutter speed decreases the amount of time that light hits the sensor, which decreases exposure and motion blur of moving objects.

## SHUTTER ANGLE

Enter the exposure value as a shutter angle (xx°). The shutter angle range is 1° to 360°. The default shutter angle is 180°. Click Edit to enter an exact shutter angle or shutter speed.

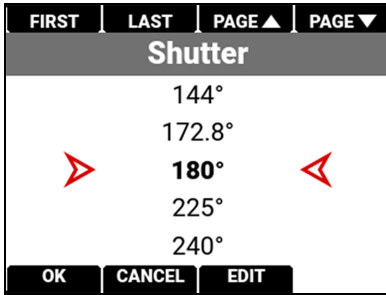

## EXPOSURE CONVERSIONS

The table below lists common shutter angle and shutter speed equivalents. The calculations in the table use a recording frame rate of 23.98 fps.

| SHUTTER ANGLE (°) | SHUTTER SPEED (1/XX SEC) | SHUTTER ANGLE (°) | SHUTTER SPEED (1/XX SEC) |
|-------------------|--------------------------|-------------------|--------------------------|
| 360°              | 1/23.98                  | 105°              | 1/82.20                  |
| 288°              | 1/29.97                  | 90°               | 1/95.90                  |
| 270°              | 1/31.97                  | 72°               | 1/119.88                 |
| 240°              | 1/35.96                  | 45°               | 1/191.81                 |
| 225°              | 1/38.36                  | 22.5°             | 1/383.62                 |
| 180°              | 1/47.95                  | 11.2°             | 1/770.66                 |
| 172.8°            | 1/49.95                  | 8.6°              | 1/1003.65                |
| 144°              | 1/59.94                  | 4°                | 1/2157.84                |
| 135°              | 1/63.95                  | 1°                | 1/8000 (max)             |
| 120°              | 1/71.93                  |                   |                          |

## SHUTTER SPEED

Enter the exposure value as a shutter speed (1/xx sec).

The slowest shutter speed is 1/(recording frame rate). For example, if the recording frame rate is 23.98 fps, the slowest available shutter speed is 1/23.98 sec. The fastest shutter speed is 1/8000 sec. The default shutter speed is 1/47.95 sec.

### CONVERT SHUTTER SPEED TO SHUTTER ANGLE

Shutter Angle = (Shutter Speed x Frame Rate x 360)

Example:  $(1/47.95 \times 23.98 \times 360) = 180$

### CONVERT SHUTTER ANGLE TO SHUTTER SPEED

Shutter Speed =  $1/(\text{Frame Rate} \times 360/\text{Angle})$

Example:  $1/(23.98 \times 360/180) = 1/47.95$

## WHITE BALANCE

Use the White Balance menu to adjust the **Color Temperature** and the **Tint**.

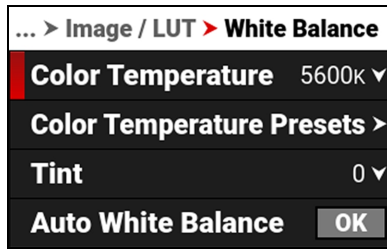
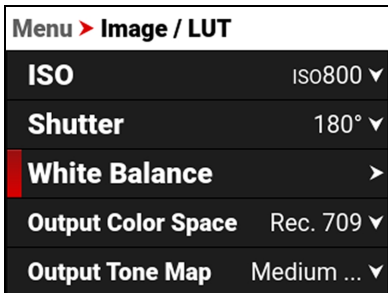

When shooting in R3D format, the camera stores white balance as metadata, which you can adjust non-destructively in post-production after filming.

Use the White Balance menu to configure the color temperature and tint settings for your image:

| ITEM                             | DETAILS  |
|----------------------------------|--|
| <b>Color Temperature</b>         | Image color temperature correction                           |
| <b>Color Temperature Presets</b> | Select a preset color temperature                            |
| <b>Tint</b>                      | Adjust magenta-green color component                         |
| <b>Auto White Balance</b>        | The camera automatically sets the color temperature and tint |

## COLOR TEMPERATURE

Use Color Temperature to adjust the image's color temperature in Kelvin units (K) or by selecting presets.

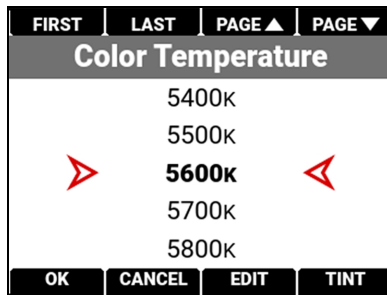
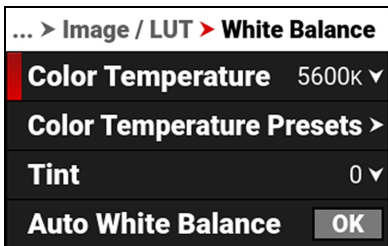

When the image's light source color temperature is warm, you can compensate by setting the camera to a warmer color temperature. When the image's light source color temperature is cool, you can compensate by setting the camera to a cooler temperature.

The color temperature range is 1,700 K to 10,000 K. The default color temperature is 5600 K.

When the White Balance List Mode (refer to **Status Settings**) is set to Presets, the Color Temperature menu list uses the Preset temperatures instead of the Kelvin temperatures.

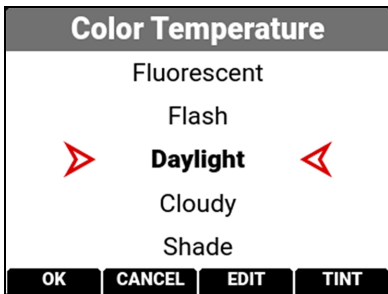

## COLOR TEMPERATURE PRESETS

Use Color Temperature Presets to select a pre-configured color temperature.

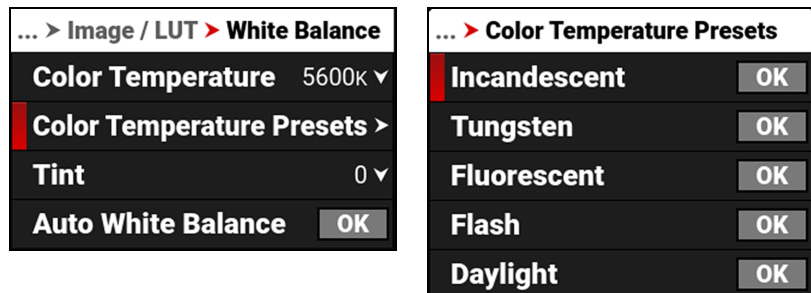

The color temperature presets you can select include:

| ITEM         | DETAILS | ITEM     | DETAILS |
|--------------|---------|----------|---------|
| Incandescent | 2800 K  | Daylight | 5600 K  |
| Tungsten     | 3200 K  | Cloudy   | 7500 K  |
| Fluorescent  | 4500 K  | Shade    | 9000 K  |
| Flash        | 5500 K  |          |         |

## TINT

Use Tint to adjust the image's color tint.

Color temperature calculations assume a pure light source that may not be true in the specific scene the camera is imaging. To compensate for any residual colorcast, the Tint setting adjusts the RGB color balance with a compensating magenta-green color component.

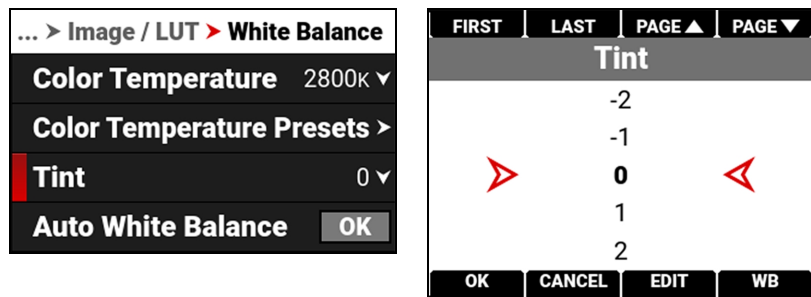

Tint range is -100 to 100. The default Tint setting is 0.

## AUTO WHITE BALANCE

Use Auto White Balance to use the camera's automatic white balance adjustment.

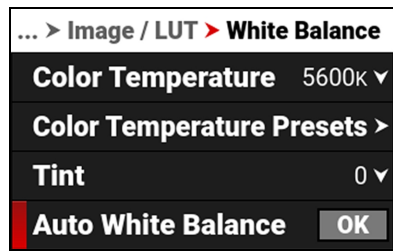

When shooting in R3D format, the camera stores white balance as metadata, which you can adjust non-destructively in post-production after filming.

To use Auto White Balance:

1. Place an 18% gray chart in the center of the image under the correct exposure.
2. From the **White Balance** menu, navigate down to **Auto White Balance** and press SEL to enable.
3. The camera automatically sets the color temperature and tint settings.

**NOTE:** Place the chart in the same location as your subject, and illuminate it with the same lighting. Make sure that you center the chart, and that it fills at least 25% of the sensor area.

## OUTPUT COLOR SPACE

Use Output Color Space to select the desired color space associated with the clip. When the camera file format is R3D, it saves this color space as metadata, which you can adjust in post-processing. When the camera file format is ProRes, and the ProRes Color Profile is Image/LUT, the camera bakes the color space in the resulting image.

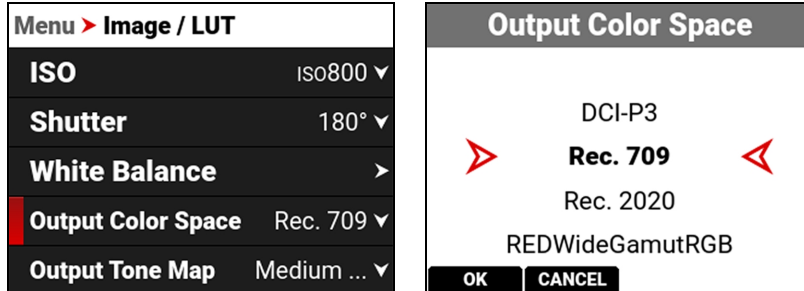

The Output Color Space selections include:

- DCI-P3 - Digital Cinema Initiatives theater projector standard color space
- Rec. 709 - Standard Color Space for HDTV (default)
- Rec. 2020 - Standard Color Space for UHD and HDR
- REDWideGamutRGB - Color space encompassing all of the colors that the RED camera can generate without clipping

## OUTPUT TONE MAP

Use Output Tone Map to adjust the image contrast when displaying the camera output.

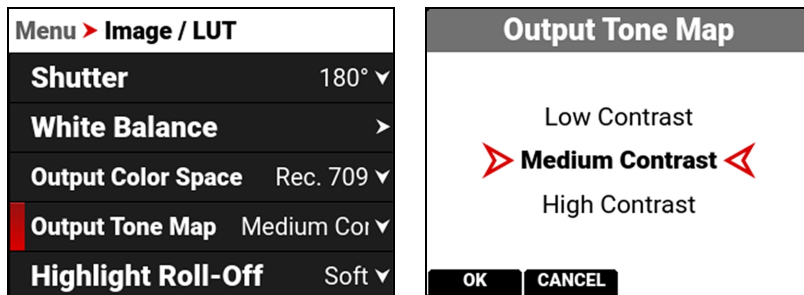

When shooting in R3D format, the camera stores this as metadata, which you can adjust non-destructively in post-production after filming.

The Output Tone Map selections include:

- Low Contrast - Low contrast is applied to the image
- Medium Contrast - Medium contrast is applied to the image (default)
- High Contrast - High contrast is applied to the image

## HIGHLIGHT ROLL-OFF

Use Highlight Roll-Off to select the desired highlight compression to use when displaying the camera output.

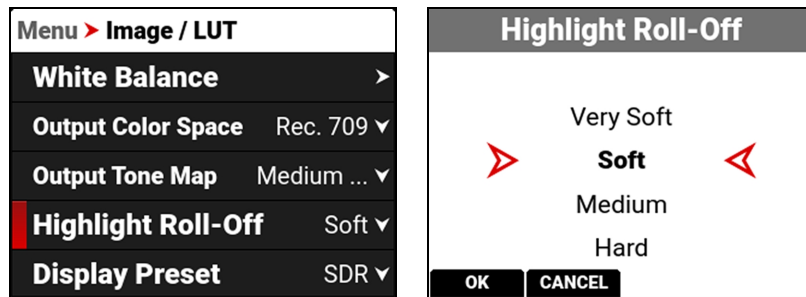

When shooting in R3D format, the camera stores this as metadata, which you can adjust non-destructively in post-production after filming.

The Highlight Roll-Off selections include:

- Very Soft - The lightest compression is applied to the image highlights
- Soft - Soft compression is applied to the image highlights (default)
- Medium - Medium compression is applied to the image highlights
- Hard - The highest compression is applied to the image highlights

## DISPLAY PRESET

Use Display Preset to select the gamma of the displayed preview image for the SDI ports:

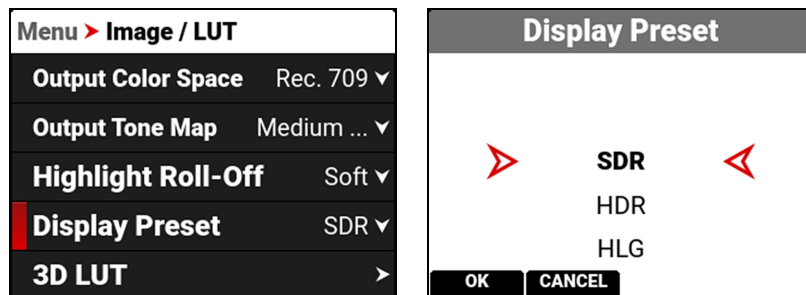

When shooting in R3D format, the camera stores this as metadata, which you can adjust non-destructively in post-production after filming.

The Display Preset allows you to select the gamma for the camera preview and monitor output.

Each monitor is designed to display using a specific gamma. Most monitors use SDR. However, some support HDR and HLG gamma signals. Select the display preset that works best with your monitor.

The selections are:

- SDR - Standard Dynamic Range (default)
- HDR - High Dynamic Range
- HLG - Hybrid Log-Gamma

Standard-dynamic-range (SDR) video describes images or video using a conventional gamma curve signal.

High-dynamic-range (HDR) video images are recorded using the SMPTE-2084 PQ curve. This technology captures and outputs a greater range of luminance than images recorded using standard-dynamic-range (SDR) methods.

Hybrid log-gamma (HLG) delivers HDR resolution without the need for metadata. This allows HLG to display well on SDR and HDR monitors.

### 3D LUT

Use the 3D LUT menu to apply and manage the camera's Look-Up Tables (LUTs).

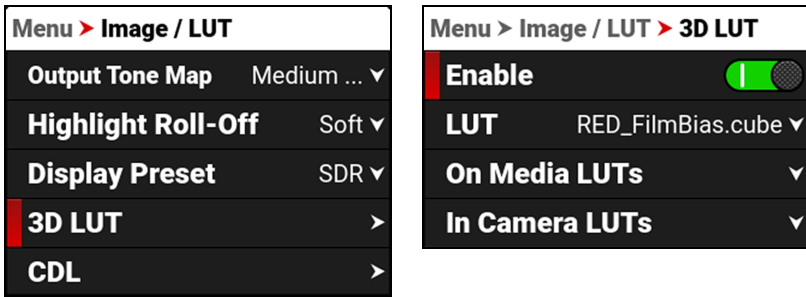

### LUT

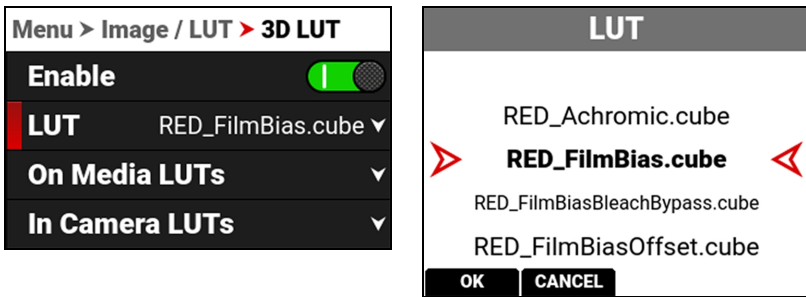

When you are recording in the ProRes format, you can choose to irreversibly encode (bake) the 3D LUT into the recorded file. For more information, refer to the [ProRes Color Profile](#) section.

When you are recording in the R3D format, this LUT will be saved along with each clip on which it is activated during recording. The output file name format for the LUT is clip\_LUT Name.cube.

The LUT is non-destructive, and it is reversible, when recording in the R3D format.

### ON MEDIA LUTS

To import 3D LUTs from media, go to **MENU > IMAGE / LUT > 3D LUT > On Media LUTs**.

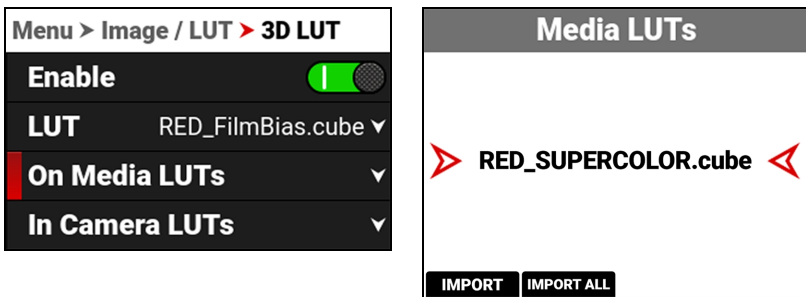

3D LUTs can be imported from media to the camera. When importing 3D LUTs from media to the camera, the 3D LUTs must be saved on the root path of your media, in a folder titled "luts."

From On Media LUTs, you can:

- Import the selected 3D LUT from the media to the camera
- Import all 3D LUTs from the media to the camera

When you copy LUTs from a computer to the media, make sure that the card reader is not set to read only.



## IN CAMERA LUTS

To export and delete 3D LUTs stored in the camera, go to **MENU > IMAGE / LUT > 3D LUT > In Camera LUTs**.

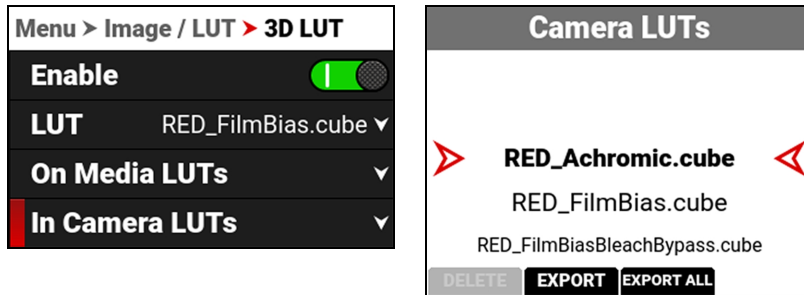

You can export 3D LUTs stored on the camera, to media, to use on other cameras. When you export 3D LUTs from the camera to media, the 3D LUTs are saved to a folder on the media called "luts."

**NOTE:** When a LUT is active during record, it will automatically be saved along with the recorded clip.

From In Camera LUTs you can:

- Delete a selected 3D LUT from the camera
- Export a selected 3D LUT from the camera to the media
- Export all 3D LUTs from the camera to the media

## CDL

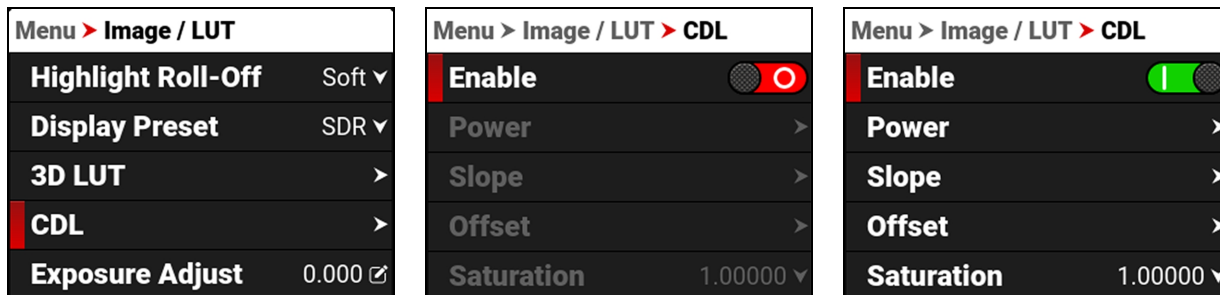

The Color Decision List (CDL) allows you define the look of the camera's colors in your project.

Use the CDL menu to:

- Enable the CDLs
- Configure **CDL Power**
- Configure **CDL Slope**
- Configure **CDL Offset**
- Configure **CDL Saturation**

## MANAGE CDLS

Use the CDLs menu to import and export CDLs.

CDLs can be stored on the camera or transferred to media to be shared with other cameras. When exporting CDLs from camera to media, the CDLs are saved to a folder on the media called "cdls". When importing CDLs from media to the camera, the CDLs must be stored on the media in a folder called "cdls."

When you record with a CDL in both ProRes and R3D formats, the camera automatically saves the CDL together with the clip. The output file name format for the CDL is `clip_CDL Name`.

To export selected CDLs from the camera to the media, refer to the **In Camera CDLs** section.

To import selected CDLs from the media to the camera, refer to the **On Media CDL** section.

## CDL OVERVIEW

A Color Decision List (CDL) is a metadata file format developed by the American Society of Cinematographers (ASC) to exchange standard color correction information between post-production tools. This non-destructive color adjustment layer simplifies the versioning of looks by updating simple metadata without the need to re-transfer the image data.

CDLs are very common in VFX workflows because the VFX artist needs both the ungraded shot and the intended look. The ungraded shot allows the artist to comp in truly linear light, and the intended look is needed to confirm that the individual plates still hold together after the grade is applied.

## SLOPE, OFFSET AND POWER

The three CDL tone curve parameters are Slope, Offset and Power. These algorithms allow the camera to modify the recorded image.

- Slope multiplies the incoming data
- Offset is sum of the incoming data
- Power is a power function to the incoming data

These three relate to Gain, Lift, and Gamma in the following ways:

- Slope = Gain  
Gain Adjusts highlights.
- Offset = Lift  
Lift Increases the value of dark colors.
- Power = Gamma  
Gamma adjusts midtones.

These three relate to each other in the following ways:

Slope= input x slope

Offset= (input x slope) + offset

Power= ((input x slope) + offset) ^ power

The formula for ASC CDL color correction is:

$$out = ((i \times s) + o)^p$$

where

- out* is the color graded pixel code value
- i* is the input pixel code value (0=black, 1=white)
- s* is slope (any number 0 or greater, nominal value is 1.0)
- o* is offset (any number, nominal value is 0)
- p* is power (any number greater than 0, nominal value is 1.0)

The formula is applied to the three color values for each pixel using the corresponding slope, offset, and power numbers for each color channel.

## SATURATION

A fourth parameter “Saturation” is achieved by converting the *out* data in a Luma and Chroma component. The Chroma Signal is then multiplied by the “Saturation” parameter.

## FILM GRADE AND VIDEO GRADE

With Slope and Offset you can produce both a Film Grade “Exposure” and “Contrast” and a Video Grade “Lift” and “Gain”.

- Exposure is achieved by Offset
- Contrast is achieved by a combination of Offset and Slope
- Gain is achieved by Slope
- Lift is achieved by a combination of Offset and Slope
- Gamma is achieved by Power

## CDL POWER

The CDL Power settings control the power of the Red, Green, Blue, color data.

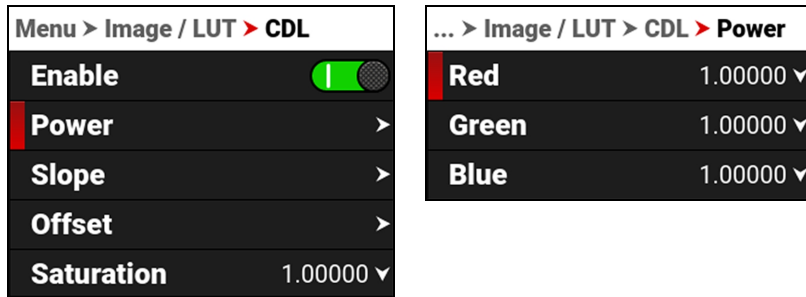

Use the CDL Power menu to adjust the power of the Red, Green, and Blue CDL data.

## CDL POWER SETTINGS

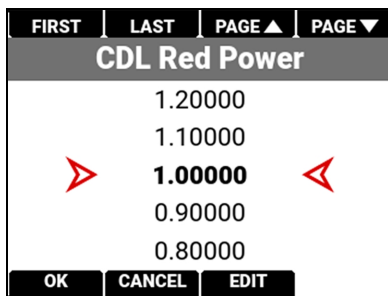

The CDL Power settings range from 0.00000 to 4.00000. The default CDL Power setting for each color is 1.00000.

## CDL SLOPE

The CDL Slope settings multiply the incoming RGB data.

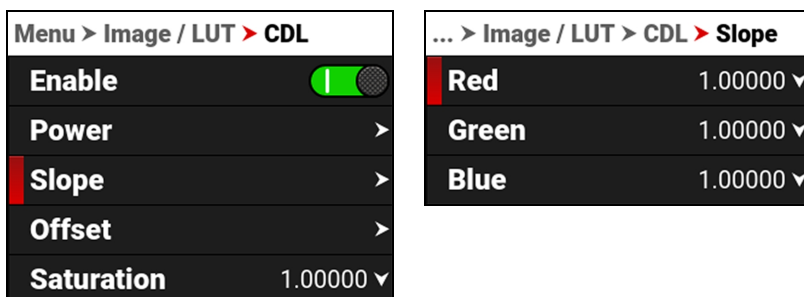

Use the CDL Slope menu to set the slope of the red, green, and blue signals.

## SLOPE SETTINGS

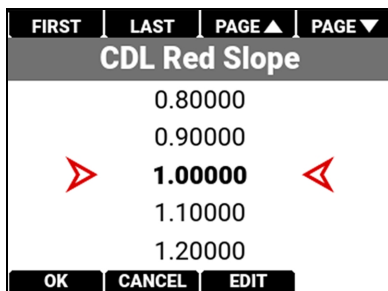

The CDL Slope settings range from 0.00000 to 2.00000. The default CDL Slope setting for each color is 1.00000.

## CDL OFFSET

The CDL Offset settings control the offset of the RGB color data.

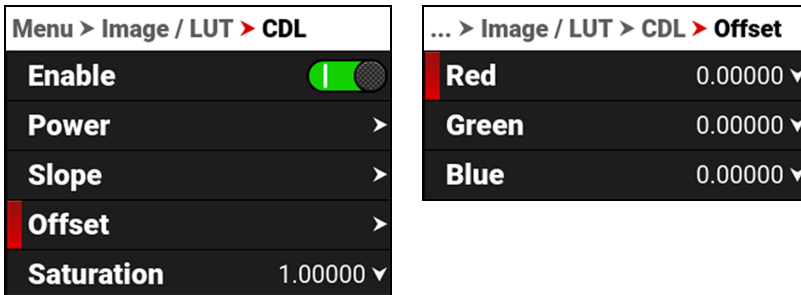

Use the CDL Offset menu to adjust the offset of the **CDL Slope** for the Red, Green, and Blue CDL data.

## RED GREEN AND BLUE OFFSETS

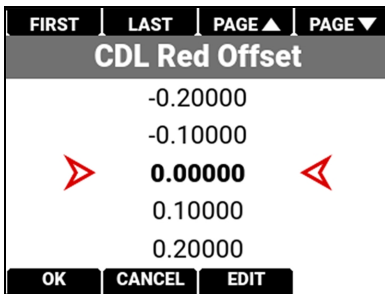

These CDL Offset settings range from -1.00000 to 1.00000. The default CDL Offset setting for each color is 0.00000.

## CDL SATURATION

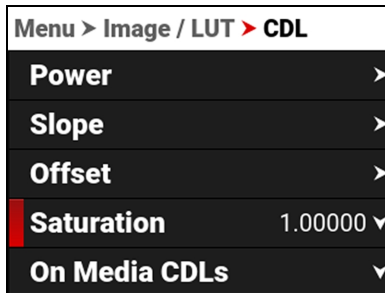

The CDL Saturation settings control the intensity of the color data.

Use the CDL Saturation menu to adjust the intensity of the image color.

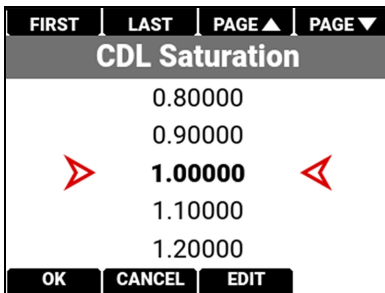

The CDL Saturation settings range from 0.00000 to 4.00000. The default CDL Saturation setting is 1.00000.

## ON MEDIA CDL

Use On Media CDLs to copy CDLs stored on the media and store them on the camera.

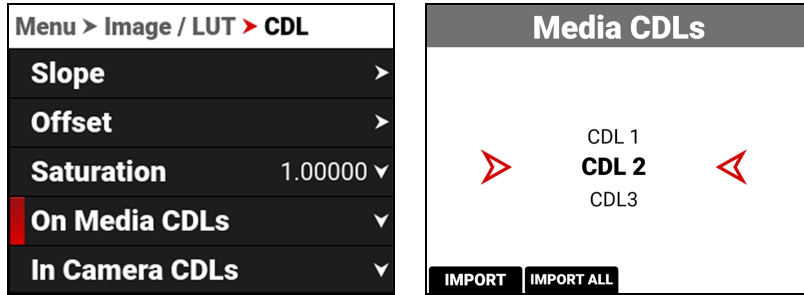

CDLs can be imported from media to the camera. When importing CDLs from media to the camera, the CDLs are saved to a folder on the camera called "cdls."

From Media CDLs you can import the selected CDL from the media to the camera or import all of the CDLs from the media to the camera.

When you copy CDLs from a computer to the media, make sure that the card reader is not set to Read Only.

## IN CAMERA CDLS

Use In Camera CDLs to copy CDLs stored on the camera and store them on the media. You can also select which stored CDLs you want the camera to use.

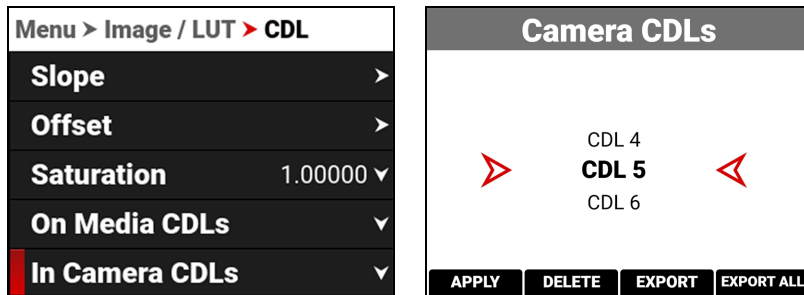

CDLs can be exported from the camera to the media. When exporting CDLs from camera to the media, the CDLs are saved to a folder on the media called "cdls."

From Camera CDLs you can apply the selected CDL to the camera, delete the selected CDL from the camera, export the selected CDL from the camera to the media, or export all of the CDLs from the camera to the media.

## EXPOSURE ADJUST

Use Exposure Adjust to manually fine-tune the midtone exposure level.

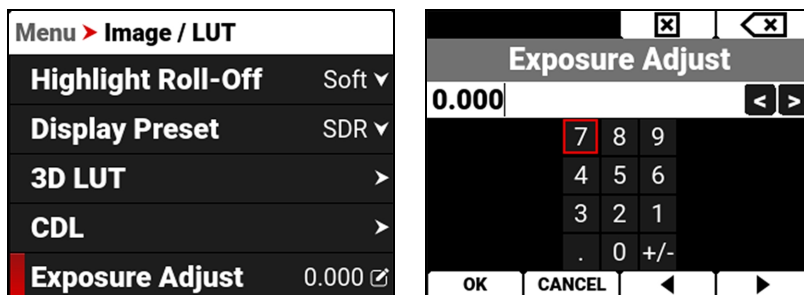

The Exposure Adjust range is -8.000 to 8.000. The default is 0.000.

Exposure Adjust allows you to adjust the midtone exposure levels while preserving the highlights and shadows, even when changed substantially. The Exposure Adjust setting is expressed in terms of relative exposure value (EV), where each unit represents a 1-stop change in midtone exposure level.

## PROJECT SETTINGS MENU

The Project Settings menu contains the camera's main recording configuration settings.

From the camera LCD menu, navigate to Project Settings and press SEL:

| Menu                    |   | Menu > Project Settings |            |
|-------------------------|---|-------------------------|------------|
| Image / LUT             | > | <b>Format</b>           | 8K 17:9 >  |
| <b>Project Settings</b> | > | Recording Frame Rate    | 23.98FPS ▼ |
| Audio / TC              | > | Project Time Base       | 23.98FPS ▼ |
| Monitoring              | > | File Format             | R3D ▼      |
| Media                   | > | R3D Quality             | MQ ▼       |

Use the Project Settings menu to configure the recording settings:

| ITEM                 | DETAILS   |
|----------------------|---|
| Format               | Size of the area captured by the sensor   |
| Recording Frame Rate | Frames recorded per second  |
| Project Time Base    | Image playback rate   |
| File Format          | Select the file recording format  |
| R3D Quality          | Compression level of the recorded image file  |
| ProRes Proxy Record  | Records a ProRes Proxy file along with the R3D file   |
| ProRes Resolution    | Select the ProRes file resolution   |
| ProRes Codec         | Select the ProRes file codec  |
| ProRes Color Profile | Select the color profile you want baked in the ProRes   |
| Pre-Record           | Enable and configure a pre-record clip  |
| Recording Mode       | Select normal motion or time-lapse recording  |
| Timelapse            | Select time-lapse settings  |
| Frame Limit          | Configure a frame limit for recording   |
| Slate                | Enter the camera ID, camera position, camera operator, scene, shot, take, production, director, DoP, and unit |

## FORMAT

Use the Format setting to designate how much of the sensor the camera should use to capture images.

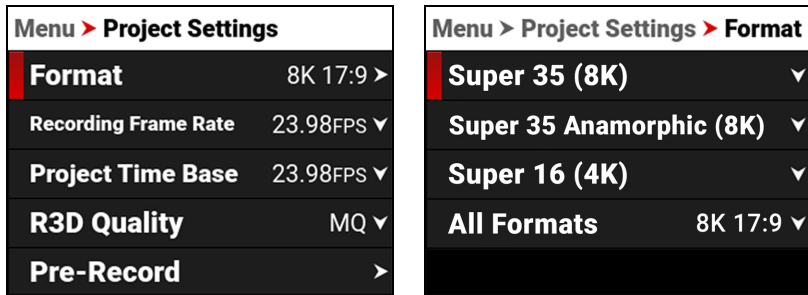

Use the Format menu to configure the camera's sensor capture area settings:

| ITEM                     | DETAILS   |
|--------------------------|---|
| Super 35 (8K)            | Select from Super 35 (8K) sensor capture areas            |
| Super 35 Anamorphic (8K) | Select from Super 35 anamorphic (8K) sensor capture areas |
| Super 16 (4K)            | Select from Super 16 (4K) sensor capture areas            |
| All Formats              | Select from all sensor capture areas                      |

The available aspect ratios are determined by the selected resolution. The default format setting is 8K 17:9.

When you lower the resolution on the camera, only a portion of the sensor is used. The camera does not downscale from the 8K 17:9 format when recording RAW.

## SUPER 35 (8K)

Use the Super 35 (8K) format setting to designate how much of the sensor the camera should use to capture images.

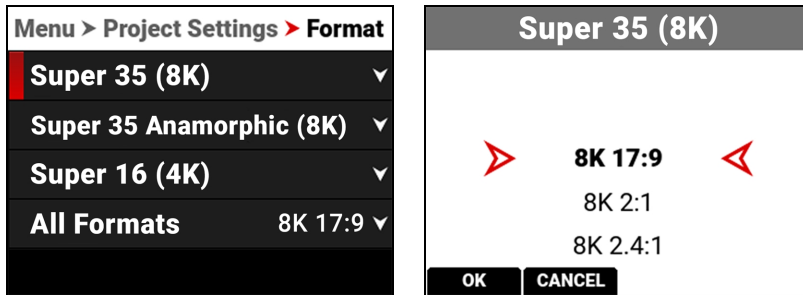

The available aspect ratios are determined by the selected resolution.

## SUPER 35 (8K) FORMAT SPECIFICATIONS

This table contains the dimensions of the sensor area in pixels and in millimeters used by each Super 35 (8K) format. These dimensions are close approximations.

The default format is 8K 17:9.

| FORMAT   | DIMENSION (PIXELS) |        | DIMENSIONS (MM) |        |          |
|----------|--------------------|--------|-----------------|--------|----------|
|          | Width              | Height | Width           | Height | Diagonal |
| 8K 17:9  | 8192               | 4320   | 26.21           | 13.82  | 29.64    |
| 8K 2:1   | 8192               | 4096   | 26.21           | 13.11  | 29.31    |
| 8K 2.4:1 | 8192               | 3456   | 26.21           | 11.06  | 28.45    |
| 8K 16:9  | 7680               | 4320   | 24.58           | 13.82  | 28.20    |
| 8K 1:1   | 4320               | 4320   | 13.82           | 13.82  | 19.55    |



## SUPER 35 ANAMORPHIC (8K)

Use the Super 35 Anamorphic (8K) format setting to designate how much of the sensor the camera should use to capture anamorphic images with the appropriate de-squeeze ratio.

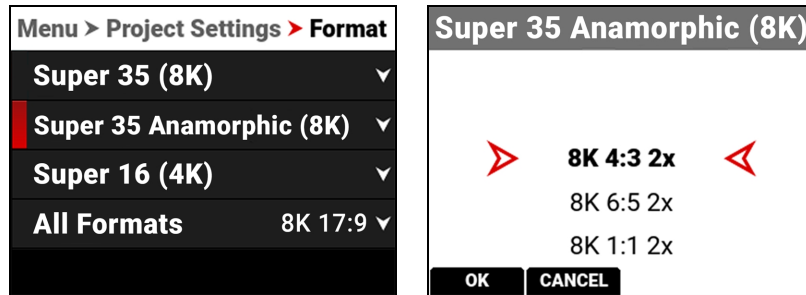

The available aspect ratios are determined by the selected resolution.

When you lower the resolution on the camera, only a portion of the sensor is used. The camera does not downscale from the format when recording RAW.

## SUPER 35 ANAMORPHIC (8K) FORMAT SPECIFICATIONS

This table contains the dimensions of the sensor area in pixels and in millimeters used by each Super 35 Anamorphic (8K) format. These dimensions are close approximations.

The default format is 8K 4:3 2x.

| FORMAT        | DIMENSION (PIXELS) |        | DIMENSIONS (MM) |        |          |
|---------------|--------------------|--------|-----------------|--------|----------|
|               | Width              | Height | Width           | Height | Diagonal |
| 8K 4:3 2x     | 5760               | 4320   | 18.43           | 13.82  | 23.04    |
| 8K 6:5 2x     | 5184               | 4320   | 16.59           | 13.82  | 21.59    |
| 8K 1:1 2x     | 4320               | 4320   | 13.82           | 13.82  | 19.55    |
| 8K 3:2 1.8x   | 6480               | 4320   | 20.74           | 13.82  | 24.92    |
| 8K 4:3 1.8x   | 5758               | 4320   | 18.43           | 13.82  | 23.04    |
| 8K 3:2 1.6x   | 6480               | 4320   | 20.74           | 13.82  | 24.92    |
| 8K 16:9 1.5x  | 7680               | 4320   | 24.58           | 13.82  | 28.20    |
| 8K 17:9 1.3x  | 8192               | 4320   | 26.21           | 13.82  | 29.64    |
| 8K 16:9 1.3x  | 7680               | 4320   | 24.58           | 13.82  | 28.20    |
| 8K 17:9 1.25x | 8192               | 4320   | 26.21           | 13.82  | 29.64    |

## SUPER 16 (4K)

Use the Super 16 (4K) format setting to designate how much of the sensor the camera should use to capture images.

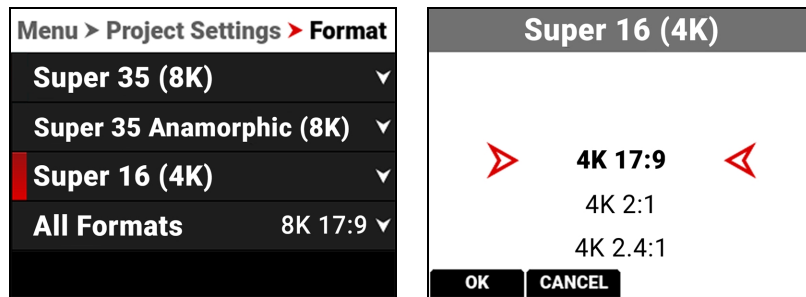

The available aspect ratios are determined by the selected resolution.

When you lower the resolution on the camera, only a portion of the sensor is used. The camera does not downscale from the format when recording RAW.

## SUPER 16 (4K) FORMAT SPECIFICATIONS

This table contains the dimensions of the sensor area in pixels and in millimeters used by each Super 16 (4K) format. These dimensions are close approximations.

The default format is 4K 17:9.

| FORMAT   | DIMENSION (PIXELS) |        | DIMENSIONS (MM) |        |          |
|----------|--------------------|--------|-----------------|--------|----------|
|          | Width              | Height | Width           | Height | Diagonal |
| 4K 17:9  | 3072               | 1620   | 13.11           | 6.91   | 14.82    |
| 4K 2:1   | 3072               | 1536   | 13.11           | 6.55   | 14.65    |
| 4K 2.4:1 | 3072               | 1296   | 13.11           | 5.53   | 14.23    |
| 4K 16:9  | 2880               | 1620   | 12.29           | 6.91   | 14.10    |
| 4K 1:1   | 1620               | 1620   | 6.91            | 6.91   | 9.78     |

## ALL FORMATS

Use the All Formats setting to select from all of the possible formats to designate how much of the sensor the camera should use to capture images.

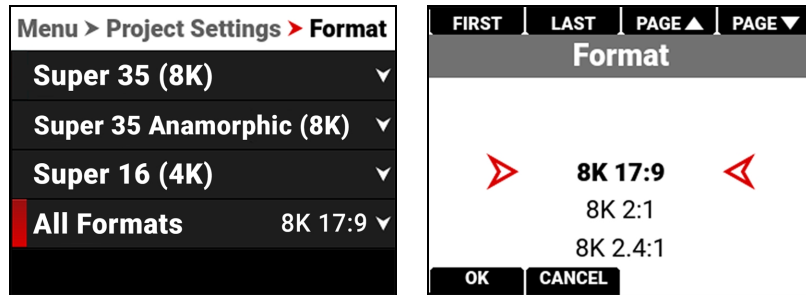

The available aspect ratios are determined by the selected resolution.

When you lower the resolution on the camera, only a portion of the sensor is used. The camera does not downscale from the 8K 17:9 format when recording RAW.

## FORMAT SPECIFICATIONS

This table contains the dimensions of the sensor area in Pixels and in Millimeters used by all of the camera formats. These dimensions are close approximations. The default setting is 8K 17:9.

| FORMAT        | DIMENSION (PIXELS) |        | DIMENSIONS (MM) |        |          |
|---------------|--------------------|--------|-----------------|--------|----------|
|               | Width              | Height | Width           | Height | Diagonal |
| 8K 17:9       | 8192               | 4320   | 26.21           | 13.82  | 29.64    |
| 8K 2:1        | 8192               | 4096   | 26.21           | 13.11  | 29.31    |
| 8K 2.4:1      | 8192               | 3456   | 26.21           | 11.06  | 28.45    |
| 8K 16:9       | 7680               | 4320   | 24.58           | 13.82  | 28.20    |
| 8K 1:1        | 4320               | 4320   | 13.82           | 13.82  | 19.55    |
| 8K 3:2 1.8x   | 6480               | 4320   | 20.74           | 13.82  | 24.92    |
| 8K 4:3 2x     | 5760               | 4320   | 18.43           | 13.82  | 23.04    |
| 8K 6:5 2x     | 5184               | 4320   | 16.59           | 13.82  | 21.59    |
| 8K 1:1 2x     | 4320               | 4320   | 13.82           | 13.82  | 19.55    |
| 8K 4:3 1.8x   | 5760               | 4320   | 18.43           | 13.82  | 23.04    |
| 8K 3:2 1.6x   | 6480               | 4320   | 20.74           | 13.82  | 24.92    |
| 8K 16:9 1.5x  | 7680               | 4320   | 24.58           | 13.82  | 28.20    |
| 8K 17:9 1.3x  | 8192               | 4320   | 26.21           | 13.82  | 29.64    |
| 8K 16:9 1.3x  | 7680               | 4320   | 24.58           | 13.82  | 28.20    |
| 8K 17:9 1.25x | 8192               | 4320   | 26.21           | 13.82  | 29.64    |
| 7K 17:9       | 7168               | 3780   | 22.94           | 12.10  | 25.93    |
| 7K 2:1        | 7168               | 3584   | 22.94           | 11.47  | 25.65    |
| 7K 2.4:1      | 7168               | 3002   | 22.94           | 9.68   | 24.90    |
| 7K 16:9       | 6720               | 3780   | 21.50           | 12.10  | 24.67    |
| 7K 1:1        | 3780               | 3780   | 12.10           | 12.10  | 17.11    |
| 6K 17:9       | 6144               | 3240   | 19.66           | 10.37  | 22.23    |

# V-RAPTOR™ 8K S35 OPERATION GUIDE

| FORMAT   | DIMENSION (PIXELS) |        | DIMENSIONS (MM) |        |          |
|----------|--------------------|--------|-----------------|--------|----------|
|          | Width              | Height | Width           | Height | Diagonal |
| 6K 2:1   | 6144               | 3072   | 19.66           | 9.83   | 21.98    |
| 6K 2.4:1 | 6144               | 2592   | 19.66           | 8.29   | 21.34    |
| 6K 16:9  | 5760               | 3240   | 18.43           | 10.37  | 21.15    |
| 6K 1:1   | 3240               | 3240   | 10.37           | 10.37  | 14.66    |
| 5K 17:9  | 5120               | 2700   | 16.38           | 8.64   | 18.52    |
| 5K 2:1   | 5120               | 2560   | 16.38           | 8.19   | 18.32    |
| 5K 2.4:1 | 5120               | 2160   | 15.36           | 8.64   | 17.62    |
| 5K 16:9  | 4800               | 2700   | 15.36           | 8.64   | 17.62    |
| 5K 1:1   | 2700               | 2700   | 8.64            | 8.64   | 12.22    |
| 4K 17:9  | 4096               | 2160   | 13.11           | 6.91   | 14.82    |
| 4K 2:1   | 4096               | 2048   | 13.11           | 6.55   | 14.65    |
| 4K 2.4:1 | 4096               | 1728   | 13.11           | 5.53   | 14.23    |
| 4K 16:9  | 3840               | 2160   | 12.29           | 6.91   | 14.10    |
| 4K 1:1   | 2160               | 2160   | 6.91            | 6.91   | 9.78     |
| 4K 8:1   | 4096               | 512    | 13.11           | 1.64   | 13.21    |
| 3K 17:9  | 3072               | 1620   | 9.83            | 5.18   | 11.11    |
| 3K 2:1   | 3072               | 1536   | 9.83            | 4.92   | 10.99    |
| 3K 2.4:1 | 3072               | 1296   | 9.83            | 4.15   | 10.67    |
| 3K 16:9  | 2880               | 1620   | 9.83            | 5.18   | 11.11    |
| 3K 1:1   | 1620               | 1620   | 5.18            | 5.18   | 7.33     |
| 2K 17:9  | 2048               | 1080   | 6.55            | 3.46   | 7.41     |
| 2K 2:1   | 2048               | 1024   | 6.55            | 3.28   | 7.33     |
| 2K 2.4:1 | 2048               | 864    | 6.55            | 2.76   | 7.11     |
| 2K 16:9  | 1920               | 1080   | 6.14            | 3.46   | 7.05     |
| 2K 1:1   | 1080               | 1080   | 3.46            | 3.46   | 4.89     |

## RECORDING FRAME RATE

Use Recording Frame Rate to select the recording frame rate (also referred to as the capture frame rate).

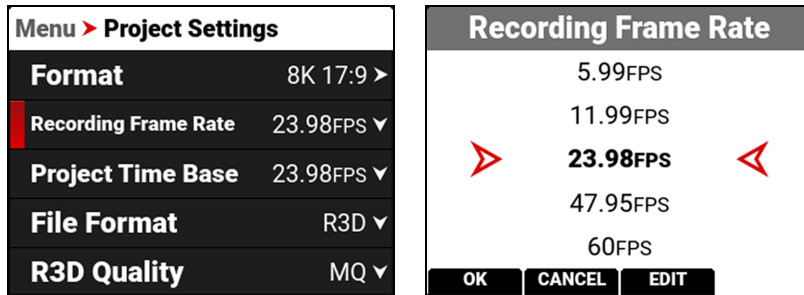

The recording frame rate is the number of frames per second (FPS) that are recorded. The recording frame rate is different from the project time base, which is the rate at which the footage will be played back. Lower values than the project time base will result in under-cranking (fast motion playback) and values larger than the project time base will result in over-cranking (slow motion playback).

The maximum frame rate for each format is determined by **Project Time Base** and **Format**.

When you select a Project Time Base, the camera automatically selects a matching Recording Frame Rate and an R3D Quality (when possible). You must change the Recording Frame Rate and R3D Quality after the Project Time Base to select a different setting.

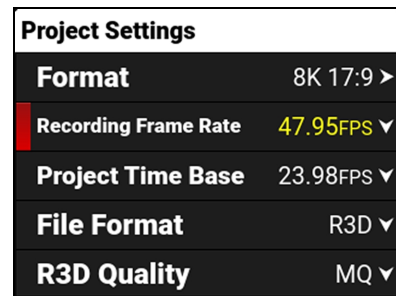

A Recording Frame Rate highlighted in **yellow** will result in playback occurring at a different frame rate than the original recording, and will record varispeed audio.

## FORMATS AND FRAME RATES

This table lists the camera's maximum recording frame rates. These rates are based on a Project Time Base setting of 24 frames per second (24 FPS).

| FORMAT   | FPS | FORMAT   | FPS | FORMAT   | FPS | FORMAT   | FPS  |
|----------|-----|----------|-----|----------|-----|----------|------|
| 8K 17:9  | 120 | 6K 17:9  | 160 | 4K 17:9  | 240 | 2K 17:9  | 480  |
| 8K 2:1   | 126 | 6K 2:1   | 168 | 4K 2:1   | 253 | 2K 2:1   | 505  |
| 8K 2.4:1 | 150 | 6K 2.4:1 | 200 | 4K 2.4:1 | 300 | 2K 2.4:1 | 600  |
| 8K 16:9  | 120 | 6K 16:9  | 160 | 4K 16:9  | 240 | 2K 16:9  | 480  |
| 8K 1:1   | 120 | 6K 1:1   | 160 | 4K 1:1   | 240 | 2K 1:1   | 480  |
| 7K 17:9  | 140 | 5K 17:9  | 192 | 3K 17:9  | 320 | 4K 8:1   | 1000 |
| 7K 2:1   | 144 | 5K 2:1   | 202 | 3K 2:1   | 337 |          |      |
| 7K 2.4:1 | 175 | 5K 2.4:1 | 240 | 3K 2.4:1 | 400 |          |      |
| 7K 16:9  | 137 | 5K 16:9  | 192 | 3K 16:9  | 320 |          |      |
| 7K 1:1   | 137 | 5K 1:1   | 192 | 3K 1:1   | 320 |          |      |

## PROJECT TIME BASE

Use the Project Time Base setting to choose the playback rate for the recorded footage.

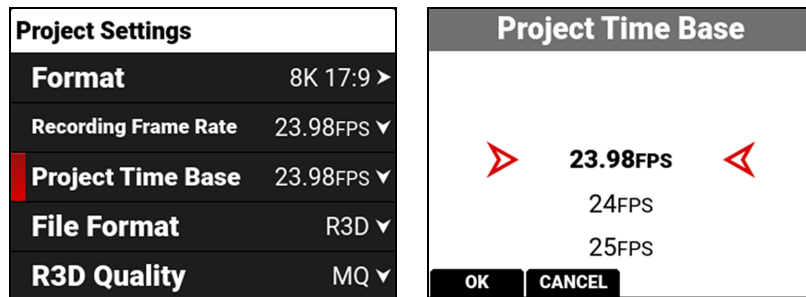

The following project time bases are available:

- 23.98 FPS (Default)
- 24.00 FPS
- 25.00 FPS
- 29.97 FPS
- 30.00 FPS
- 50.00 FPS
- 59.94 FPS
- 60.00 FPS

When you select the Project Time Base, it changes the Recording Frame Rate to the same setting (when possible).

When you change the Format, the Recording Frame Rate and Project Time Base do not automatically update. You must select the Project Time Base after you change the Format setting.

## FILE FORMAT

Use File Format to select the format that the camera uses to record image files.

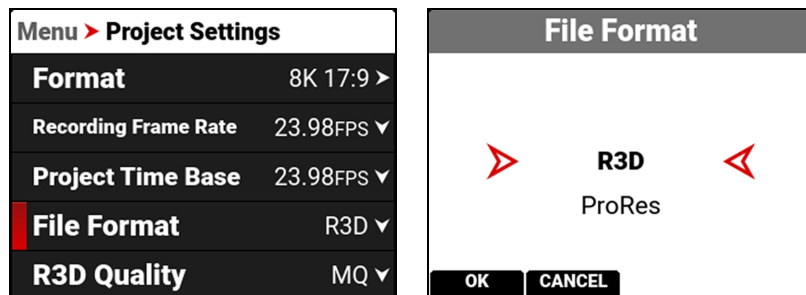

When you change the file format, a message warns you that the camera must be rebooted to complete the change:

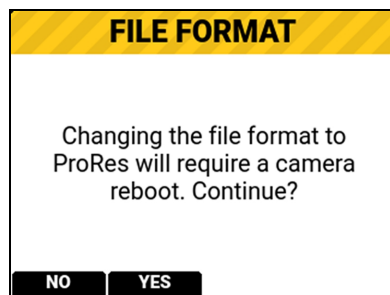

## R3D REDCODE FILE FORMAT

The RED R3D file format records images in a compressed RAW format. In comparison to Apple ProRes, REDCODE RAW data does not bake in image settings like ISO, saturation, or LUTs, allowing more flexibility in post-processing workflows without reducing image quality or dynamic range. Instead R3D files store the image settings as Metadata. You can open and process R3D files with REDCINE-X PRO or with non-linear editing (NLE) software that supports the RED SDK.

R3D is the camera's default file format.

## APPLE PRORES FORMAT

This section provides general information about recording Apple ProRes files with the camera, including:

- The maximum recording frame rate in ProRes is 120 frames per second (FPS).
- QuickTime files have the same metadata as the REDCODE RAW files. The metadata is per clip, and not per frame.
- You can select a **Format** from the **Project Settings Menu** and the camera will scale it to the target resolution you select in **ProRes Resolution**.
- Recording 4K ProRes files requires 4K and above formats in 17:9. When in ProRes, formats below 4K will automatically be recorded as 2K or HD.
- ProRes Proxy files are recorded in 2K for 17:9 formats and in HD for all others.
- For more information about Apple ProRes, including the data rates for each codec, refer to the [Apple ProRes White Paper](#).

## APPLE PRORES DESCRIPTION

The table below describes each supported Apple ProRes codec.

| NAME           | CHROMA SAMPLING                             | DATA RATE                       |
|----------------|---|---------------------------------|
| ProRes 4444 XQ | Y' C <sub>b</sub> C <sub>r</sub> +α 4:4:4:4 | 1697 Mbps at 4K 17:9 and 24 FPS |
| ProRes 4444    | Y' C <sub>b</sub> C <sub>r</sub> +α 4:4:4:4 | 1131 Mbps at 4K 17:9 and 24 FPS |
| ProRes 422 HQ  | Y' C <sub>b</sub> C <sub>r</sub> 4:2:2      | 754 Mbps at 4K 17:9 and 24 FPS  |
| ProRes 422     | Y' C <sub>b</sub> C <sub>r</sub> 4:2:2      | 503 Mbps at 4K 17:9 and 24 FPS  |
| ProRes 422 LT  | Y' C <sub>b</sub> C <sub>r</sub> 4:2:2      | 350 Mbps at 4K 17:9 and 24 FPS  |

## FILE STRUCTURE OF RECORDED APPLE PRORES FILES

When you record using R3D + ProRes Proxy, this is the file structure of the recorded files on the media:

- .RDM Folder
  - .RDC Folder
    - .mov
    - .R3D
    - .rtn (RED Thumbnail file)

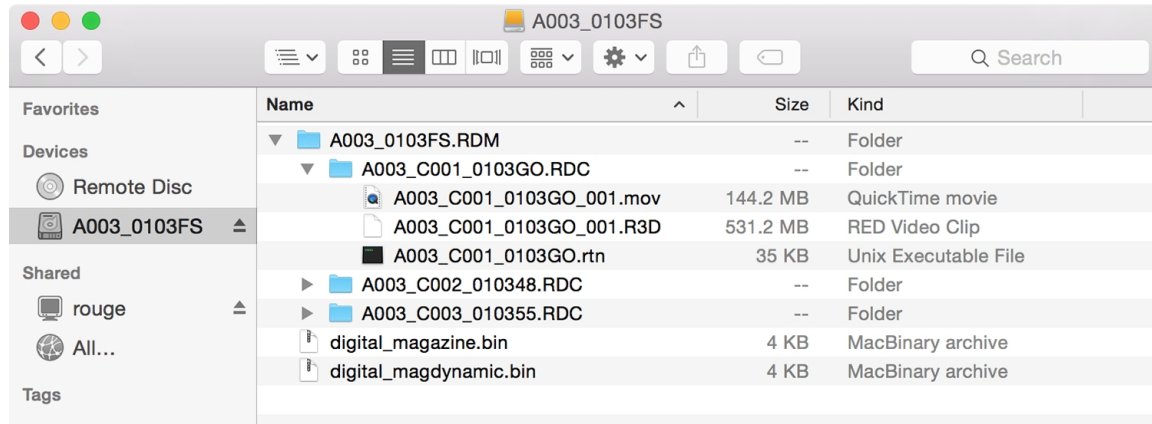

When you record using ProRes format, this is the file structure of the recorded files on the media:

- .RDM Folder
  - .RDC Folder
    - .mov

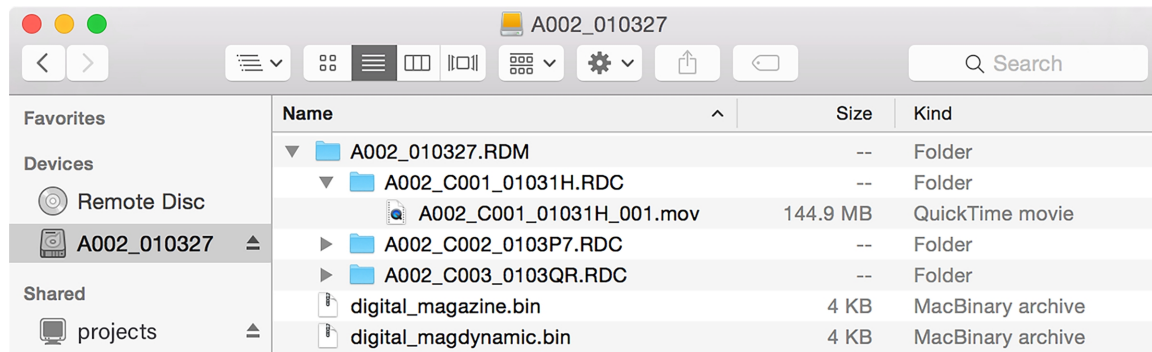



## R3D QUALITY

Use R3D Quality to select the R3D data rate the camera uses to record the image files.

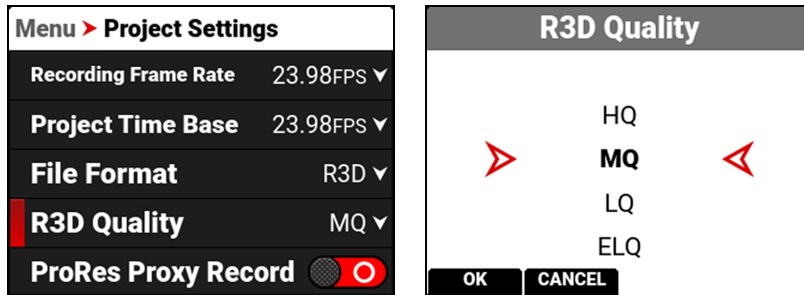

The R3D Quality selections include:

- HQ - High data rate and less recording time
- MQ - Medium data rate (default) and longer recording time
- LQ - Low data rate and long recording time
- ELQ - Lowest data rate and longest recording time

For high complexity scenes, VFX, and stills from motion workflows, RED recommends the HQ setting. For cinema (non-VFX) and high-end TV, RED recommends the MQ setting. For TV, online content, documentary and interviews, RED recommends the LQ setting. ELQ compression mode provides nearly 50% more recording time than LQ, and RED recommends using ELQ for scenes where the complexity is low or the final delivery resolution is lower than the acquisition resolution (downsampling).

### R3D QUALITY DATA RATES

| FORMAT  | 24P HQ   | 24P MQ   | 24P LQ   | 24P ELQ  |
|---------|----------|----------|----------|----------|
| 8K 17:9 | 425 MB/s | 298 MB/s | 186 MB/s | 100 MB/s |
| 6K 17:9 | 239 MB/s | 168 MB/s | 105 MB/s | 65 MB/s  |

## PRORES PROXY RECORD

You can enable the camera to record a ProRes proxy file along with the R3D file.

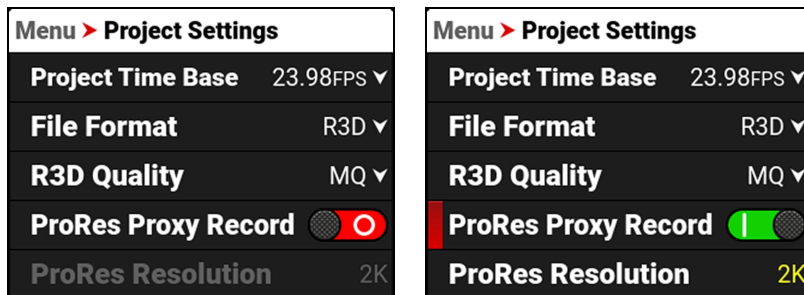

When ProRes Proxy is enabled, the ProRes menus are enabled.

- The setting for ProRes resolution is set to 2K (17:9) or HD, and you cannot change it.
- You can select from the **ProRes Codec** list and the **ProRes Color Profile**:

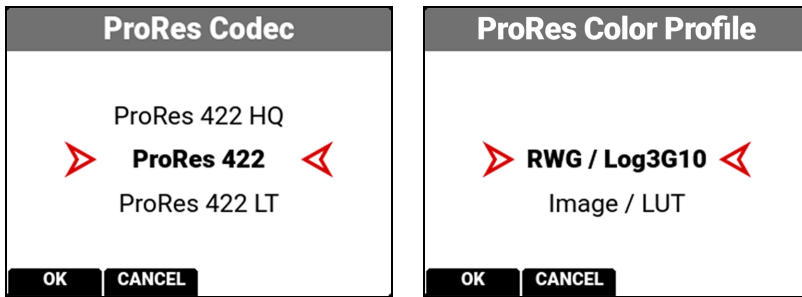

## PRORES RESOLUTION

Use ProRes Resolution to select the resolution to record when the **File Format** is set to ProRes. When you enable ProRes Proxy, the ProRes resolution is set automatically to 2K or HD.

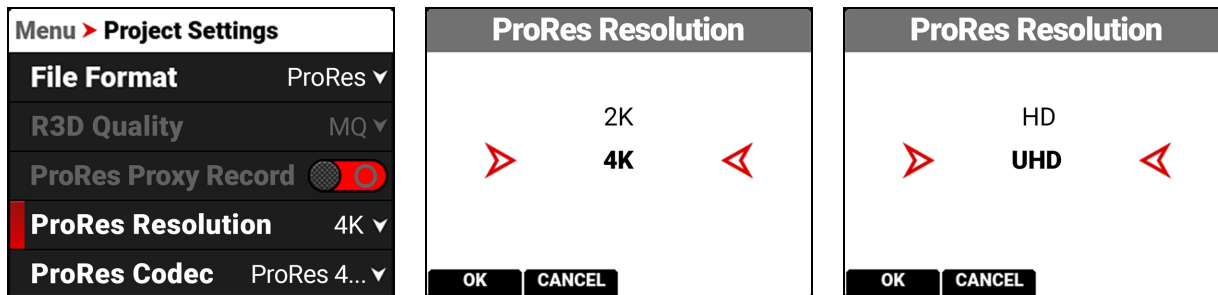

The ProRes Resolution selections include:

- HD (16:9)
- 2K (17:9)
- UHD (16:9)
- 4K (17:9, default)

The camera will downscale to achieve the selected ProRes resolution when the aspect ratios of your format and ProRes resolution do not match.

## PRORES CODEC

When you enable ProRes or R3D+ProRes Proxy as the **File Format**, you can select the ProRes Codec.

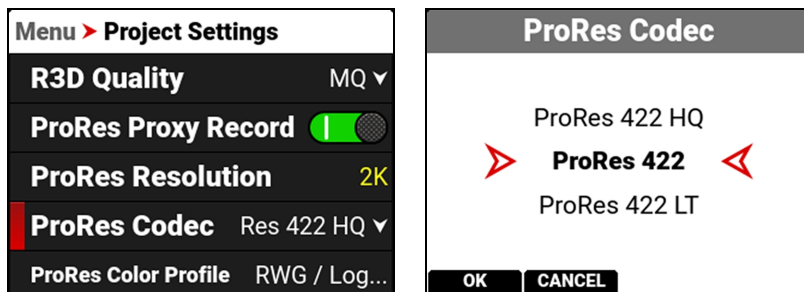

The ProRes Codec selections include:

## R3D+ProRes Proxy

- ProRes 422 HQ
- ProRes 422
- ProRes 422 LT

## ProRes

- ProRes 4444 XQ
- ProRes 4444
- ProRes 422 HQ
- ProRes 422
- ProRes 422 LT

## PRORES COLOR PROFILE

When you enable ProRes or ProRes Proxy as the **File Format** you can select the ProRes Color Profile settings.

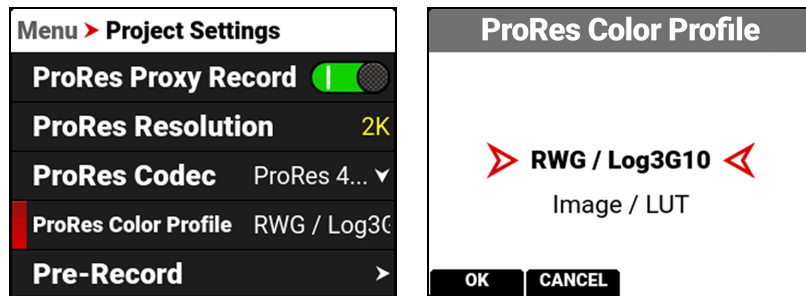

The ProRes Color Profile settings include:

- RWG/Log3G10 - REDWideGamutRGB color space and Log3G10 gamma curve
- Image / LUT - Applies all Image / LUT settings for **Output Color Space**, **Display Preset**, **3D LUT**, and **CDL**

**NOTE:** All ProRes Color Profile settings bake in both the ISO and the White Balance settings.

## PRE-RECORD

Use the Pre-Record menu to enable or disable Pre-Record, and to adjust the length of the Pre-Recorded clip.

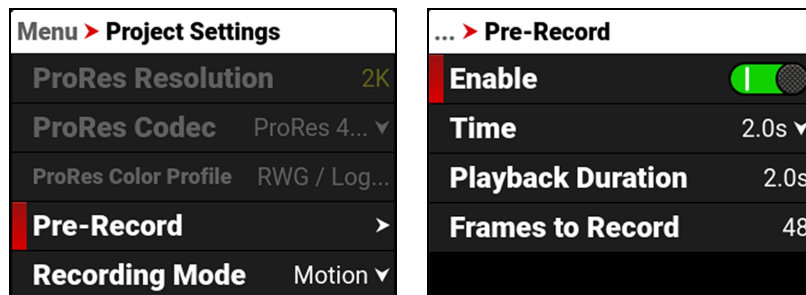

Pre-Record allows you to continually capture images to a small amount of memory while waiting to begin recording. This allows you to capture unexpected events such as, a whale breaching the water, or an athlete scoring a goal. When you finish recording, the pre-recorded clip is added to the beginning of the recording.

You can set the Pre-Record clip to record from half a second up to 30 seconds, depending on the format, file type, resolution, and quality. The default setting is 2 seconds at the default Project Time Base of 23.98 FPS.

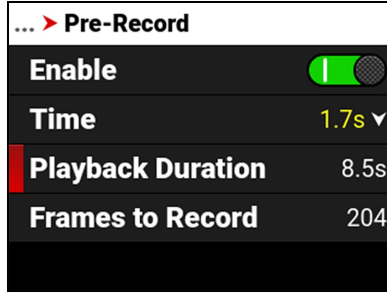
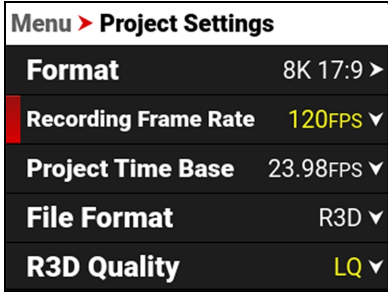

When the Recording Frame Rate and Project Time Base are set to unmatched rates, the time interval changes and is displayed in **yellow**.

For more information, refer to [Pre-Recording Content](#).

## ENABLE

Select Enable to toggle Pre-Record on and off.

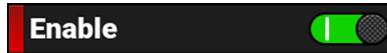
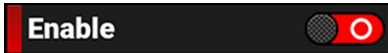

## TIME

Select Time to choose or enter the number of seconds to pre-record.

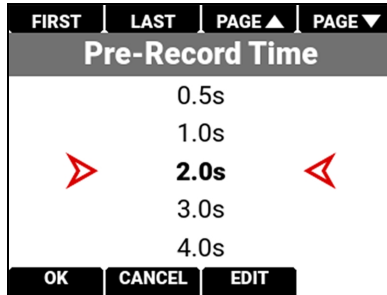
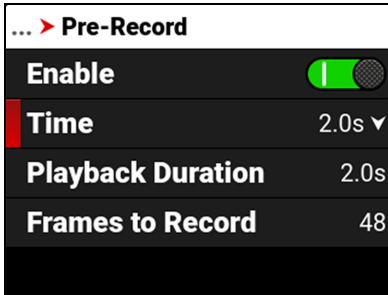

## PLAYBACK DURATION

Playback Duration displays the duration in seconds that the pre-record clip will last in playback.

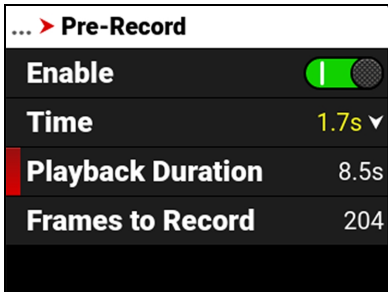

## FRAMES TO RECORD

Frames to Record displays the number of frames the pre-recorded clip will contain at the current settings.

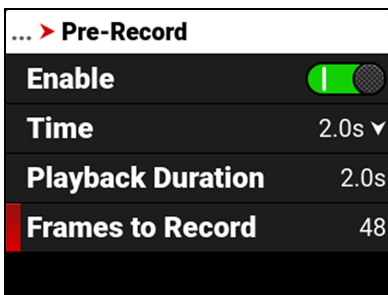

## RECORDING MODE

Use Recording Mode to select between normal motion recording or time-lapse recording.

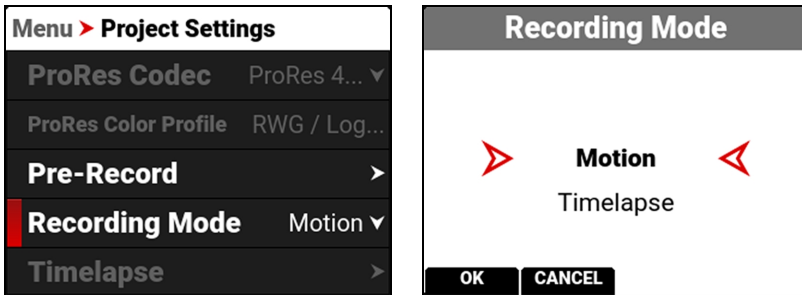

When you select Timelapse, the Timelapse option is enabled on the menu.

## TIMELAPSE

Use Timelapse to select the time-lapse settings.

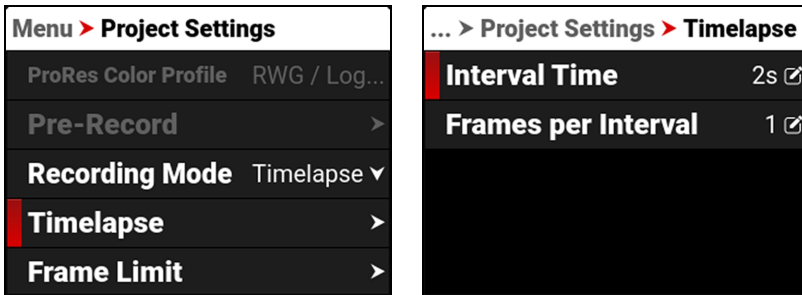

From Timelapse you can select the interval time between the group of frames per interval, and you can select the number of frames captured per interval.

## INTERVAL TIME

Select Interval Time to enter the elapsed time between the group of frames per interval.

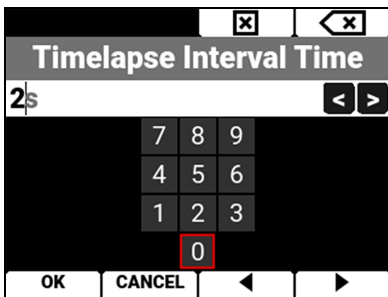

For example:

60s = 1 minute

3600s = 1 hour

86400s = 1 day

## FRAMES PER INTERVAL

Select Frames Per Interval to enter the number of frames to record per interval.

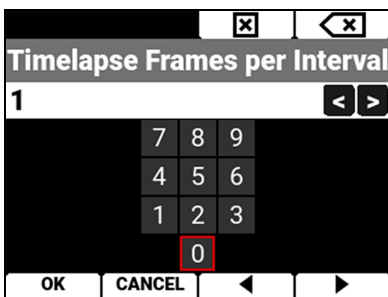

Adding more frames per interval allows you to have more flexibility in post (for example: image stacking).

## FRAME LIMIT

Use Frame Limit to limit the total number of frames recorded per clip. Frame limit applies to both Motion and Timelapse recording modes.

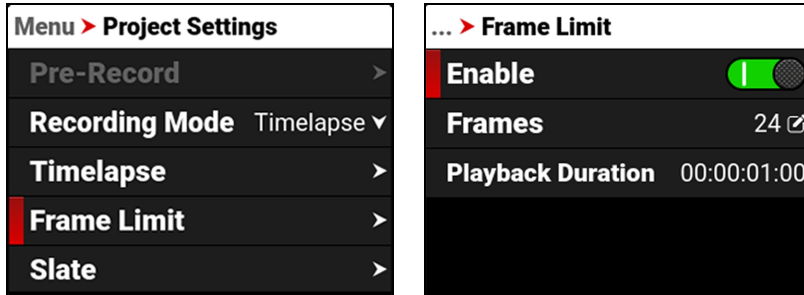

The Frame Limit selections include Enable, Frames, and Playback Duration.

### ENABLE

Select Enable to toggle the activation of the Frame Limit feature.



### FRAMES

Use frames to enter the maximum number of frames the clip can record.

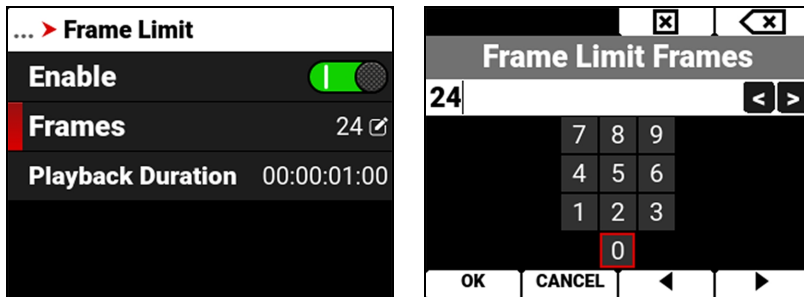

### PLAYBACK DURATION

Playback Duration displays the calculated playback duration of the clip with the selected Frame Limit and FPS.

For example, using 1440 Frames as a Frame Limit at 24 FPS results in one minute of playback duration.

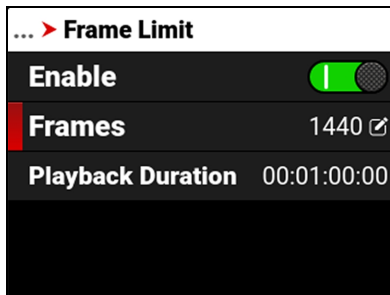

## SLATE

Use the Slate menu to enter information the camera adds when recording clips.

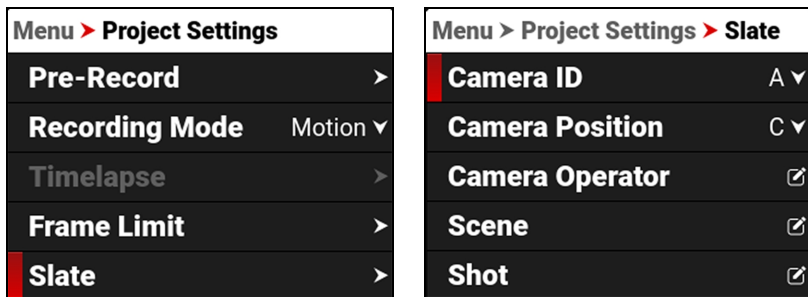

The information you can add to a clip includes:

- Camera ID
- Camera Position
- Camera Operator
- Scene
- Shot
- Take
- Production
- Director
- DoP
- Unit

**NOTE:** When you set the Camera ID and Camera Position, they are also set in the Media>Secure Format menu items.

## CAMERA ID

Use Camera ID to assign a camera ID when the camera records clips.

**NOTE:** You can also change the Camera ID by using Secure Format (refer to [Secure Format](#)).

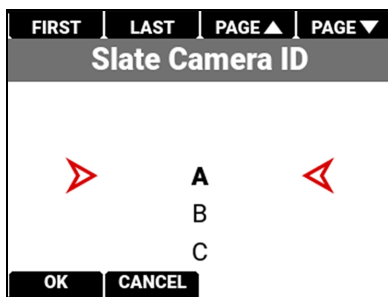

The camera IDs you can assign when recording a clip include the letters A-Z.

## CAMERA POSITION

Use Camera Position to assign a camera position letter when the camera records clips.

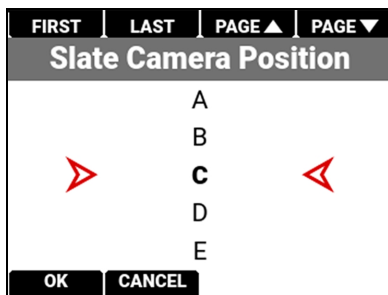

The camera positions you can assign when recording a clip include the letters A-Z.

## CAMERA OPERATOR

Use Camera Operator to enter the name of the camera operator.

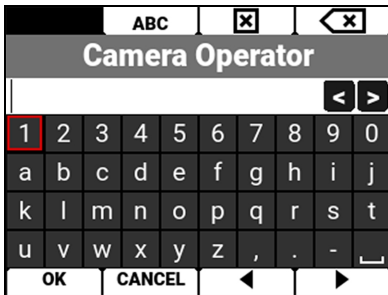

## SCENE

Use Scene to enter the scene name.

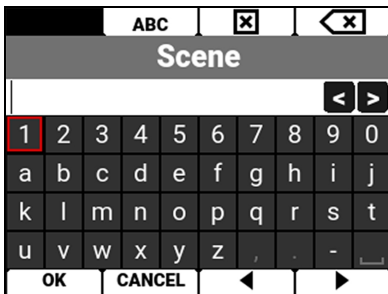

## SHOT

Use Shot to enter the number of the shot.

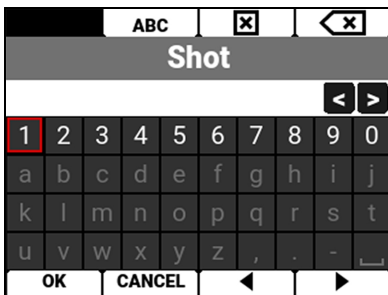

## TAKE

Use Take to enter the number of the take.

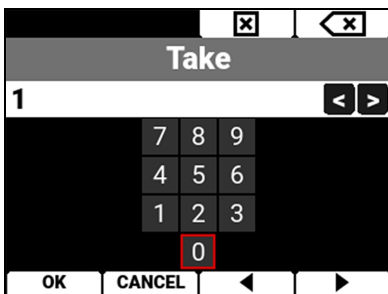



## PRODUCTION

Use Production to enter the name of the production.

The screenshot shows a menu titled "Production" with a text input field above a numeric keypad. The keypad has rows for numbers 1-0, letters a-j, k-t, and u-z with punctuation. The number "1" is highlighted with a red box. At the top, there are "ABC", "X", and a back arrow icon. At the bottom, there are "OK", "CANCEL", and left/right arrow icons.

## DIRECTOR

Use Director to enter the name of the director.

The screenshot shows a menu titled "Director" with a text input field above a numeric keypad. The keypad has rows for numbers 1-0, letters a-j, k-t, and u-z with punctuation. The number "1" is highlighted with a red box. At the top, there are "ABC", "X", and a back arrow icon. At the bottom, there are "OK", "CANCEL", and left/right arrow icons.

## DOP

Use DoP to enter the name of the director of photography.

The screenshot shows a menu titled "DoP" with a text input field above a numeric keypad. The keypad has rows for numbers 1-0, letters a-j, k-t, and u-z with punctuation. The number "1" is highlighted with a red box. At the top, there are "ABC", "X", and a back arrow icon. At the bottom, there are "OK", "CANCEL", and left/right arrow icons.

## UNIT

Use Unit to enter the name of the production unit.

The screenshot shows a menu titled "Unit" with a text input field containing the number "1" above a numeric keypad. The keypad has rows for numbers 1-0, letters a-j, k-t, and u-z with punctuation. The number "1" is highlighted with a red box. At the top, there are "ABC", "X", and a back arrow icon. At the bottom, there are "OK", "CANCEL", and left/right arrow icons.

## AUDIO / TC MENU

The Audio / TC menu contains the settings you use to configure your camera audio and Timecode.

From the camera LCD menu, navigate to Audio / TC and press SEL:

| Menu             |   | Menu > Audio / TC            |                 |
|------------------|---|------------------------------|-----------------|
| Image / LUT      | > | Audio Source                 | Internal Micr ▼ |
| Project Settings | > | Internal Microphone (Ch 1/2) | >               |
| Audio / TC       | > | External (Ch 3/4)            | >               |
| Monitoring       | > | Headphone                    | >               |
| Media            | > | Timecode Source              | Internal T... ▼ |

Use the Audio / TC menu to configure the audio and Timecode settings for the camera:

| ITEM                         | DETAILS                                     |
|------------------------------|---|
| Audio Source                 | Audio input source                          |
| Internal Microphone (Ch 1/2) | Left and right internal microphone levels   |
| External (Ch 3/4)            | Left and right external audio levels        |
| Headphone                    | Headphone volume level                      |
| Timecode Source              | Timecode source                             |
| Auto Jam                     | Button to enable auto-jamming TOD Timecode  |
| Jam Timecode to TOD          | Button to jam Timecode to time-of-day (TOD) |
| Timecode Display Mode        | Timecode to display                         |

## AUDIO DETAILS

The camera is equipped with two integrated microphones suitable for scratch-track audio (Ch 1 and 2), and it is equipped with a 5-Pin LEMO audio connector that accepts 2-channel audio, Line, Mic, and +48V Phantom Power for external audio (Ch 3 and 4).

You can link the gain for the two internal channels together and you can link the two external channels together. This allows you to adjust the two internal (or external) channels together as one.

You can record audio from the internal microphones, from the external audio connector (2-channel recording), or from internal and external sources combined as 24-bit 48 kHz uncompressed audio tracks.

You can adjust the external audio by using the appropriate camera gain-settings (-52.5 dB to 36.0 dB). The default camera gain setting is 1 dB.

The camera's audio data is synchronized with video and timecode, and it is embedded in the R3D file. You can export the audio data as separate audio files by using REDCINE-X PRO, if needed. The camera also embeds the audio in the SDI output.

You can monitor the audio during recording and playback by using the equipped 3.5 mm stereo headphone port.

## VARISPEED AUDIO

This camera has the ability to record audio when the camera's Recording Frame Rate is set to a higher speed than the Project Time Base setting (Varispeed mode).

**NOTE:** The camera records the audio as a separate WAV file and stores it in the clip's RDC folder on the media drive.

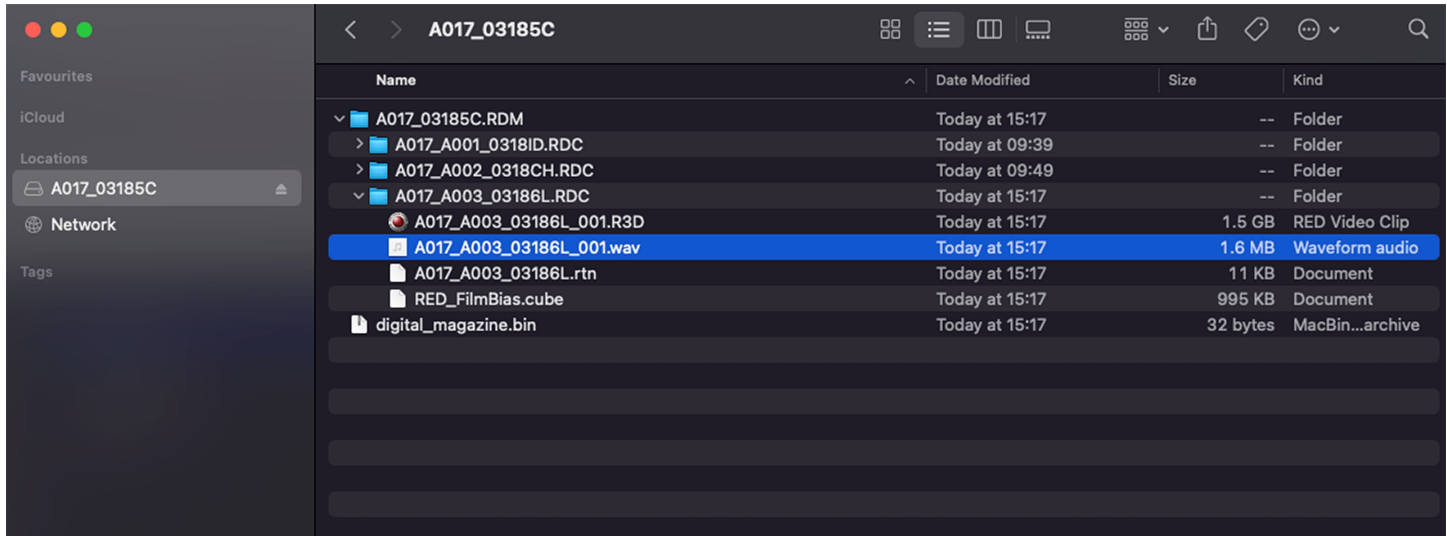

## TIMECODE DETAILS

Timecode provides a mechanism to reference frames from the camera's recorded clips to external devices, such as other cameras or audio recorders. Some devices can also gather additional data such as, lens metadata, or camera orientation, which Timecode can later use for merging the data back together in post-processing.

The camera provides two separate Timecode formats:

- **Time Of Day (TOD)** - The camera records the time of day as the Timecode for each clip
- **Edgecode** - The camera records elapsed time as the Timecode for each clip. The time is reset to 01:00:00 when a new media card is inserted in the camera. All of the clips on the media will have a continuous Timecode track. However, each new media card will default to a Timecode track starting at 01:00:00. Edgecode is equivalent to RUN RECORD as used on broadcast cameras. You can change the Edgecode to begin at any desired time by using the Media Format menu (refer to [Edgecode](#)).

The camera synchronizes (jams) the TOD Timecode to an external Timecode generator (when one is connected to the camera) or it jams the Timecode to its internal real-time clock.

When using Internal TOD, a jam between the running timecode and a real time clock is required. The time at which this jam occurs will have an effect on the overall timecode drift over a 24-hour period due to the nature of non-drop-frame (NDF) timecode. By enabling Auto-Jam, the camera automatically jams its timecode, ensuring repeatable drift across multiple cameras and days.

When Auto Jam is disabled, you can manually pick the instant in which you want to jam timecode to the real time clock.

The camera stores TOD and Edge Timecode in the R3D file. You can select which one you want to display on the side LCD (refer to [Timecode Display Mode](#)).

## AUDIO SOURCE

Use the Audio Source settings to select the audio input source.

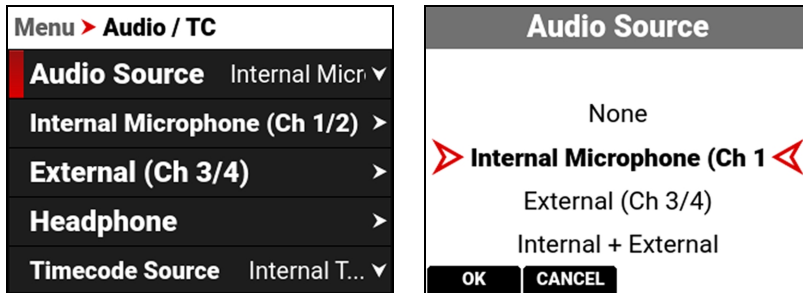

The audio input sources include:

- None
- Internal Microphone (Ch 1/2) - enables the **Internal Microphone (Ch 1/2)** menu (default)
- External (Ch 3/4) - enables the **External (Ch 3/4)** menu
- Internal + External - enables all audio sources

**NOTE:** The headphones can only monitor the internal microphone channels (Ch 1 and 2) or the external audio channels (Ch 3 and 4).

## INTERNAL MICROPHONE (CH 1/2)

Use the Internal Microphone (Ch 1/2) settings to set the left and right internal audio levels (channels 1 and 2). This menu is only enabled when the Audio Source is set to Internal Microphone or Internal + External. Internal audio is intended as scratch audio quality only.

**NOTE:** When the Recording Frame Rate and Project Time Code settings are different, varisped audio is recorded (refer to **Audio / TC Menu**).

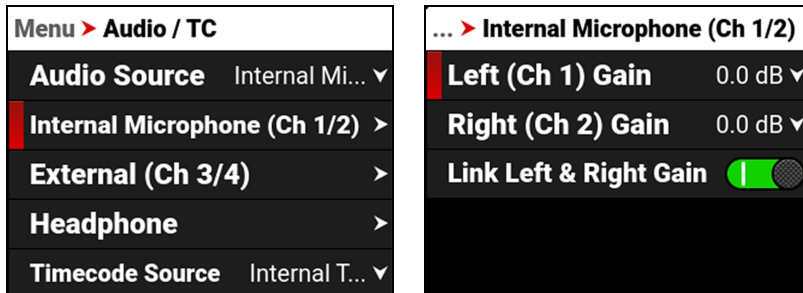

The Internal Microphone is represented as Channels 1 and 2 on the Home Page and on the Audio Channels 1/2 Page VU Meters (refer to **LCD** for more information). The left channel is channel 1 and the right channel is channel 2.

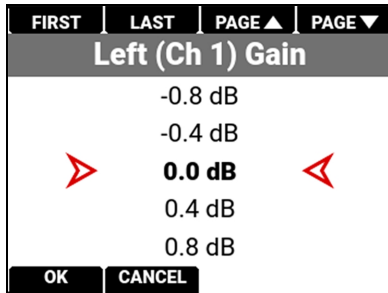

You can adjust the internal audio levels for left and right from -52.5 dB to 36.0 dB.

The default setting is 0 dB.

When you enable Link Left & Right Gain, the channels are linked together and adjusted as one.

## EXTERNAL (CH 3/4)

Use the External audio settings to set the left and right external audio levels. This menu is only enabled when the **Audio Source** is set to External (Ch 3/4) or Internal + External.

**NOTE:** When the Recording Frame Rate and Project Time Code settings are different, varispeed audio is recorded (refer to **Audio / TC Menu**).

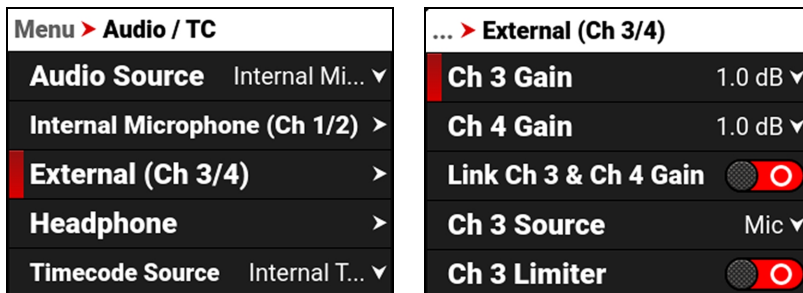

The External audio is represented as Channels 3 and 4 on the Home Page and on the Audio Channels 3/4 Page VU Meters (refer to **LCD** for more information). The left channel is channel 3 and the right channel is channel 4.

## GAIN

You can adjust the external audio gain levels for channels 3 and 4 from -8.0 dB to 34.0 dB.

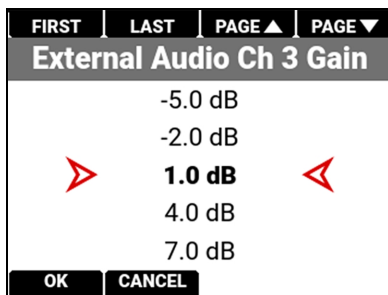

The default setting is 1.0 dB.

When you enable Link Channel 3 and Channel 4 Gain, the channels are linked together and adjusted as one.

## SOURCE

Use Source to select the type of input connected to external audio channel 3 and 4 ports.

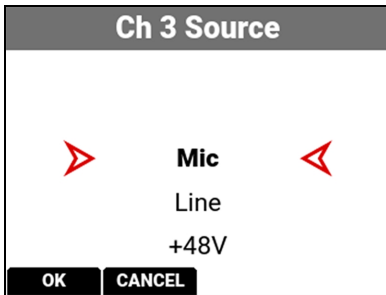

You can select microphone, line, or +48V phantom power. The default setting is microphone (Mic).

## LIMITER

When enabled, use the limiter to place a limit past which the audio level for channels 3 and 4 cannot exceed.

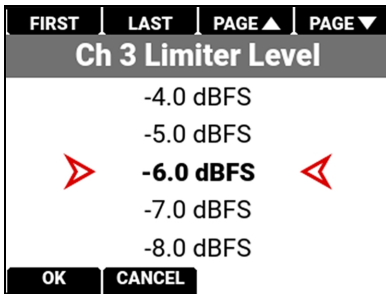

You can select from -2.0 to -12.0 Decibel Full Scale (dBFS) as the limit. The default limit is -6.0 dBFS.

## HEADPHONE

Use the Headphone settings to enable the headphone jack and to adjust the headphone volume.

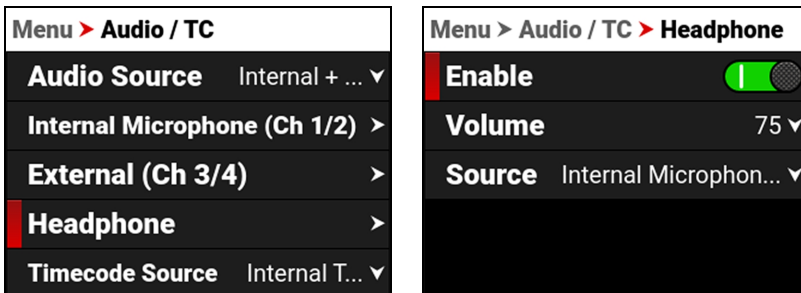

You can enable and disable the headphone audio jack by pressing SEL to toggle Enable to the right (green / enabled) and to the left (red / disabled).



## VOLUME

You can adjust the headphone volume from 0 to 100.

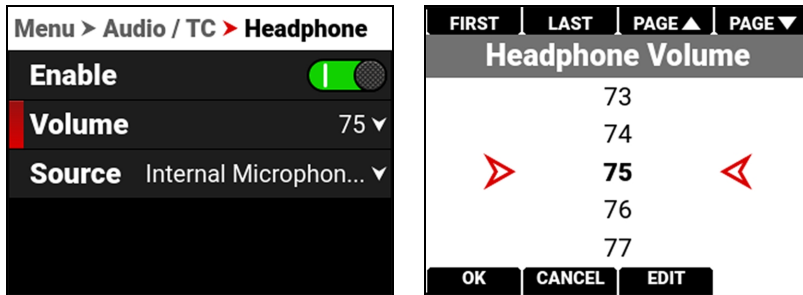

## SOURCE

When the Audio Source is set to Internal + External, you can use Source to select the audio source you want to monitor with the headphones.

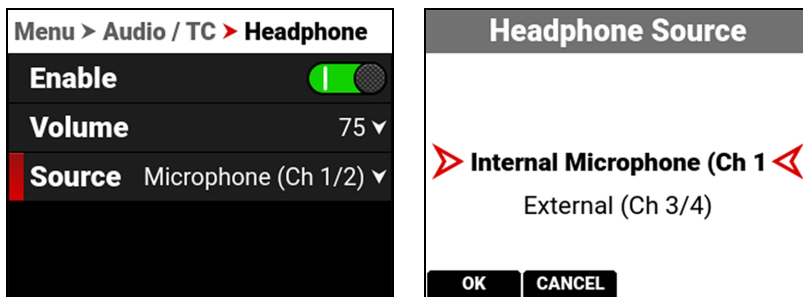

You can select the internal microphone channels 1 and 2, or you can select the external channels 3 and 4. The default setting is the internal microphone channels 1 and 2.

## TIMECODE SOURCE

Use Timecode source to configure the Timecode source the camera applies to the recordings.

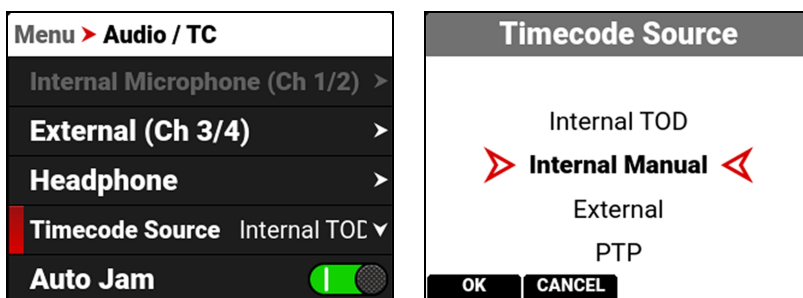

You can select the following Timecode sources:

- Internal Time of Day (TOD)
- Internal Manual
- External
- Precision Time Protocol (PTP)

## INTERNAL TOD

Use Internal Time of Day (TOD) to JAM to the camera's internal Timecode generator. When using Internal TOD, a jam between the running timecode and a real time clock is required. The time at which this jam occurs will have an effect on the overall timecode drift over a 24-hour period due to the nature of non-drop-frame (NDF) timecode.

By enabling Auto-Jam, the camera automatically jams its timecode, ensuring repeatable drift across multiple cameras and days. When Auto Jam is disabled, you can manually pick the instant in which you want to jam timecode to the real time clock.

## INTERNAL MANUAL

Use Internal Manual to JAM to the camera's internal Timecode generator and edit the Timecode starting number.

Select Manual Timecode OK to open the JAM and editing options:

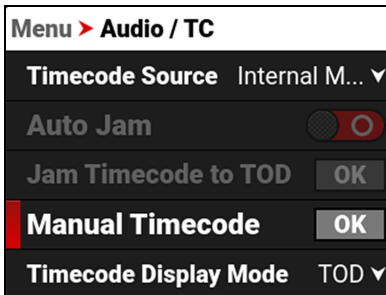

Select JAM to jam to the internal Timecode or select Manual Timecode to open the editing screen:

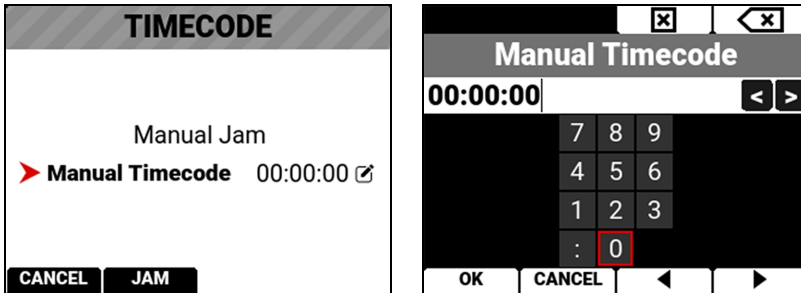

Enter the desired Timecode number and select OK.

Select JAM to jam to the edited Timecode number.

## EXTERNAL

Use External to connect an external Timecode generator to the 5-Pin 0B Timecode port (refer to [Camera Body](#) and [Timecode Port](#) for more information).

## PRECISION TIME PROTOCOL (PTP)

Use PTP to connect an external PTP clock to the Extension Port (refer to [Camera Body](#) and [Extension Port](#) for more information).

Precision Time Protocol (SMPTE 2059-1) is a network-based synchronization method which when configured using a USB-C to Ethernet adapter offers a level of precision that supports frame-accurate camera synchronization over IP. PTP in the V-RAPTOR camera body only offers frame-level precision and therefore cannot be used for sensor scan synchronization. PTP Timecode can be sent over USB-C through an Ethernet adapter.



## TIMECODE DISPLAY MODE

Use Timecode Display Mode to configure the Timecode display type that the camera applies to the recordings.

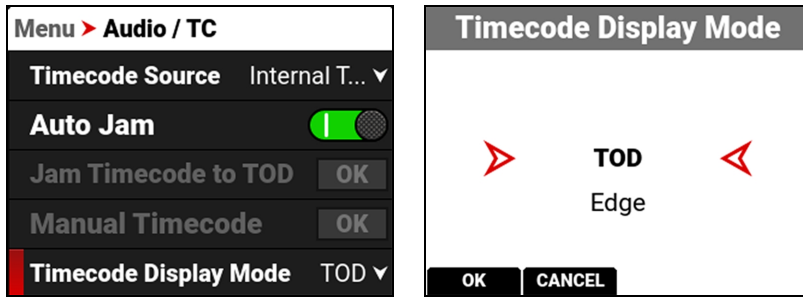

You can set the Timecode Display Mode as Time of Day (TOD) or Edge.

### TOD DISPLAY MODE

Time of Day (TOD) display mode displays the Timecode as the time of day that the frame was recorded.

### EDGE DISPLAY MODE

Edge display mode displays the Timecode as the sequential recording time that has elapsed starting with the first frame.

## MONITORING MENU

The Monitoring menu contains the settings you use to configure your camera monitoring options.

From the LCD menu, navigate to Monitoring and press SEL:

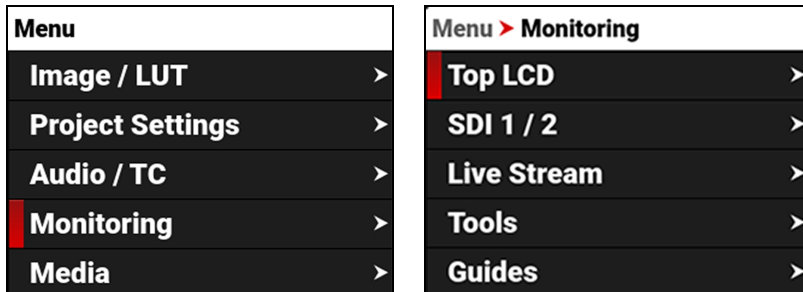

Use the Monitoring menu to configure the monitoring settings:

| ITEM        | DETAILS   |
|-------------|---|
| Top LCD     | Monitoring tools for the top LCD  |
| SDI 1 / 2   | SDI port resolution, frequency, look, guides, tools, overlay, and overlay mode                  |
| Live Stream | Enable or disable Wi-Fi live streaming  |
| Tools       | Various monitoring tools including <b>False Color</b> , <b>Peaking</b> , and <b>Zebra Modes</b> |
| Guides      | Frame guides and a center guide   |

## TOP LCD

The Top LCD menu provides access to the top LCD features. This menu is only visible when the optional DSMC3™ RED Touch 7.0" LCD is attached to the camera (refer to [DSMC3™ RED® Touch 7.0" LCD](#)).

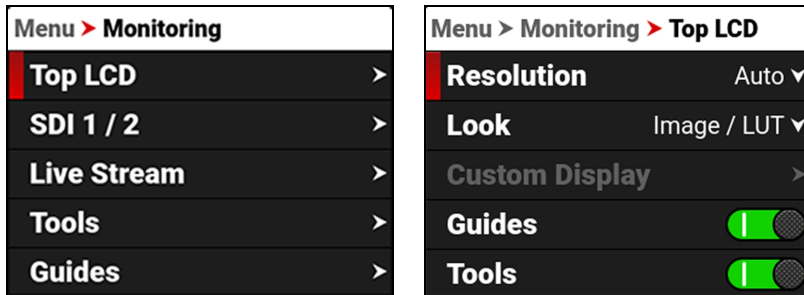

The Top LCD settings you can configure include:

| ITEM                             | DETAILS  |
|----------------------------------|--|
| <a href="#">Resolution</a>       | Select the monitor resolution                                    |
| <a href="#">Look</a>             | Set the look of the monitor between RWG / Log3G10 or Image / LUT |
| <a href="#">Custom Display</a>   | Select the gamma displayed on the monitor                        |
| <a href="#">Guides</a>           | Enable or disable the monitor guides                             |
| <a href="#">Tools</a>            | Enable or disable the monitor tools                              |
| <a href="#">Magnify</a>          | Magnify the monitor image  |
| <a href="#">Magnify Position</a> | Select the position of the original image to magnify             |
| <a href="#">Flip / Mirror</a>    | Flip and mirror the top LCD display                              |

## RESOLUTION

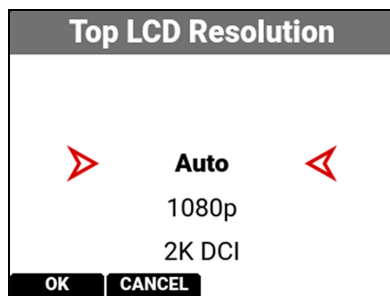

You can select the resolution of the Top LCD.

The selections include:

- Auto (default)
- 1080p
- 2K DCI

## LOOK

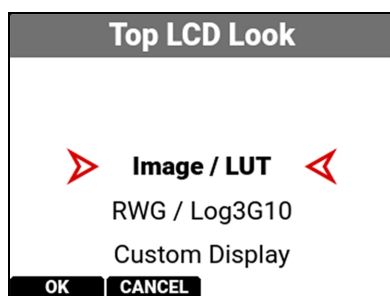

You can select the look of the image preview signal sent to the Top LCD.

The selections include:

- Image / LUT (default)
- REDWideGamutRGB / Log3G10
- Custom Display (enables the Custom Display menu)

## CUSTOM DISPLAY

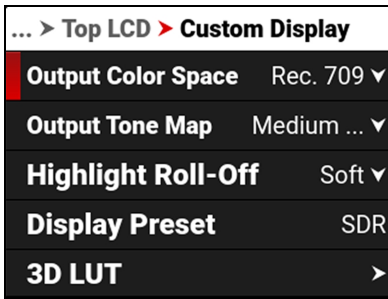

Use Custom Display to select the Top LCD's Image/LUT settings.

Refer to [Image / LUT Menu](#) for more information about the Image/LUT settings and menus.

## GUIDES

Use Guides to enable or disable the viewing of guides. Press SEL to toggle between enabled (default) and disabled.



## TOOLS

Use Tools to enable or disable the viewing of tools. Press SEL to toggle between enabled (default) and disabled.



## MAGNIFY

Use Magnify to enable or disable monitor magnification. Press SEL to toggle between enabled and disabled (default).



## MAGNIFY POSITION

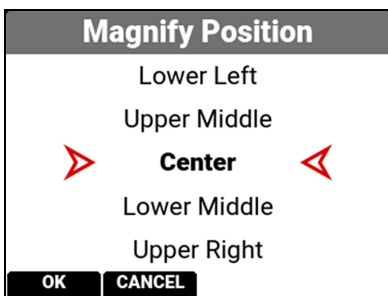

Use Magnify Position to globally select the area of the image you want to magnify.

The selections include:

- Left
- Upper Middle
- Upper Right
- Upper Left
- Center (default)
- Lower Right
- Lower Left
- Lower Middle
- Right

## FLIP / MIRROR

Use Flip / Mirror to enable or disable the flipped mirrored orientation of the Top LCD. Press SEL to toggle between enabled and disabled (default).



## SDI 1 / 2

Use SDI 1 / 2 to configure the settings on SDI ports 1 and 2.

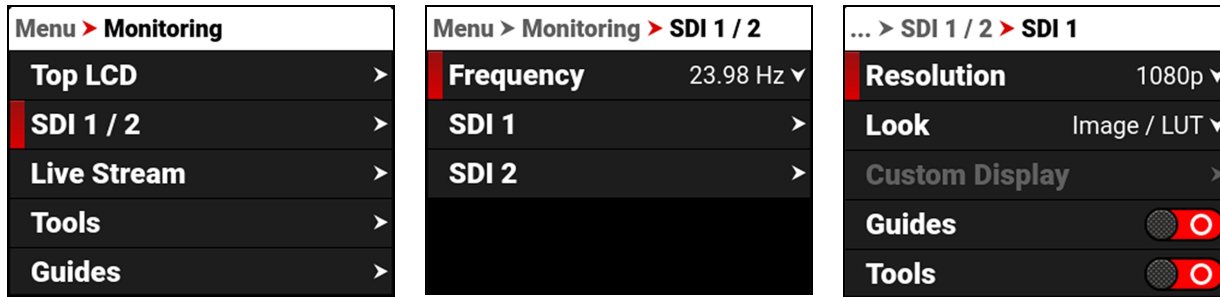

You can quickly configure SDI 2 to match SDI 1 by selecting Mirror SDI 1 on the SDI 2 menu:

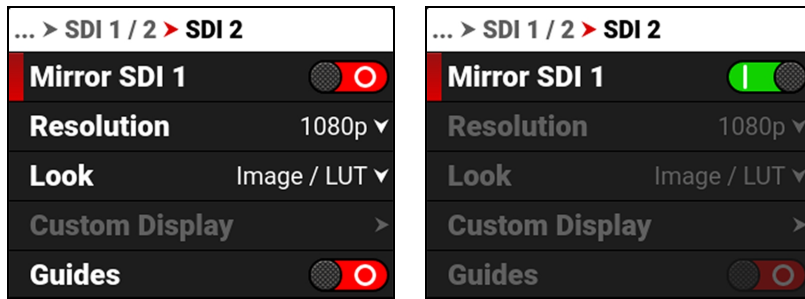

The SDI port settings you can configure include:

| ITEM                      | DETAILS  |
|---------------------------|--|
| Frequency                 | Select the SDI port frequency  |
| Resolution                | Select the SDI port resolution   |
| Look                      | Set the look of the monitor to RWG/Log3G10, Image/LUT, or Custom Display   |
| Custom Display            | Configure the look of the monitor independently of other monitor pipelines |
| Guides                    | Enable or disable the monitor guides                                       |
| Tools                     | Enable or disable the monitor tools  |
| Magnify                   | Magnify the monitor image  |
| Magnify Position (Global) | Select the area of the image to magnify                                    |
| Overlay                   | Enable or disable the monitor overlay                                      |
| Overlay Mode              | Select the overlay type  |
| Overlay Opacity           | Select the opacity of the overlay  |
| Flip / Mirror             | Flip and mirror the image output to the monitor                            |

**WARNING:** Under certain circumstances, it is possible for an SDI connector to incur damage when connected to an accessory and powered without using shielded cables. RED recommends only using high quality, shielded BNC cables that are rated for 12G-SDI signals and only using shielded power cables for powering SDI accessories.

Make sure power is connected to the SDI accessory at all times before you connect the BNC to the camera. Ungrounded power from SDI accessories can damage the camera's SDI port. To avoid this possible damage, attach the power source to the accessory before attaching it to the BNC cable. When using RED Approved Third Party battery plates, unplug the BNC cable prior to hot swapping.

When possible, avoid using P-Tap (also known as D-Tap) cables to power accessories. To avoid damage when using P-Tap/D-Tap, it's imperative that the connect/disconnect sequence (below) is followed precisely.

## BNC ATTACHMENT INSTRUCTIONS

When attaching SDI accessories:

1. Connect a power source to the SDI accessory; power on the SDI accessory.
2. Ensure a power source is connected to the camera. This ensures both are grounded prior to connecting the BNC. The camera's power state does not have an impact on SDI attachment sequence.
3. Connect the BNC cable to the accessory, then to the camera.

When detaching an accessory mounted to an SDI output, ensure that you remove the BNC connection to the camera before removing power to the SDI device:

1. Shutdown the SDI accessory.
2. Disconnect the BNC cable from the camera.
3. Disconnect the power source from the SDI accessory.

When you need to swap out a battery on an accessory mounted to the camera's SDI port, you must:

1. Shutdown the SDI accessory.
2. Disconnect the BNC cable from the camera.
3. Replace the battery on the SDI accessory.
4. Connect the BNC cable to the camera.
5. Power on the SDI accessory.

For more information about SDI safety, refer to [Preventing Damage to SDI Outputs](#).

## FREQUENCY

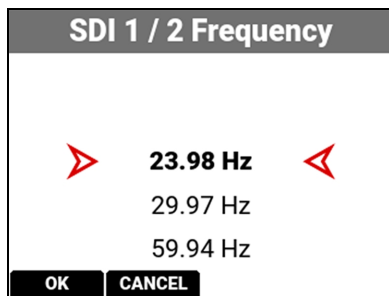

Use Frequency to select one of the following SDI port frequency settings:

- 23.98 Hz
- 29.97 Hz
- 59.94 Hz

The camera displays different choices depending on which Project Time Base you have selected.

## RESOLUTION

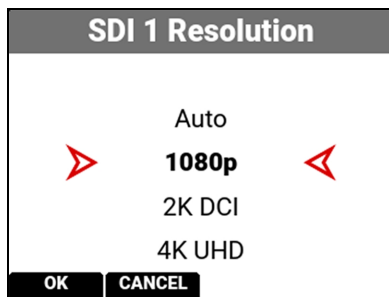

Use resolution to select one of the following SDI port resolution settings:

- Auto
- 1080p (default)
- 2K DCI
- 4K UHD
- 4K DCI

The resolution selected here controls the SDI output resolution of the preview page.

## SCALING PREVIEW

When monitoring in 1080p or 4K UHD while capturing in a 17:9 format, the entire 17:9 image will be down-scaled to the 16:9 aspect ratio of 1080p or 4K UHD. Small black bars will only appear on the top and bottom of the frame in the monitor path and not on the recorded image.

## LOOK

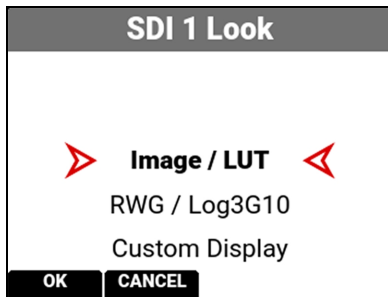

You can select the look of the image preview signal sent to the SDI port.

The selections include:

- Image / LUT (default)
- REDWideGamutRGB / Log3G10
- Custom Display (enables the Custom Display menu)

## CUSTOM DISPLAY

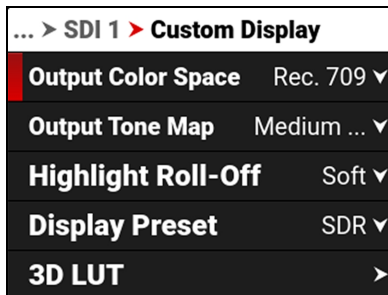

Use Custom Display to configure the SDI independently of the camera's Image / LUT settings or other monitor output configurations.

Refer to [Image / LUT Menu](#) for more information about how to use the Image/LUT settings and menus.

## GUIDES

Use Guides to enable or disable the viewing of guides. You can enable and disable guides by pressing SEL to toggle Guides to the right (green / enabled) and to the left (red / disabled).



## TOOLS

Use Tools to enable or disable the viewing of tools. You can enable and disable tools by pressing SEL to toggle Tools to the right (green / enabled) and to the left (red / disabled).



## MAGNIFY

Use Magnify to enable or disable the magnification of the output image. You can enable and disable magnification by pressing SEL to toggle Magnify to the right (green / enabled) and to the left (red / disabled).



## MAGNIFY POSITION (GLOBAL)

Use Magnify Position to select the area of the output image to magnify for all monitor outputs.

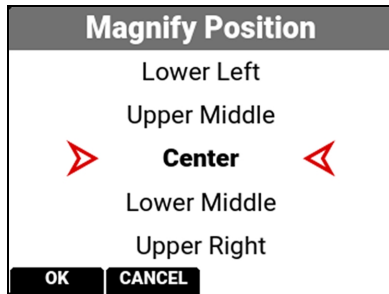

Use Magnify Position to globally select the area of the image you want to magnify.

The selections include:

- Left
- Upper Middle
- Upper Right
- Upper Left
- Center (default)
- Lower Right
- Lower Left
- Lower Middle
- Right

## OVERLAY

Use Overlay to enable or disable the viewing of the overlay. You can enable and disable the overlay by pressing SEL to toggle Overlay to the right (green / enabled) and to the left (red / disabled).



## OVERLAY MODE

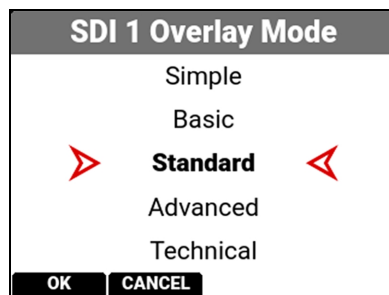

Use Overlay Mode to select one of the following SDI port overlay modes:

- Simple - Minimal image information is displayed (refer to **Simple Mode**)
- Basic - Simple plus time sensitive media and battery information (refer to **Basic Mode**)
- Standard - Industry standard image and camera details are displayed (refer to **Standard Mode**)
- Advanced - Standard plus exposure and audio meters (refer to **Advanced Mode**)
- Technical - Advanced plus lens focus distance and monitor look status (refer to **Technical Mode**)

## SIMPLE MODE



Simple mode displays the clip name and the current Timecode. When the camera is recording, the Timecode turns red, and a red dot appears in the top right corner.





## BASIC MODE



Basic mode displays the following:

- Clip Name
- CFexpress Time Remaining (at the current settings)
- Timecode
- Battery percentage remaining (at the current settings)
- DC-IN

When the camera is recording, the Timecode turns red, and a red dot appears in the top right corner.

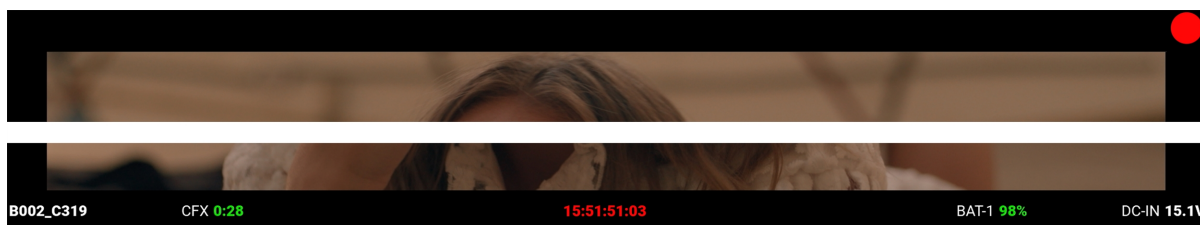

## STANDARD MODE



Standard mode displays the following:

| TOP  | BOTTOM   |
|--|--|
| <ul style="list-style-type: none"> <li>• Camera ID</li> <li>• Recording Frame Rate</li> <li>• f-Stop</li> <li>• Focus Length</li> <li>• Shutter Angle</li> <li>• ISO</li> <li>• White Balance</li> </ul> | <ul style="list-style-type: none"> <li>• Clip Name</li> <li>• CFexpress Time Remaining</li> <li>• Format, File Type, Rate</li> <li>• Battery</li> <li>• DC-IN</li> <li>• Timecode</li> </ul> |

Lens items such as Focal Length and f-Stop will adaptively display depending on whether the lens data is available. When the camera is recording, the Timecode turns red, and a red dot appears in the top right corner.



## ADVANCED MODE



Advanced mode displays the following:

### TOP

- Camera Number
- Recording Frame Rate
- f-Stop
- Focus Length
- Shutter Angle
- ISO
- White Balance

### BOTTOM

- Clip Name
- Exposure Meter
- Histogram
- CFexpress Time Remaining
- Temperature / Exposure Calibration
- Timecode, Genlock, Synch
- DC-In, Battery
- Format, File Type, Rate
- VU Meter
- Timecode

When the camera is recording, the Timecode turns red, and a red dot appears in the top right corner.



## TECHNICAL MODE



Technical mode displays the following:

### TOP

- Camera ID
- Recording Frame Rate
- f-Stop
- Focus Length
- Shutter Angle
- ISO
- White Balance
- SDI Port
- Look

### BOTTOM

- Exposure Meter
- Histogram
- Clip Name
- CFexpress Time Remaining
- Temperature / Exposure Calibration
- Timecode, Genlock, Synch
- Camera Name
- DC-In, Battery
- Format, File Type, Rate
- Timecode
- VU Meter

When the camera is recording, the Timecode turns red, and a red dot appears in the top right corner.

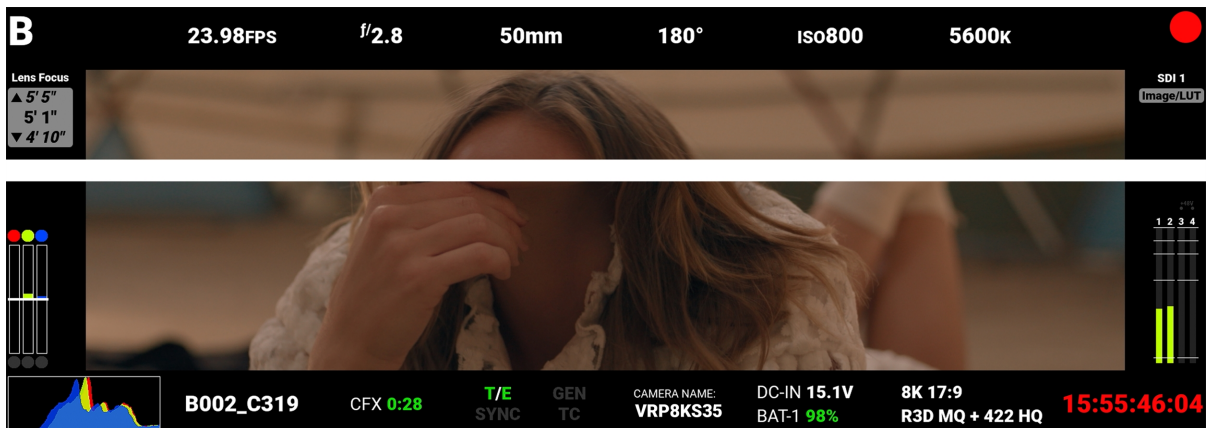

## OVERLAY OPACITY

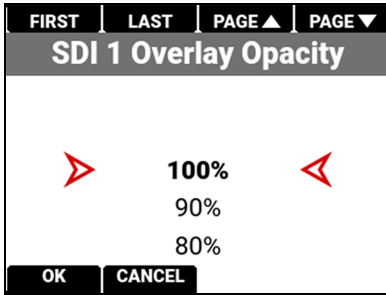

Use Overlay Opacity to select the percentage of opacity you want the overlay to display on the SDI output.

The opacity values the camera can display are between 100% and 0%.

## FLIP / MIRROR

Use Flip / Mirror to enable or disable the flipped mirrored orientation of the SDI output. Press SEL to toggle between enabled and disabled (default).



## SDI PORT DESCRIPTION

The Serial Digital Interface (SDI) ports allow the camera to deliver 12 Gbps of image bandwidth with greater resolution, frame rates, and color fidelity. These ports allow you to use a single BNC cable solution ideal for 4Kp60 format. The output signal bit depth is 10-bit 4:2:2.

**WARNING:** Under certain circumstances, it is possible for an SDI connector to incur damage when connected to an accessory and powered without using shielded cables. RED recommends only using high quality, shielded BNC cables that are rated for 12G-SDI signals and only using shielded power cables for powering SDI accessories.

Make sure power is connected to the SDI accessory at all times before you connect the BNC to the camera. Ungrounded power from SDI accessories can damage the camera's SDI port. To avoid this possible damage, attach the power source to the accessory before attaching it to the BNC cable. When using RED Approved Third Party battery plates, unplug the BNC cable prior to hot swapping.

When possible, avoid using P-Tap (also known as D-Tap) cables to power accessories. To avoid damage when using P-Tap/D-Tap, it's imperative that the connect/disconnect sequence (below) is followed precisely.

## BNC ATTACHMENT INSTRUCTIONS

When attaching SDI accessories:

1. Connect a power source to the SDI accessory; power on the SDI accessory.
2. Ensure a power source is connected to the camera. This ensures both are grounded prior to connecting the BNC. The camera's power state does not have an impact on SDI attachment sequence.
3. Connect the BNC cable to the accessory, then to the camera.

When detaching an accessory mounted to an SDI output, ensure that you remove the BNC connection to the camera before removing power to the SDI device:

1. Shutdown the SDI accessory.
2. Disconnect the BNC cable from the camera.
3. Disconnect the power source from the SDI accessory.

When you need to swap out a battery on an accessory mounted to the camera's SDI port, you must:

1. Shutdown the SDI accessory.
2. Disconnect the BNC cable from the camera.
3. Replace the battery on the SDI accessory.
4. Connect the BNC cable to the camera.

5. Power on the SDI accessory.

For more information about SDI safety, refer to [Preventing Damage to SDI Outputs](#).



For more information about SDI, refer to:

- [12G-SDI \(SDI-1 & SDI-2\)](#)
- The SDI standard: SMPTE (Society of Motion Picture and Television Engineers) standard SMPTE ST-2082

## LIVE STREAM

Use Live Stream to enable or disable live streaming over Wi-Fi and USB. This is one of the methods you can use to connect to the **RED Control App**. The live stream output is 1080p.

**NOTE:** When live streaming, select 5 GHz as the Wi-Fi band (refer to **Ad-Hoc**).

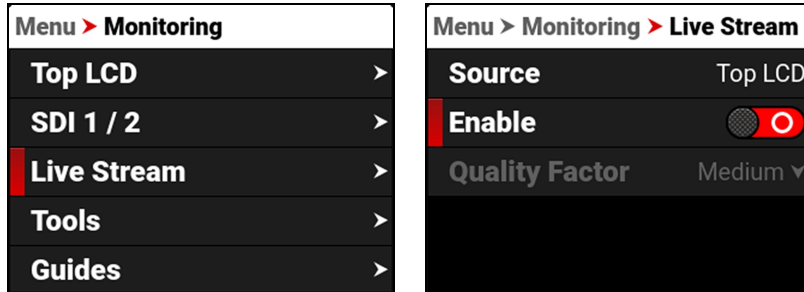

## SOURCE

Source displays the source of the Live Stream image. Live stream displays the looks, tools, and magnification enabled for that source.

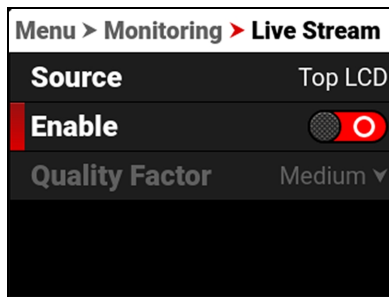

## ENABLE

Use Enable to enable or disable the Live Stream feature.



## QUALITY FACTOR

Use Quality Factor, when Live Streaming is enabled, to control the video quality the camera's output streams. Lower quality can stream over a longer distance.

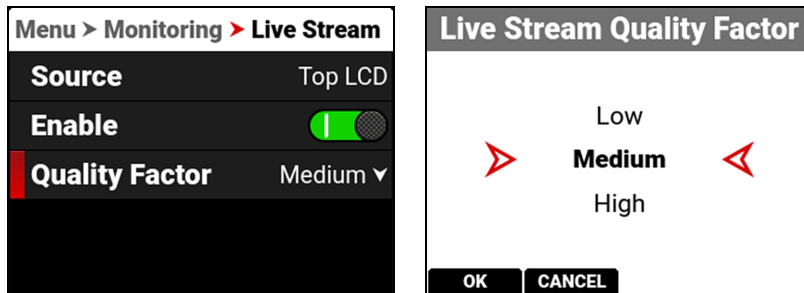

## TOOLS

The Tools menu provides access to the monitoring tools you use to monitor image exposure and focus.

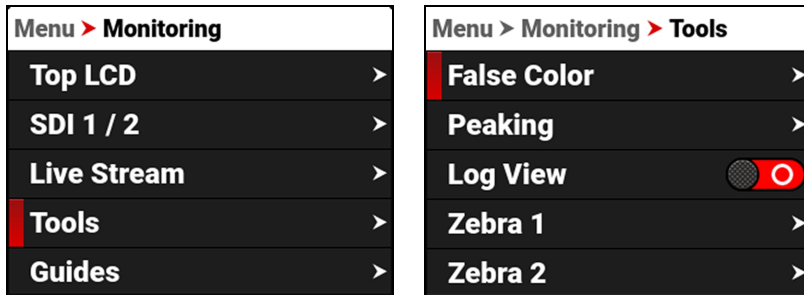

The monitoring tools that you can use include:

| ITEM        | DETAILS   |
|-------------|---|
| False Color | Enable and configure the False Color Exposure Mode and the False Color Video Mode |
| Peaking     | Enable and configure focus indicating modes                                       |
| Log View    | Enable or Disable Log View  |
| Zebra 1     | Enable and configure Zebra 1 settings   |
| Zebra 2     | Enable and configure Zebra 2 settings   |

## FALSE COLOR

Use False Color to configure the False Color tool settings.

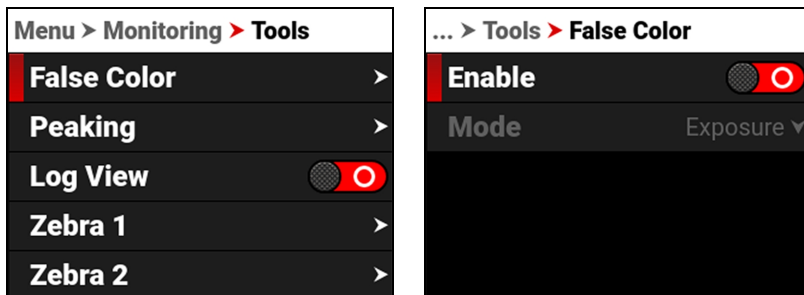

The False Color tool settings you can configure include:

| ITEM             | DETAILS                                      |
|------------------|--|
| Enable           | Enable or disable the False Color tool modes |
| False Color Mode | Select the False Color tool mode             |

## ENABLE

Use Enable to enable or disable the False Color tool.





## FALSE COLOR MODE

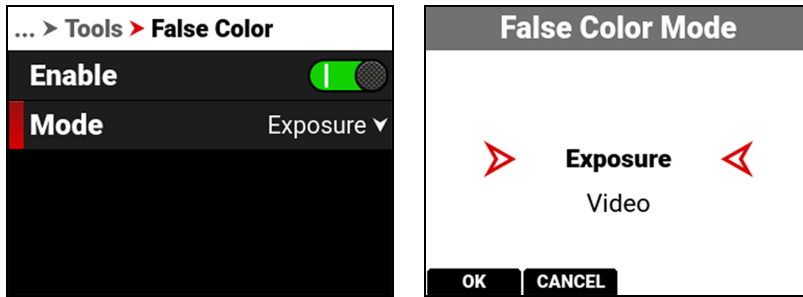

False Color Modes include:

| ITEM                      | DETAILS  |
|---------------------------|--|
| False Color Exposure Mode | Use false colors to determine an optimal balance between overexposure and underexposure. |
| False Color Video Mode    | Access scene exposure in varying light without relying on the LCD image brightness.      |

**NOTE:** False Color modes display on video recorded through SDI to an external recorder when the Tools are enabled in the Monitor menu. When recording through SDI, use False Color modes only to help determine scene exposure settings, and then disable the mode before recording.

## FALSE COLOR EXPOSURE MODE

When this monitoring **False Color** mode is activated, most of the tonal range will appear in monochrome.

The Exposure Mode is able to indicate exactly where middle gray is falling, and indicate which highlights or shadows are problematic in the logarithmic representation of the image. Exposure mode is judging the exposure after ISO and White Balance adjustments are made, and before any sort of LUT or transform is applied to the Log3G10 image.

## RED FALSE COLOR OVERLAY

When the False Color Mode overlays the color red within the subject of interest, or anywhere except bright lights and direct reflections, then the image is likely overexposed. When the False Color Mode does not overlay the color red on the image, then the exposure is likely okay for the selected ISO.

## PURPLE FALSE COLOR OVERLAY

When the False Color Mode overlays the color purple on key image detail that is not located in the shadows, then the scene is likely underexposed. When the False Color Mode does not overlay the color purple on the image, then the exposure is likely okay for the selected ISO.

For more information, refer to **Exposure** in the How To section.

## FALSE COLOR VIDEO MODE

**NOTE:** For best results, Video Mode should be viewed at or above ISO 800.

Video Mode displays a color overlay that indicates the video level of the RGB monitor path (calibrated to the SMPTE test signal).

The colors used are based on the RGB levels of the video out signal (that is, the “cooked” look, and not RAW data). The camera's RGB settings can change the appearance of the Video Mode colors.

The Video Mode colors represent the following IRE values (at all other values, the desaturated image represents the luminance value of the ISO adjusted image):

- Purple: IRE 0–4
- Blue: IRE 5
- Teal: IRE 10–12
- Green: IRE 41–48
- Pink: IRE 61–70
- Straw: IRE 92–93
- Yellow: IRE 94–95
- Orange: IRE 96–98
- Red: IRE 99–100

For more information, refer to [Exposure](#) in the How To section.



Green is where you will want 18% gray, Pink is typically the brightness of Caucasian skin tones, Straw, Yellow, and Orange are strong highlights and increasingly closer to white, Teal is deep shadows and Blue is on the verge of becoming untextured black. In general, Pink and Green are most helpful when calibrating based on a known reference, whereas the other colors indicate the extremes of a tonal range.

A potential disadvantage of False Color Video mode is that all the false colors can distract from the underlying preview. Many prefer to use this mode only during initial set-up, and then they use [False Color Exposure Mode](#) under a wider range of scenarios.

## IN PRACTICE

In [False Color Exposure Mode](#), use the purple and red indicators to adjust your lighting or lens aperture. Use this strategy to achieve an optimal balance between clipping from overexposure and image noise from underexposure. With most scenes, you can often have a surprising range of exposure latitude before excessive red or purple indicators begin to appear.

If necessary, use False Color Video mode or [Zebra Modes](#) to fine-tune how the scene will appear over SDI, or use it to adjust your suggested look when sending footage for post-production.

The Zebra and Video modes are also an objective way to assess the scene exposure under varying ambient light without relying on the monitor image to evaluate brightness.

## PEAKING

The Peaking tools display contrast, outlines, or colors to assist with focusing.

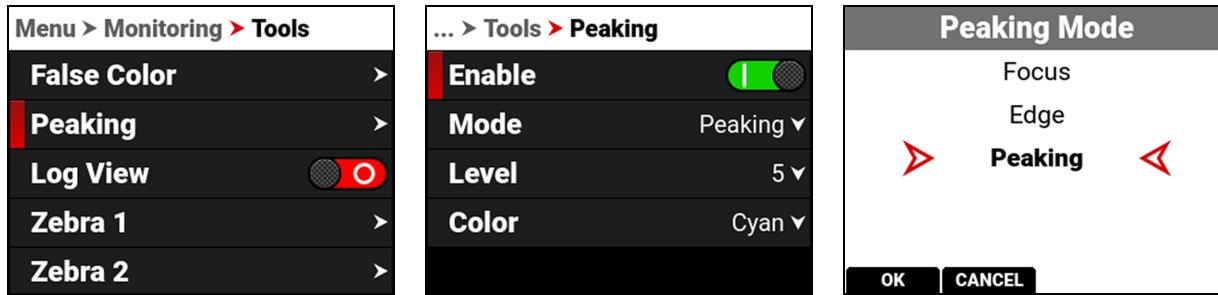

The Peaking modes you can use include:

| ITEM    | DETAILS   |
|---------|---|
| Focus   | Use enhanced contrast and edges for focusing          |
| Edge    | Show outlines of focused objects                      |
| Peaking | Select a colored overlay to indicate objects in focus |

### FOCUS PEAKING MODE

Focus Peaking mode emphasizes contrast and edges in the image without changing the brightness or the image content. This mode makes it easier to judge focus. Adjust the zoom and focus to easily see which objects are coming into focus.

### EDGE PEAKING MODE

When you enable Edge Peaking mode, the display shows the edges or outlines of objects that are in focus.

### PEAKING PEAKING MODE

The Peaking Peaking mode displays a color overlay on top of in-focus edges. Select a Level of 1 to 10 (weak to strong) for the intensity of the color overlay. The RGB settings can change the appearance of the selected color overlay.

The Peaking Peaking mode indicator is applied after the image is scaled to a monitor, making the indicators appear differently on various monitors.

For more information about Peaking, refer to [Focus](#) in the How To section.

## LOG VIEW

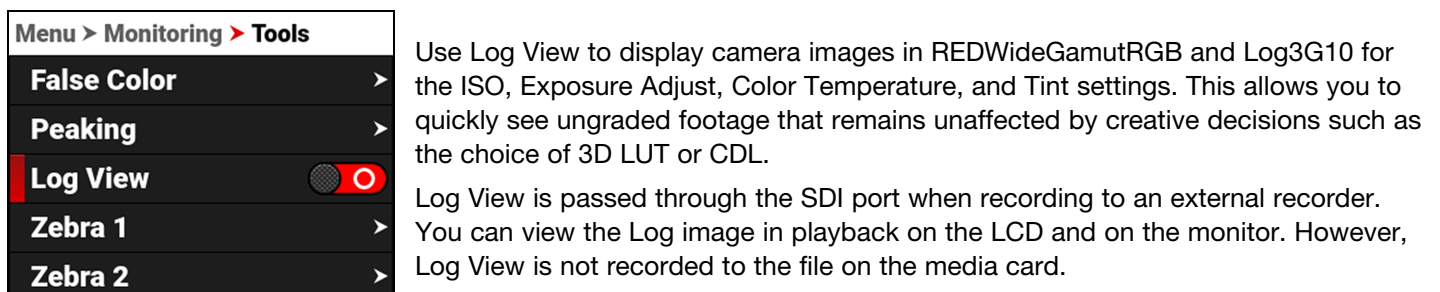

**NOTE:** Log View is only enabled on R3D files and not on ProRes files.

Press SEL to toggle the Log View switch between Enabled and Disabled:



## ZEBRA 1

Use Zebra 1 to display one set of diagonal stripes to indicate highlight exposure levels. For more information, refer to [Zebra Modes](#).

Zebra 1 is disabled by default.

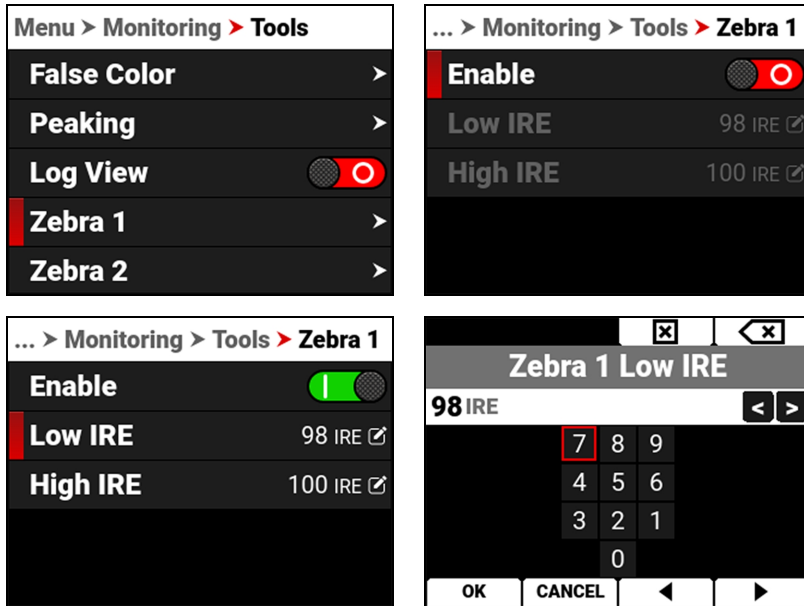

The Zebra 1 mode includes:

| ITEM     | DETAILS  |
|----------|--|
| Enable   | Enables red zebra stripes to indicate highlight exposure |
| Low IRE  | Sets the lower threshold for the indicator               |
| High IRE | Sets the higher threshold for the indicator              |

## ENABLE

The Enable toggle switch allows you to enable or disable the Zebra 1 stripes.

## LOW IRE

Provides a keypad that allows you to set the low threshold for the Zebra stripe. The default setting is 98 IRE.

## HIGH IRE

Provides a keypad that allows you to set the high threshold for the Zebra stripe. The default setting is 100 IRE.

## NORMAL VIEW

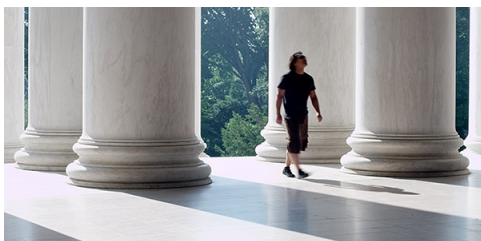

## ZEBRA 1 VIEW

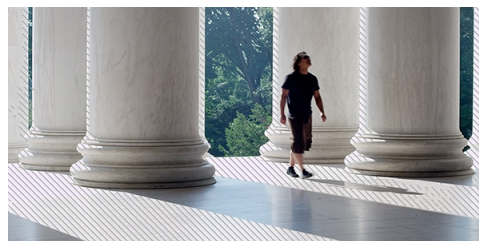

## ZEBRA 2

Use Zebra 2 to display a second set of diagonal stripes to indicate mid-tone and shadow levels. For more information, refer to [Zebra Modes](#).

Zebra 2 is disabled by default.

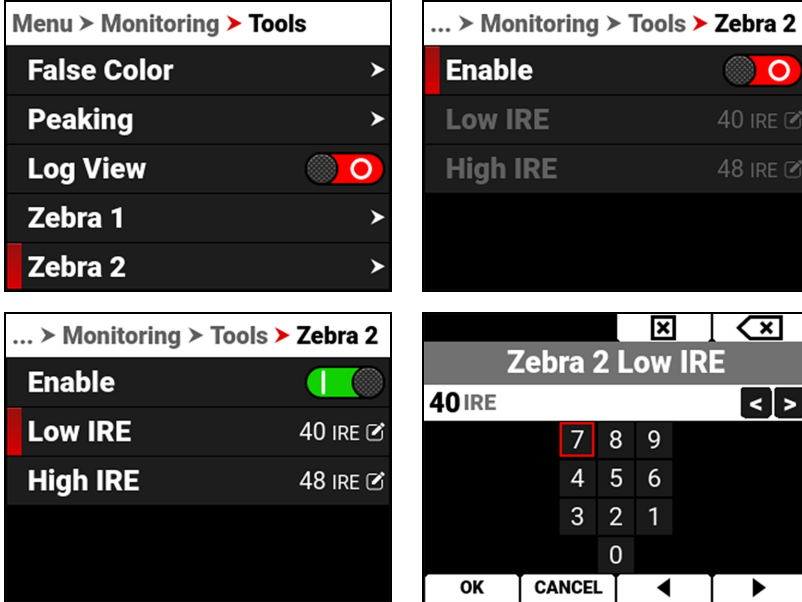

The Zebra 2 mode includes:

| ITEM     | DETAILS  |
|----------|--|
| Enable   | Enables green zebra stripes to indicate mid-tone and shadow exposure |
| Low IRE  | Sets the lower threshold for the indicator                           |
| High IRE | Sets the higher threshold for the indicator                          |

## ENABLE

The Enable toggle switch allows you to enable or disable the Zebra 2 stripes.

## LOW IRE

Provides a keypad that allows you to set the low threshold for the Zebra stripe. The default setting is 40 IRE.

## HIGH IRE

Provides a keypad that allows you to set the high threshold for the Zebra stripe. The default setting is 48 IRE.

## NORMAL VIEW

## ZEBRA 1 VIEW

## ZEBRA 2 VIEW

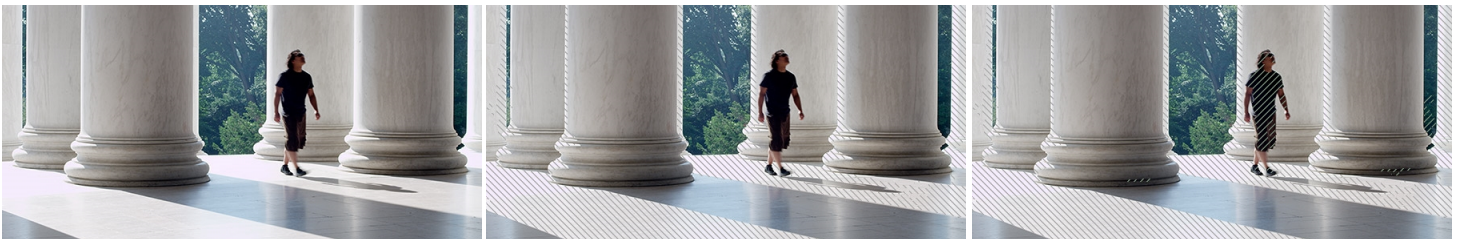

## GUIDES

Use Guides to enable and configure the camera's monitoring guides.

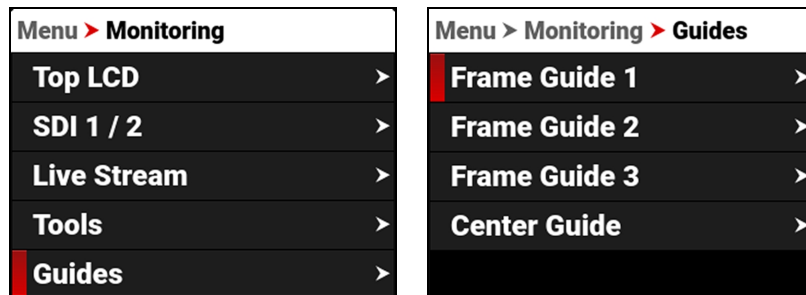

The monitoring Guides that you can use include:

| ITEM         | DETAILS  |
|--------------|--|
| Frame Guides | Guides you can configure to aid in framing a shot          |
| Center Guide | A center cross hair or dot you can use to center your shot |

## FRAME GUIDES

Use Frame Guides to frame the scene using various shapes and sizes. You can configure up to 3 Frame Guides to display on your monitor.

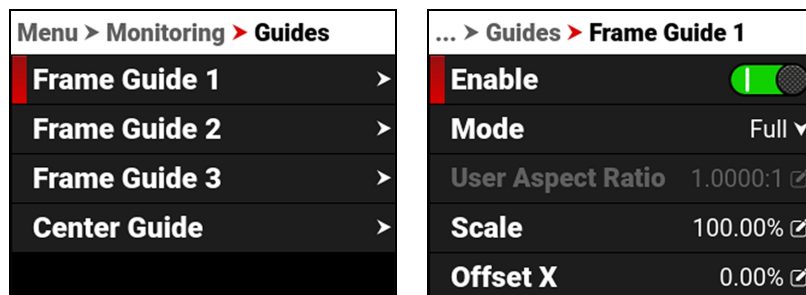

Configure the Frame Guides using the following:

| ITEM                | DETAILS  |
|---------------------|--|
| Enable              | Enables the Frame Guide  |
| Mode                | Select aspect ratios, User, and Absolute modes                 |
| User Aspect Ratio   | Enabled by selecting User mode                                 |
| Scale               | Percentage of the image the Frame Guide occupies               |
| Offset X, Y         | Percentage of horizontal and vertical offset                   |
| Absolute X, Y, W, H | Absolute mode - set the exact number of size and offset pixels |
| Line Style          | Select the Frame Guide line type - solid, dashed or bracket    |
| Line Color          | Select the Frame Guide line color                              |
| Line Opacity        | Select the Frame Guide line opacity                            |
| Shade Outside       | Enables shading outside of the Frame Guide                     |
| Shade Color         | Select the shading color                                       |
| Shade Opacity       | Select the shading opacity                                     |

## MODE

Use Mode to select the Frame Guide mode you want to use to configure the frame guide.

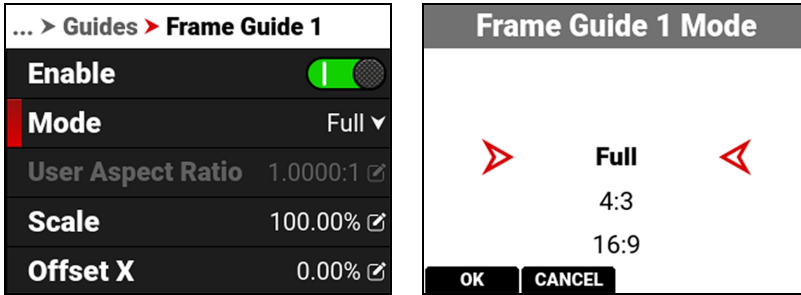

The modes you can select include aspect ratios from Full to 2.4:1, User, and Absolute. The User and Absolute modes enable settings that are specific to those modes.

## USER ASPECT RATIO

This item is enabled when the User mode is selected.

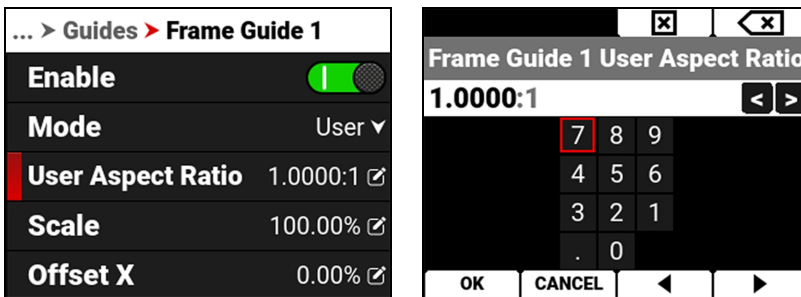

Use the keypad to enter your desired aspect ratio.

## SCALE

Use scale to configure the percentage of the image area that the Frame Guide will frame.

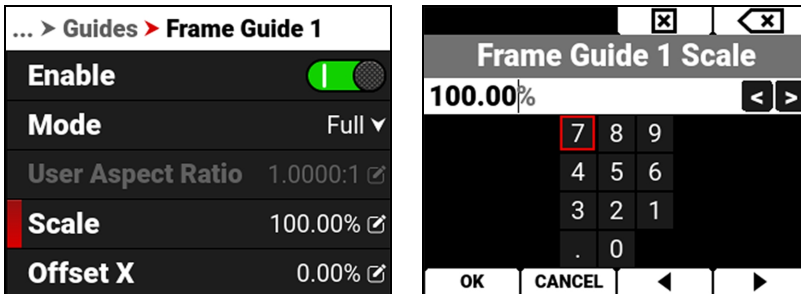

Use the keypad to enter the percentage of the image the Frame Guide contains.

## OFFSET X, Y

Use offset to configure the X and Y offset of the Frame Guide.

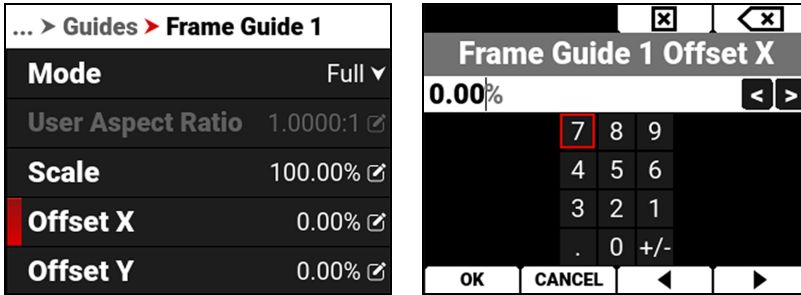

Use the keypad to enter the percentage of offset from center you want to apply to the Frame Guide.

## ABSOLUTE X, Y, W, H

Use the Absolute settings to configure the absolute dimensions and position of the Frame Guide.

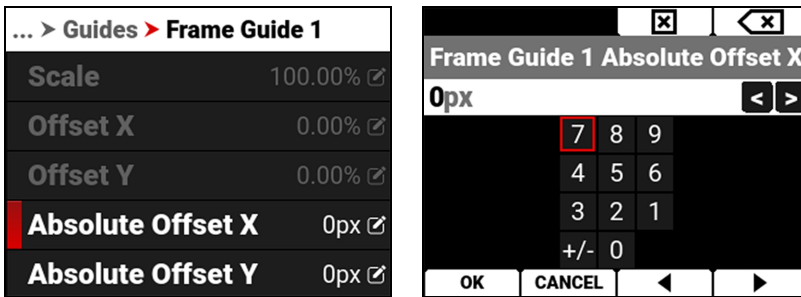

Use the keypad to enter the number of pixels for X/Y offset and for the width and height of the Frame Guide. The Absolute items are only enabled when you select Absolute **Mode**.

## LINE STYLE

Use Line Style to select the type of line the Frame Guide uses.

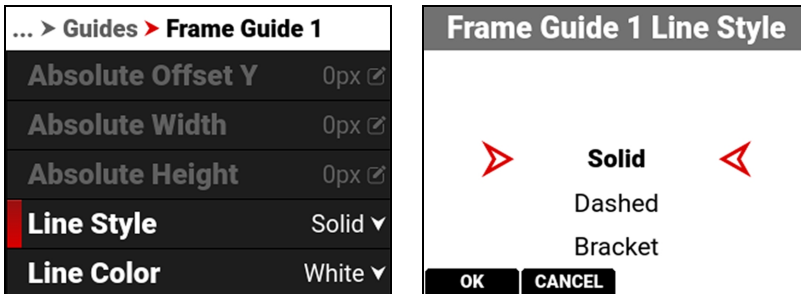

Select Solid (default), Dashed, or Bracket for the Frame Guide line style.



## LINE COLOR

Use Line Color to select the color of the Frame Guide line.

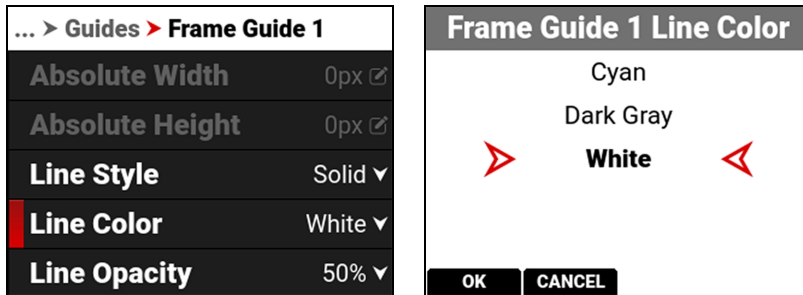

Use Line Color to select one of the following colors for the Frame Guide:

- Black      • Green      • Cyan
- Red        • Yellow     • Dark Gray
- Blue       • Magenta   • White (default)

## LINE OPACITY

Use Line Opacity to select how transparent the Frame Guide line appears.

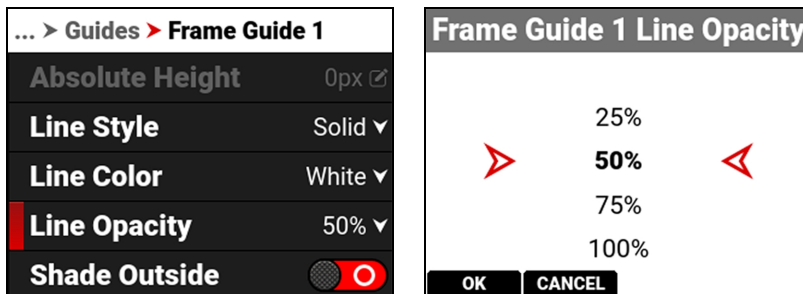

Use Line Opacity to select the percentage of opacity for the Frame Guide:

- 25%
- 50% (default)
- 75%
- 100%

## SHADE COLOR

Use Shade Color to select the color of shading to use outside of the Frame guide.

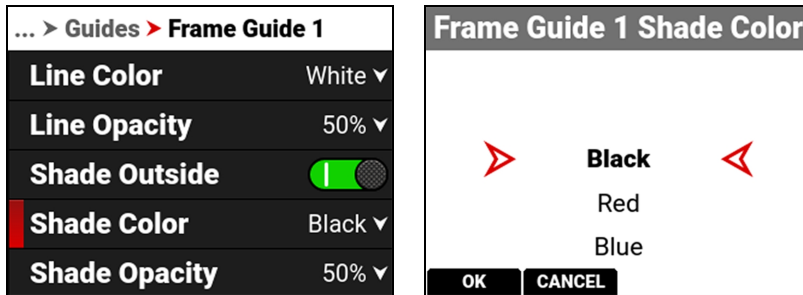

Use Shade Color to select one of the following colors for the outside shading:

- Black (default)
- Red
- Blue
- Green
- Yellow
- Magenta
- Cyan
- Dark Gray
- White

## SHADE OPACITY

Use Shade Opacity to select the opacity of the shading outside of the Frame guide.

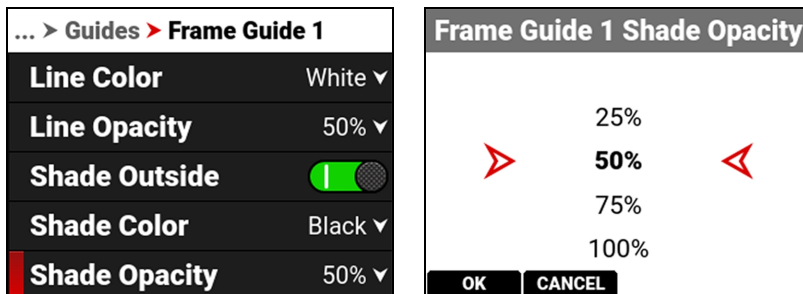

Use Shade Opacity to select the percentage of opacity for the shading outside of the Frame Guide:

- 25%
- 50% (default)
- 75%
- 100%

## CENTER GUIDE

Use Center Guide to enable and configure the Center Guide.

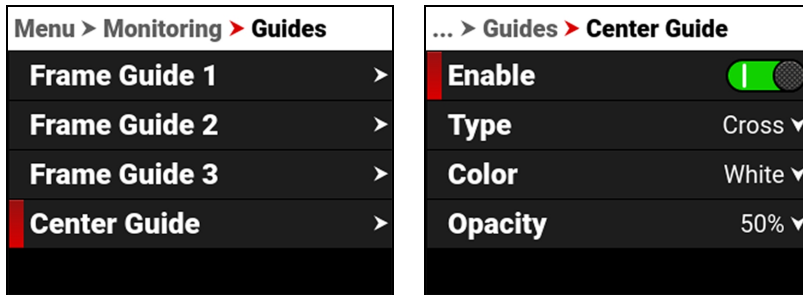

Configure the Center Guide by using the following:

| ITEM    | DETAILS                                  |
|---------|--|
| Enable  | Enables the Center Guide                 |
| Type    | Select Center Guide type - dot or cross  |
| Color   | Select a color for the Center Guide      |
| Opacity | Percentage of opacity of the guide color |

## TYPE

Use Type to select the type of Center Guide to display.

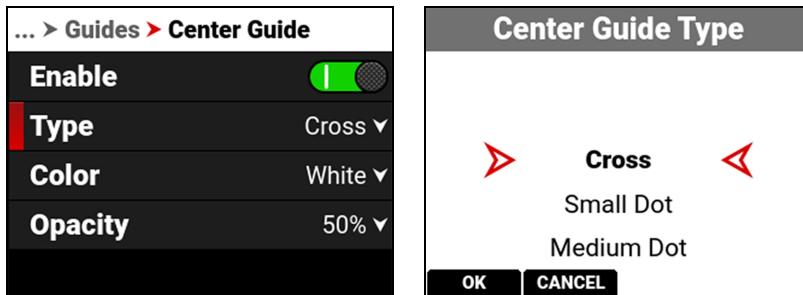

Use Type to select a center dot or cross (default) for the Center Guide.

## COLOR

Use Color to select the color used by the Center Guide.

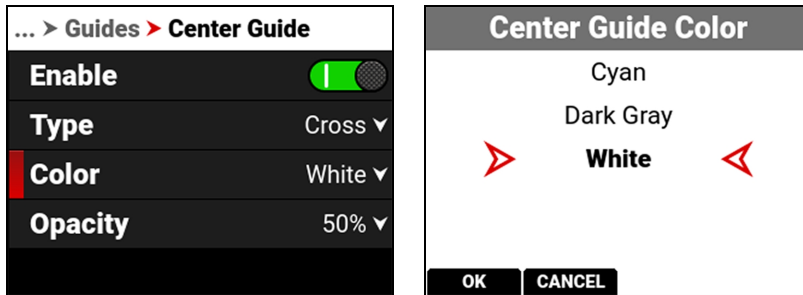

Use Color to select one of the following colors for the Center Guide:

- Black
- Green
- Cyan
- Red
- Yellow
- Dark Gray
- Blue
- Magenta
- White (default)

## OPACITY

Use Opacity to select how transparent the Center Guide appears.

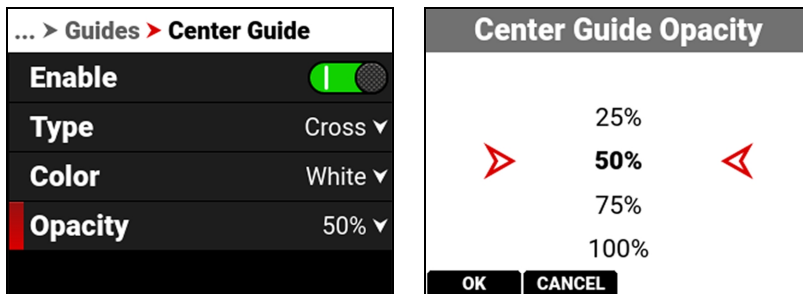

Use Opacity to select the percentage of opacity for the Center Guide:

- 25%
- 50% (default)
- 75%
- 100%

## MEDIA MENU

The Media menu contains the settings you use to configure your media.

From the camera LCD menu, navigate to Media and press SEL:

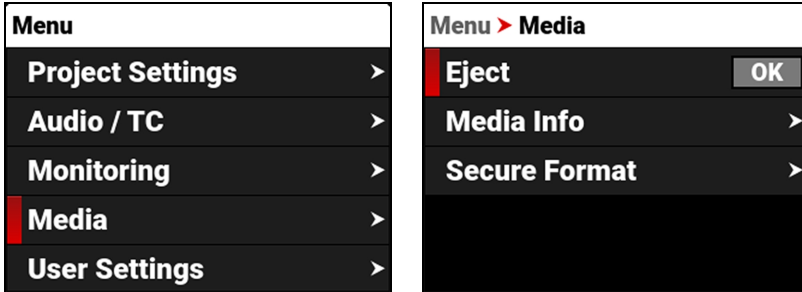

Use the Media menu to configure the camera's storage media settings and to view the media information:

| ITEM          | DETAILS  |
|---------------|--|
| Eject         | Eject the CFexpress media card                       |
| Media Info    | View the CFexpress media card information            |
| Secure Format | Performs a secure format of the CFexpress media card |

## EJECT

Use Eject to safely eject the CFexpress media card.

**WARNING:** The media can get extremely hot. Use caution when removing media.

**WARNING:** Do not attach a label to the CFexpress media card. The heat generated by the media can weaken the label's adhesive, causing the label to detach inside of the camera. Labels can also diminish heat dissipation and cause excessive wear to the internal components. Removing a label from a CFexpress media card can possibly deform the card body.

Access Eject from the **LCD** Media menu:

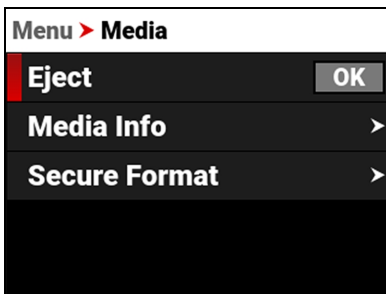

For more information, refer to [Media Management](#).

## MEDIA INFO

Use Media Info to display the CFexpress media card information.

Access Media Info from the **LCD** Media menu:

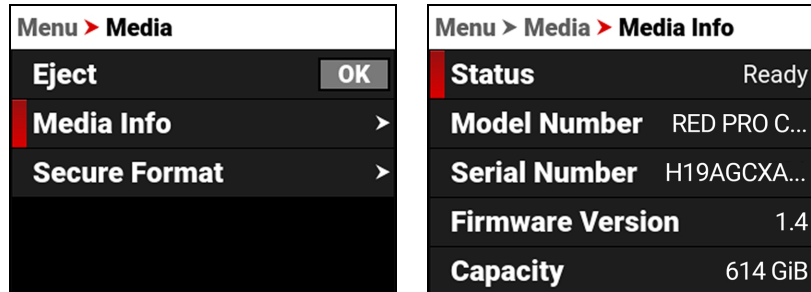

Media Info displays the following:

| ITEM             | DETAILS   |
|------------------|---|
| Status           | Displays the CFexpress media card status                          |
| Model Number     | Displays the CFexpress media card model number                    |
| Serial Number    | Displays the CFexpress media card serial number                   |
| Firmware Version | Displays the CFexpress media card firmware version                |
| Capacity         | Displays the CFexpress media card total capacity                  |
| Available        | Displays the CFexpress media card's remaining storage             |
| Time Remaining   | Displays the recording time remaining on the CFexpress media card |

## SECURE FORMAT

Use Secure Format to format the CFexpress media card down to the file system level.

A secure format allows you to rebuild the card file system.

**WARNING:** Secure Format permanently deletes all information from the media card. Data cannot be recovered after a Secure Format.

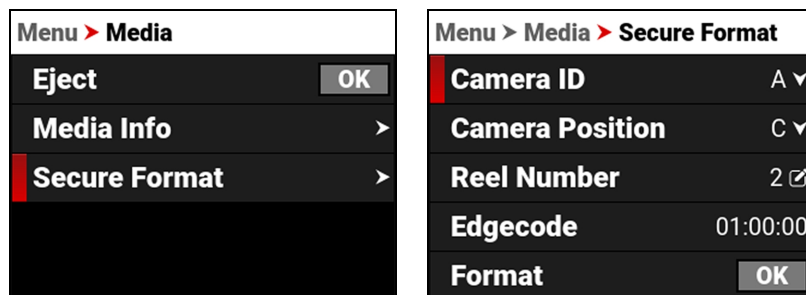

Use the Secure Format menu to update the following information:

| ITEM            | DETAILS                                     |
|-----------------|---|
| Camera ID       | Select the camera ID (default is A)         |
| Camera Position | Select the camera position (default is C)   |
| Reel Number     | Select the reel number (default is 1)       |
| Edgecode        | Enter the time number (default is 01:00:00) |
| Format          | Starts the Secure formatting process        |

## CAMERA ID

Use Camera ID to assign a camera ID letter to the media.

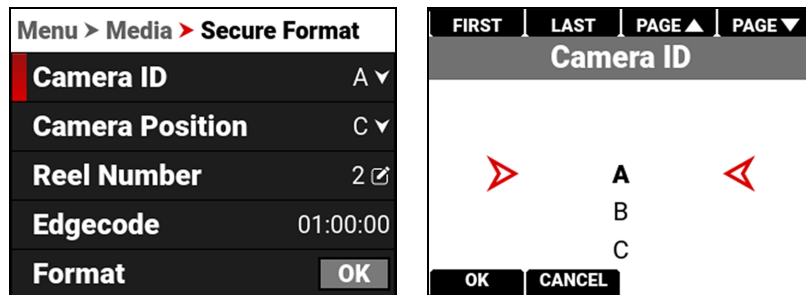

The Camera ID letters you can assign range from A-Z. For more information, refer to [Secure Format](#).

## CAMERA POSITION

Use Camera Position to select the camera position label for the CFexpress media card.

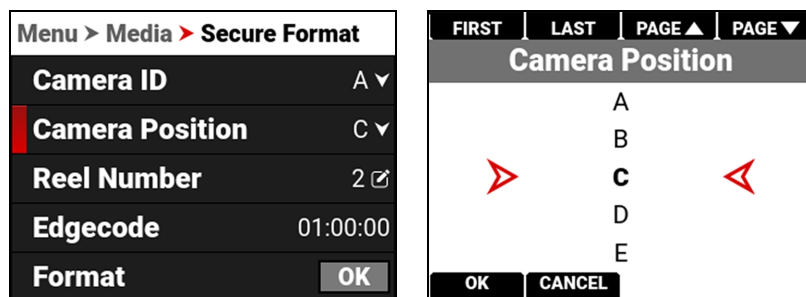

The Camera Position letters you can assign range from A-Z. For more information, refer to [Secure Format](#).

## REEL NUMBER

Use Reel Number to assign a reel number to the media.

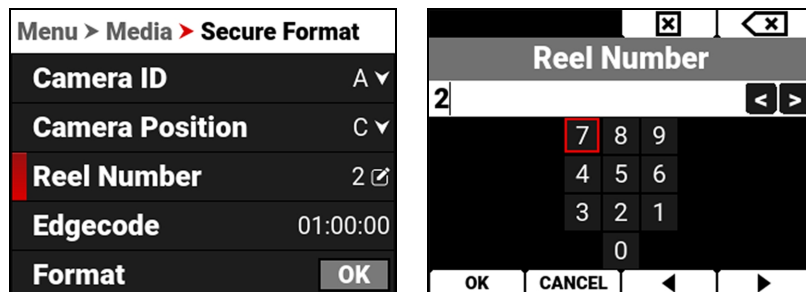

Use the keypad to enter a unique reel number to the media.

**NOTE:** It is best practice to keep your reel numbers to no longer than seven characters in length to conform with all edit decision list (EDL) formats.

For more information, refer to [Secure Format](#).

## EDGECODE

Use Edgecode to assign an edgecode to the media.

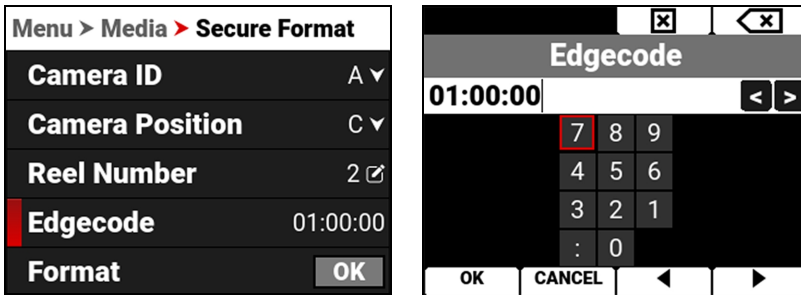

Use the keypad to enter a unique edgecode number to the media.

Edgecode is a SMPTE Timecode track that by default starts at 01:00:00 on the first frame of each CFexpress media card. It is a sequential code that is continuous from frame to frame and also between clips. Edgecode is equivalent to RUN RECORD as used on broadcast cameras.

For more information, refer to [Secure Format](#).

## FORMAT

Use Format to execute a secure format of the media.

**WARNING:** Formatting permanently deletes all information from the media card. Data cannot be recovered after a format.

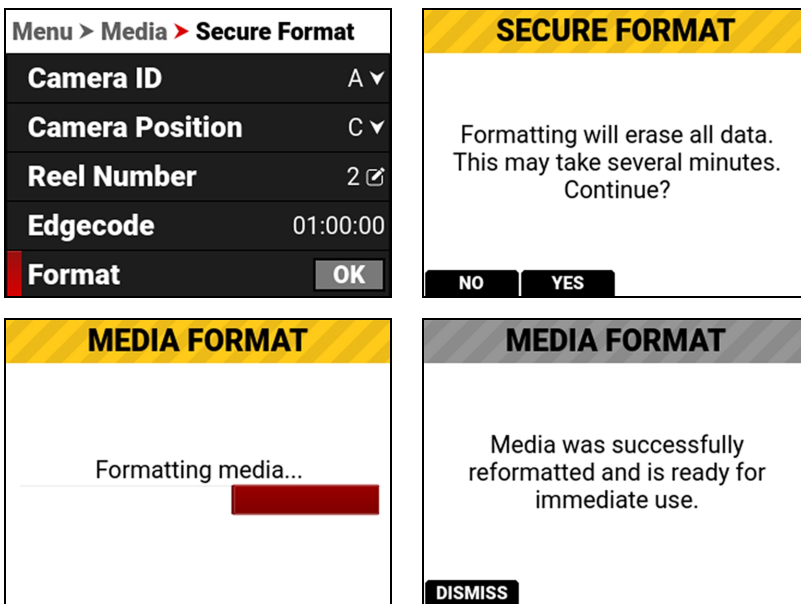

For more information, refer to [Secure Format](#).



## USER SETTINGS MENU

The User Settings menu contains the user settings you use to personalize your camera setup.

From the camera LCD menu, navigate to User Settings and press SEL:

| Menu          |   | Menu > User Settings    |   |
|---------------|---|-------------------------|---|
| Audio / TC    | > | Presets                 | > |
| Monitoring    | > | Side LCD Control Panels | > |
| Media         | > | User 1                  | > |
| User Settings | > | User 2                  | > |
| Autofocus     | > | User 3                  | > |

Use the User Settings menu to build and select pre-configured settings for the camera:

| ITEM                    | DETAILS                                   |
|-------------------------|---|
| Presets                 | Create camera setting presets             |
| Side LCD Control Panels | Enable or disable the camera LCD pages    |
| User 1, 2, 3            | Configure 8 user settings on 3 user pages |
| User Buttons            | Assign functions to user buttons          |

## PRESETS

The Presets menu contains the settings you use to quickly set up your camera.

| Menu > User Settings    |   | Menu > User Settings > Presets |   |
|-------------------------|---|--------------------------------|---|
| Presets                 | > | Create Preset                  | ▼ |
| Side LCD Control Panels | > | On Media Presets               | ▼ |
| User 1                  | > | In Camera Presets              | ▼ |
| User 2                  | > |                                |   |
| User 3                  | > |                                |   |

Use the Presets menu to build and select pre-configured settings for the camera:

| ITEM              | DETAILS                             |
|-------------------|-------------------------------------|
| Create Preset     | Create camera setting presets       |
| On Media Presets  | Manage presets stored on the media  |
| In Camera Presets | Manage presets stored in the camera |

## CREATE PRESET

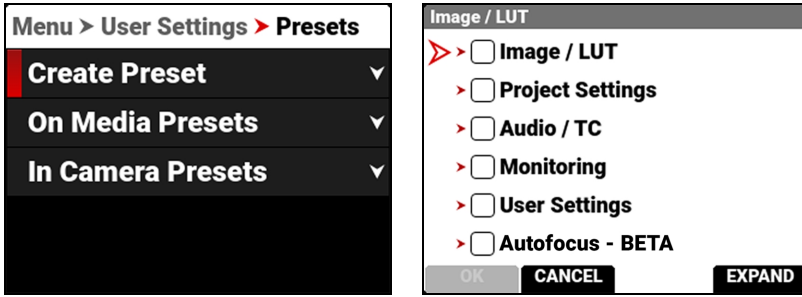

Use Create Preset to select the current camera settings you want to use to create a preset list of settings. You can use the EXPAND button to expand a menu to display submenu settings. The small arrows next to the boxes represent the number of submenu levels you have navigated. When the arrows are red, they indicate that there are more submenus to expand:

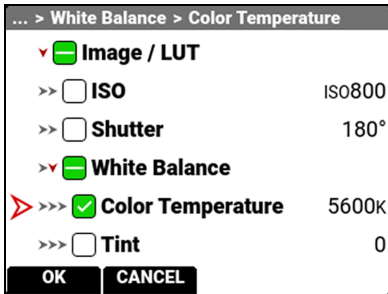

You can select settings individually:

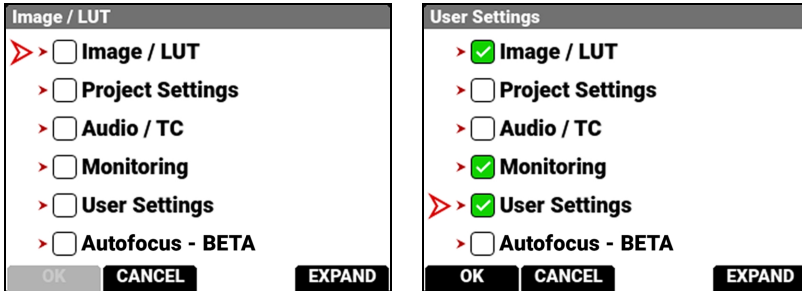

Press the button under OK to create the preset. The Preset Name screen opens.

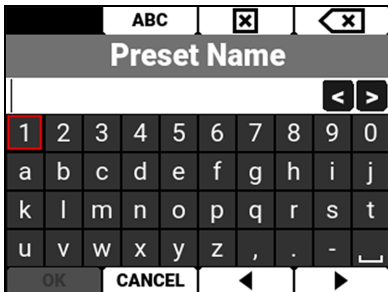

Use the Preset Name screen to name the preset. When the name already exists in the camera, the name is highlighted in red and the OK option is grayed out:



When the name is available, press the button under OK and the confirmation screen displays:

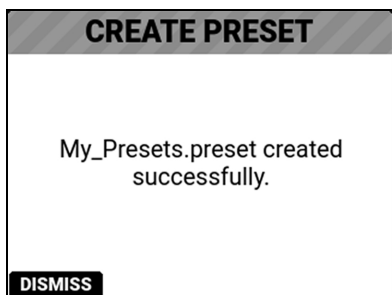

## ON MEDIA PRESETS



You can import presets from the media to the camera. Presets must be located on the media under a folder named "presets" to be populated here.

From Media Presets, you can import the selected preset from the media to the camera or import all of the presets from the media to the camera.

## IN CAMERA PRESETS

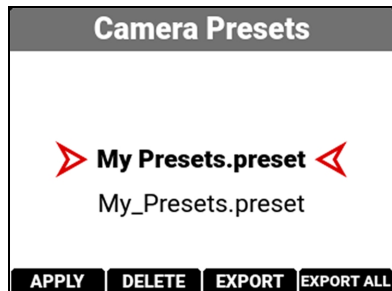

You can export presets from the camera to the media. When exporting presets from the camera to the media, the presets are saved to a folder on the media called "presets."

From Camera Presets, you can apply the selected preset to the camera, delete the selected preset from the camera, export the selected preset from the camera to the media, or export all of the presets from the camera to the media.

## SIDE LCD CONTROL PANELS

The Side LCD Control Panels menu contains the settings you use to enable/disable the LCD pages.

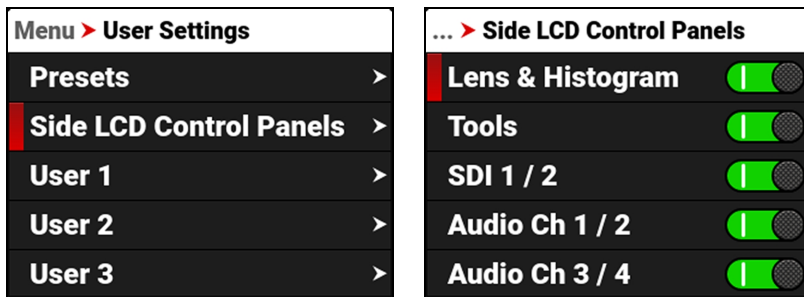

The pages you can toggle include:

- Histogram Page
- Tools Page
- SDI Page
- Audio Channels 1 / 2 Page
- Audio Channels 3 / 4 Page
- Headphone Page
- Sensor Sync Shift Page
- User Pages

## USER 1, 2, 3

The User menus contain the settings you saved to quickly configure your camera.

From the camera LCD menu, select User 1, 2, or 3:

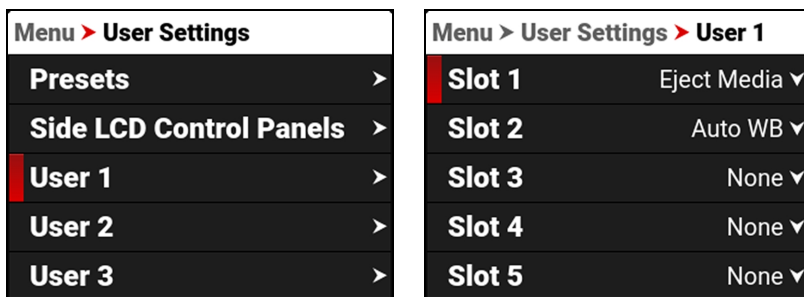

Use Slots 1-8 to assign quick user settings for the camera.

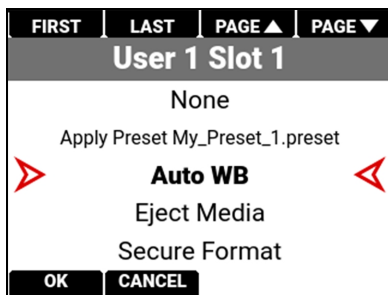

The user settings include:

| ITEM                     | DETAILS  |
|--------------------------|--|
| None                     | Nothing is assigned to the User Slot   |
| Apply Preset             | Apply the presets stored on the camera                                       |
| Auto WB                  | Camera automatically adjusts the White Balance                               |
| Eject Media              | Unmount the media in preparation for removal                                 |
| Secure Format            | Format the media   |
| Jam TC to TOD            | Jam Timecode to time of day  |
| Start AF                 | Start autofocus  |
| Save Log                 | Save the log file to the media   |
| SDI 1 Magnify Toggle     | Toggle magnification on and off on the SDI 1 output                          |
| SDI 2 Magnify Toggle     | Toggle magnification on and off on the SDI 2 output                          |
| Top LCD Magnify Toggle   | Toggle the magnification on and off on the <b>DSMC3™ RED® Touch 7.0" LCD</b> |
| Pre-Record Toggle        | Toggle the Pre-Record feature on and off                                     |
| Pre-Record Stop          | Stop the Pre-Record feature  |
| Playback/Camera Toggle   | Toggle between camera output and clip playback                               |
| Record Toggle            | Toggle record on and off   |
| False Color Toggle       | Toggle the False Color tools on and off                                      |
| Peaking Toggle           | Toggle the Peaking tools on and off  |
| Log View Toggle          | Toggle Log view on and off   |
| Zebra 1 Toggle           | Toggle Zebra 1 on and off  |
| Zebra 2 Toggle           | Toggle Zebra 2 on and off  |
| SDI 1 Guides Toggle      | Toggle the Guides on and off on SDI 1 output                                 |
| SDI 1 Tools Toggle       | Toggle the Tools on and off on the SDI 1 output                              |
| SDI 1 Overlay Toggle     | Toggle between the simple and advanced Overlay on the SDI 1 output           |
| SDI 2 Guides Toggle      | Toggle the Guides on and off on the SDI 2 output                             |
| SDI 2 Tools Toggle       | Toggle the Tools on and off on the SDI 2 output                              |
| SDI 2 Overlay Toggle     | Toggle between the simple and advanced Overlay on the SDI 2 output           |
| Top LCD Guides Toggle    | Toggle the Guides on and off on the Top LCD                                  |
| Top LCD Tools Toggle     | Toggle the Tools on and off on the Top LCD                                   |
| Frame Guide 1 Toggle     | Toggle Frame Guide 1 on and off  |
| Frame Guide 2 Toggle     | Toggle Frame Guide 2 on and off  |
| Frame Guide 3 Toggle     | Toggle Frame Guide 3 on and off  |
| Center Guide Toggle      | Toggle the Center Guide on and off   |
| Iris Open                | Open the iris  |
| Iris Close               | Close the iris   |
| Sensor Flip Toggle       | Toggle sensor flip and normal sensor   |
| Shutter Decrement        | Decrease the shutter setting by one increment                                |
| Shutter Increment        | Increase the shutter setting by one increment                                |
| Sync Shift Increment (1) | Increase the sync shift setting by one increment                             |
| Sync Shift Decrement (1) | Decrease the sync shift setting by one increment                             |

| ITEM                        | DETAILS  |
|-----------------------------|--|
| Sync Shift Increment (100)  | Increase the sync shift setting by 100 increments  |
| Sync Shift Decrement (100)  | Decrease the sync shift setting by 100 increments  |
| Sync Shift Increment (1000) | Increase the sync shift setting by 1000 increments |
| Sync Shift Decrement (1000) | Decrease the sync shift setting by 1000 increments |

## USER BUTTONS

The User Buttons menu allows you to control the function of the front camera button.

From the camera LCD menu, select User Buttons:

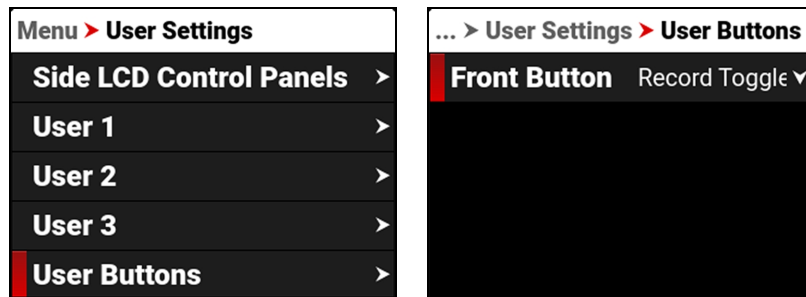

## FRONT BUTTON

Use Front Button to select the function you want assigned to the front camera button.

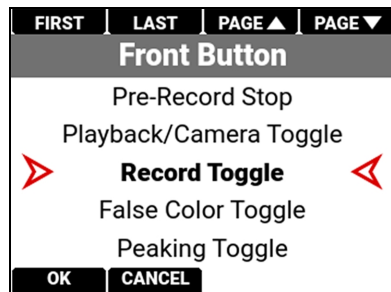

The default setting is Record Toggle.

The button settings include:

| ITEM                 | DETAILS  |
|----------------------|--|
| None                 | Nothing is assigned to the User Slot                   |
| Apply Preset         | Apply the presets stored on the camera                 |
| Auto WB              | Camera automatically adjusts the White Balance         |
| Eject Media          | Unmount the media in preparation for removal           |
| Secure Format        | Format the media                                       |
| Jam TC to TOD        | Jam Timecode to time of day                            |
| Start AF             | Start autofocus  |
| Save Log             | Save the log file to the media                         |
| SDI 1 Magnify Toggle | SDI port 1 toggle the magnification feature on and off |

| <b>ITEM</b>                 | <b>DETAILS</b>   |
|-----------------------------|--|
| SDI 2 Magnify Toggle        | SDI port 2 toggle the magnification feature on and off             |
| Top LCD Magnify Toggle      | Top LCD toggle the magnification feature on and off                |
| Pre-Record Toggle           | Toggle the Pre-Record feature on and off                           |
| Pre-Record Stop             | Stop the Pre-Record feature  |
| Playback/Camera Toggle      | Toggle between camera output and clip playback                     |
| Record Toggle (default)     | Toggle record on and off   |
| False Color Toggle          | Toggle the False Color tools on and off                            |
| Peaking Toggle              | Toggle the Peaking tools on and off                                |
| Log View Toggle             | Toggle Log view on and off   |
| Zebra 1 Toggle              | Toggle Zebra 1 on and off  |
| Zebra 2 Toggle              | Toggle Zebra 2 on and off  |
| SDI 1 Guides Toggle         | Toggle the Guides on and off on SDI 1 output                       |
| SDI 1 Tools Toggle          | Toggle the Tools on and off on the SDI 1 output                    |
| SDI 1 Overlay Toggle        | Toggle between the simple and advanced Overlay on the SDI 1 output |
| SDI 2 Guides Toggle         | Toggle the Guides on and off on the SDI 2 output                   |
| SDI 2 Tools Toggle          | Toggle the Tools on and off on the SDI 2 output                    |
| SDI 2 Overlay Toggle        | Toggle between the simple and advanced Overlay on the SDI 2 output |
| Top LCD Guides Toggle       | Toggle the Guides on and off on the Top LCD                        |
| Top LCD Tools Toggle        | Toggle the Tools on and off on the Top LCD                         |
| Frame Guide 1 Toggle        | Toggle Frame Guide 1 on and off                                    |
| Frame Guide 2 Toggle        | Toggle Frame Guide 2 on and off                                    |
| Frame Guide 3 Toggle        | Toggle Frame Guide 3 on and off                                    |
| Center Guide Toggle         | Toggle the Center Guide on and off                                 |
| Iris Open                   | Open the iris  |
| Iris Close                  | Close the iris   |
| Sensor Flip Toggle          | Toggle sensor flip and normal sensor                               |
| Shutter Decrement           | Decrease the shutter setting by one increment                      |
| Shutter Increment           | Increase the shutter setting by one increment                      |
| Sync Shift Increment (1)    | Increase the sync shift setting by one increment                   |
| Sync Shift Decrement (1)    | Decrease the sync shift setting by one increment                   |
| Sync Shift Increment (100)  | Increase the sync shift setting by 100 increments                  |
| Sync Shift Decrement (100)  | Decrease the sync shift setting by 100 increments                  |
| Sync Shift Increment (1000) | Increase the sync shift setting by 1000 increments                 |
| Sync Shift Decrement (1000) | Decrease the sync shift setting by 1000 increments                 |

## AUTOFOCUS MENU

Use Autofocus to enable and configure the camera's Autofocus feature. The lens and lens mount must support autofocus for this feature to work.

From the camera LCD menu, navigate to Autofocus and press SEL:

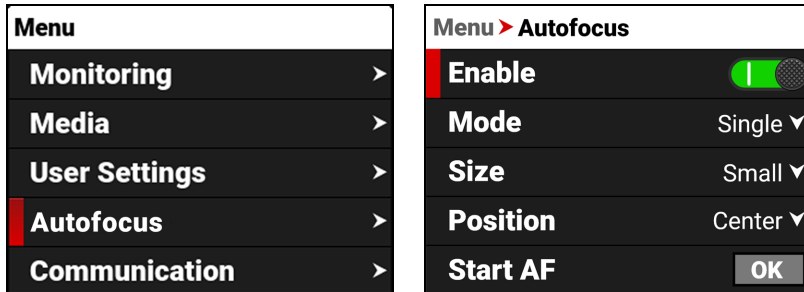

Use the Autofocus menu to perform camera autofocus tasks:

| ITEM     | DETAILS                                   |
|----------|---|
| Enable   | Enable/Disable the autofocus feature      |
| Mode     | Select the autofocus mode                 |
| Size     | Select the size of the autofocus area     |
| Position | Select the position of the autofocus area |
| Start AF | Start the Autofocus feature               |

## ENABLE

Use Enable to enable or disable the autofocus feature. The lens must support autofocus for the camera to use this feature.

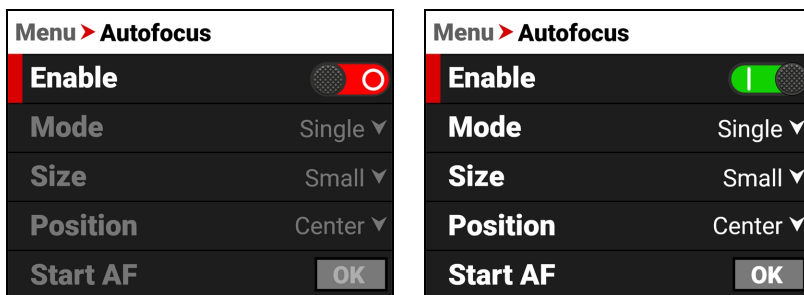



## MODE

Use Mode to select the autofocus mode for the camera. The lens must support autofocus for the camera to use this feature.

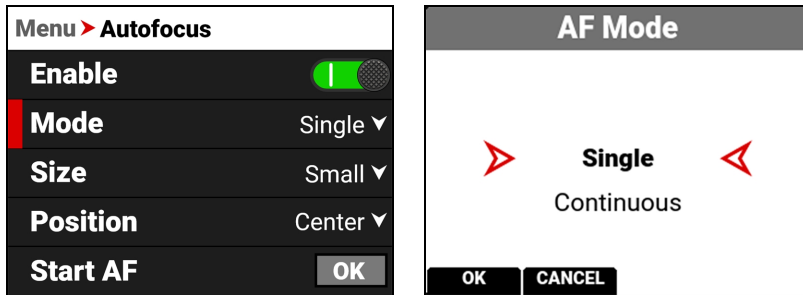

### SINGLE MODE (DEFAULT)

Use single mode to autofocus and then stop at that focus position.

### CONTINUOUS MODE

Use Continuous mode to continuously keep a moving subject in focus.

## SIZE

Use Size to choose what size area you want the camera to use for the autofocus feature. The lens must support autofocus for the camera to use this feature.

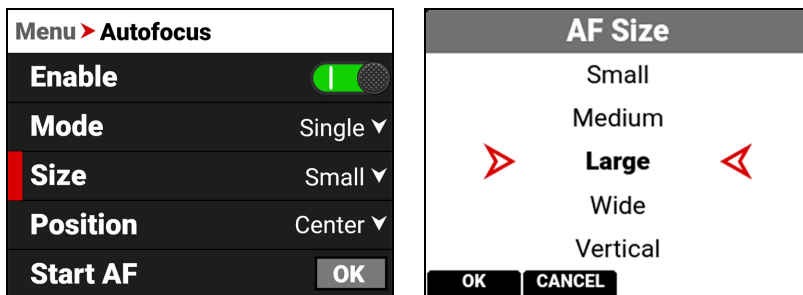

The Size selections for the autofocus area are Small (default), Medium, Large, Wide, and Vertical.

## POSITION

Use Position to specify the position of the autofocus area on the sensor. You can also use the **DSMC3™ RED® Touch 7.0" LCD** to drag the autofocus area to any location.

**NOTE:** The lens must support autofocus for the camera to use this feature.

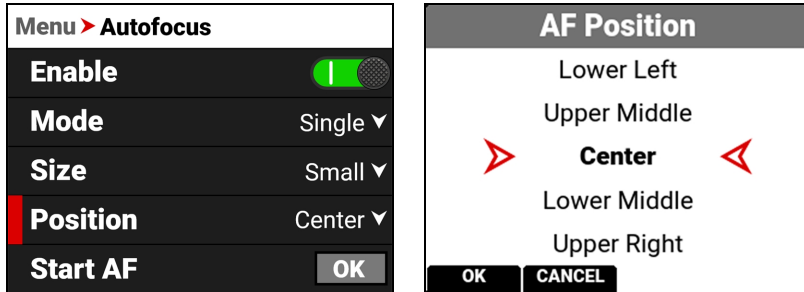

The Position selections include:

- Left
- Upper Middle
- Upper Right
- Upper Left
- Center (default)
- Lower Right
- Lower Left
- Lower Middle
- Right

The Autofocus Position rectangle displays on the monitor:

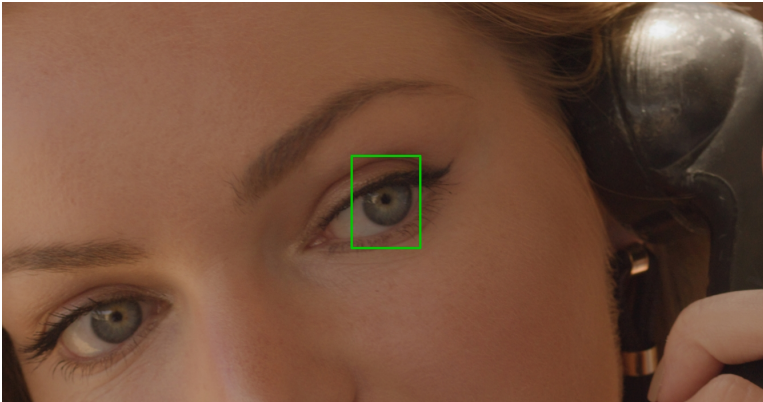

## COMMUNICATION MENU

The Communication menu contains the settings you use to configure your camera to communicate with other devices. From the camera LCD menu, navigate to Communication and press SEL:

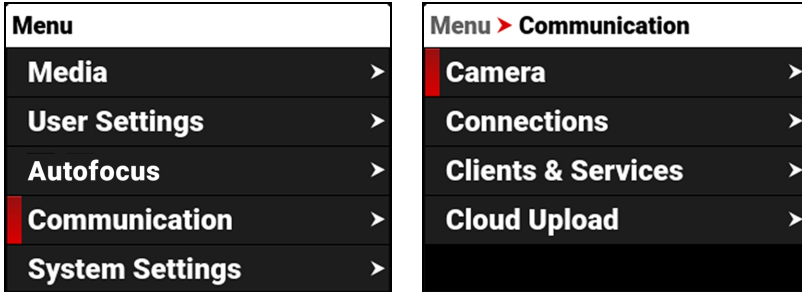

Use the Communication menu to configure the camera's communication settings:

| ITEM               | DETAILS   |
|--------------------|---|
| Camera             | Setting for the camera name                         |
| Connections        | Settings for USB-C, Wi-Fi, and Serial communication |
| Clients & Services | Settings for FTPS and PTP communication             |
| Cloud Upload       | Settings for Frame.io and AWS S3 communication      |

## CAMERA

Use the Camera menu to view and edit the camera name.

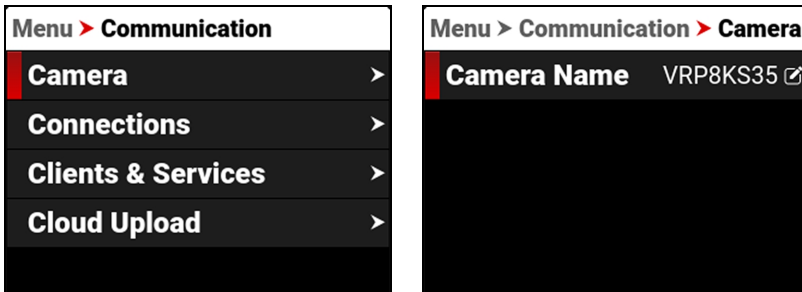

Select Camera Name to open the Camera Name editor.

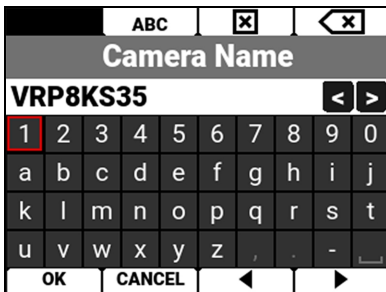

## CONNECTIONS

Use the Connections menu to select the connection you want to configure.

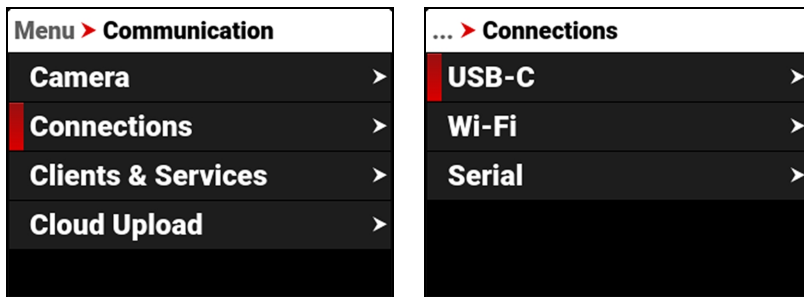

Use the Connections menu to configure the camera's connection settings:

| ITEM   | DETAILS   |
|--------|---|
| USB-C  | Select the camera USB-C connection settings     |
| Wi-Fi  | Configure the camera Wi-Fi connection settings  |
| Serial | Configure the camera serial connection settings |

### USB-C

Use USB-C to configure the connection to the USB-C port.



The settings you can configure for the USB-C port include:

| ITEM              | DETAILS                                     |
|-------------------|---|
| IP Assignment     | Displays the IP address assignment method   |
| Configure IP      | IP Address modes and configuration settings |
| IP Address        | View or enter the network IP address        |
| Netmask           | View or enter the network Netmask           |
| Gateway           | View or enter the network Gateway           |
| Advanced Settings | Change the MTU size                         |

### CONFIGURE IP

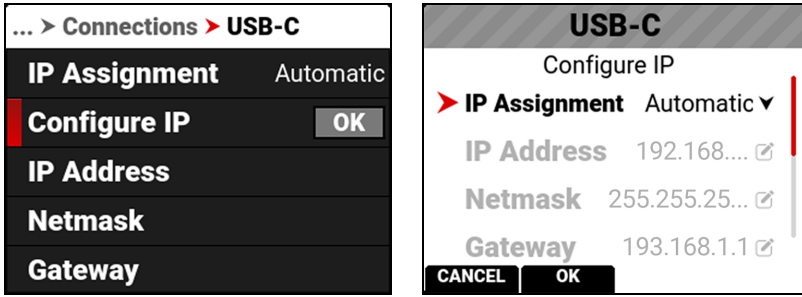

When connected to an Ethernet network, this allows you to automatically detect an IP address or to manually enter an IP address, Netmask address, and Gateway (router) address.

### IP ADDRESS

When connected to an Ethernet network and Automatic IP Assignment is enabled, IP Address displays the network IP address.

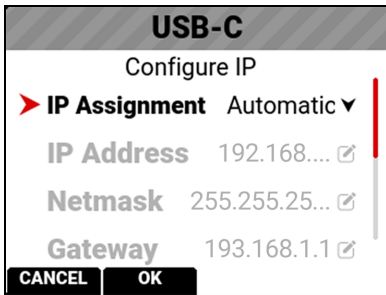

When Manual IP Assignment is enabled, you can select IP Address and manually enter a static IP address.

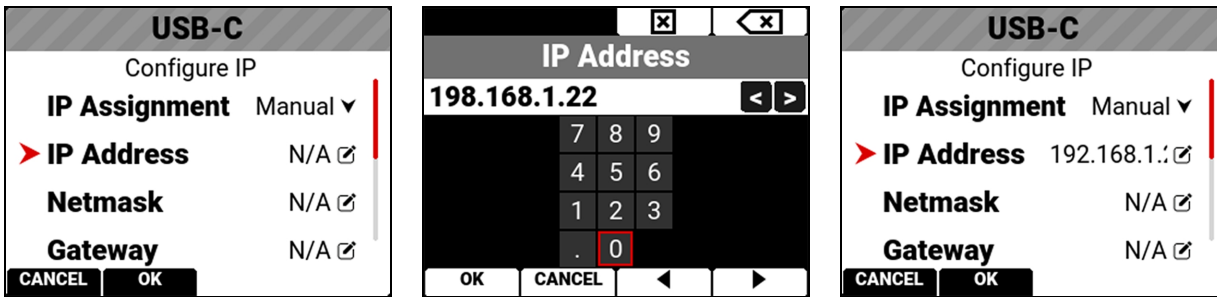

### NETMASK

When connected to an Ethernet network and Automatic IP Assignment is enabled, Netmask displays the network Netmask address.

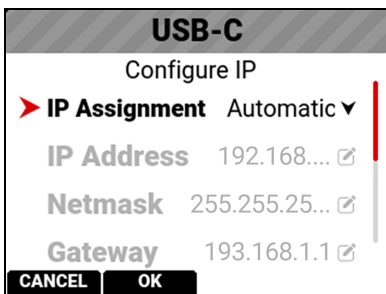

When Manual IP Assignment is enabled, you can select Netmask and manually enter a Netmask address.

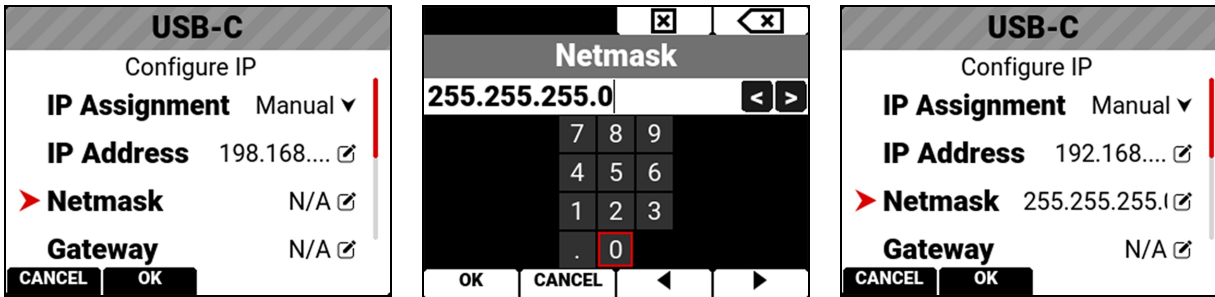

## GATEWAY

When connected to an Ethernet network and Automatic IP Assignment is enabled, Gateway displays the network Gateway address (router address).

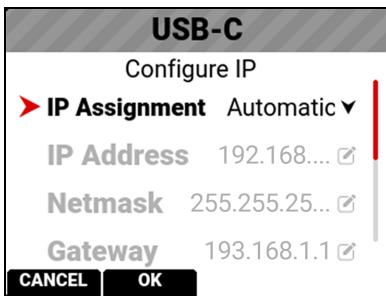

When Manual IP Assignment is enabled, you can select Gateway and manually enter a Gateway (router) address.

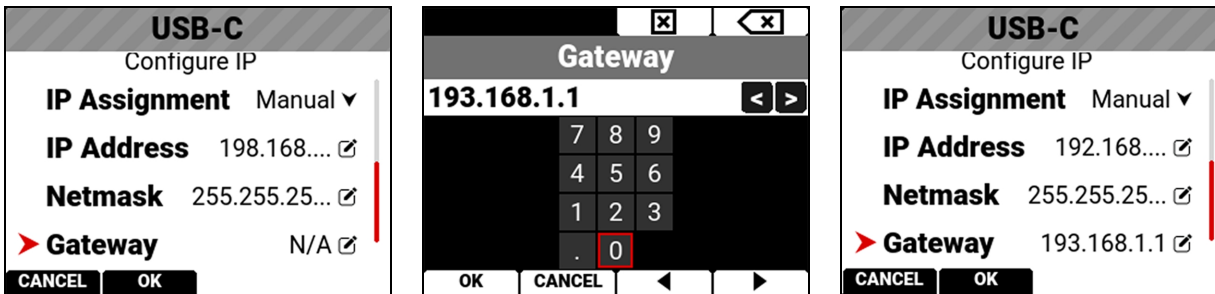

## ADVANCED SETTINGS

The USB-C Advanced Settings menu allows you to change the MTU size.

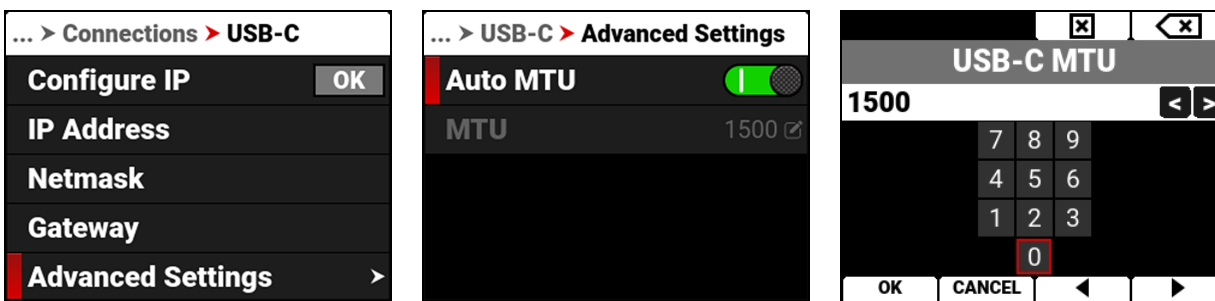

The Auto setting MTU size is 1500 bytes. You can set the MTU to a size larger than the standard 1500 bytes. This works best on fast Ethernet connections like Gigabit LAN. These large MTUs are known as Jumbo frames (as large as 9000 bytes) and they can increase data transmission efficiency and reduce overhead. However, Jumbo frame error correction is slower as a result of re-sending larger packets.

## WI-FI

Use Wi-Fi to configure the camera to work with a Wi-Fi connection.

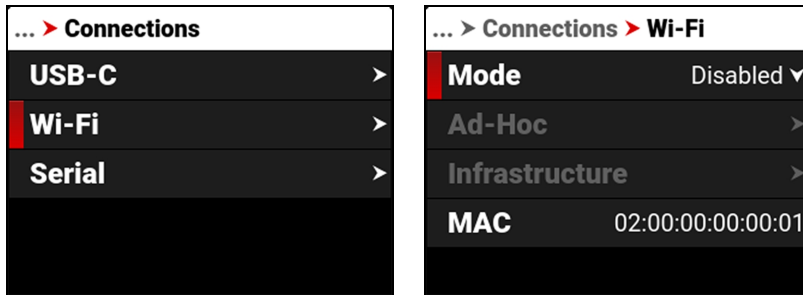

Use the Wi-Fi menu to configure the camera's Wi-Fi settings:

| ITEM           | DETAILS  |
|----------------|--|
| Mode           | Disable Wi-Fi or select the camera Wi-Fi settings    |
| Ad-Hoc         | Configure the camera as a Wi-Fi hot spot             |
| Infrastructure | Settings for connecting to an existing Wi-Fi network |
| MAC            | Displays the camera device MAC address               |

## MODE

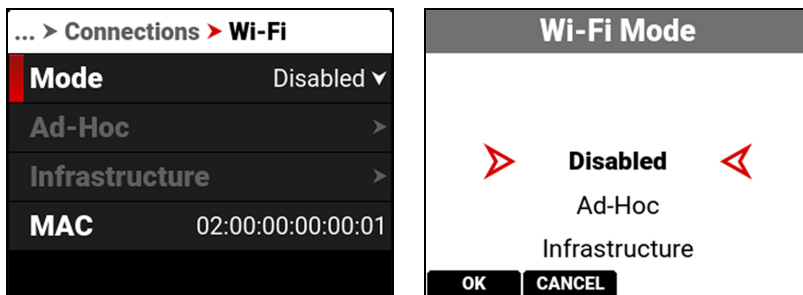

From Mode you can disable the Wi-Fi network, or you can enable the camera's **Ad-Hoc** or **Infrastructure** Wi-Fi settings. The default setting is Disabled.

## AD-HOC

Use Ad-Hoc to configure the camera as a Wi-Fi hot spot.

**NOTE:** The Ad-Hoc menu is enabled when the **Wi-Fi Mode** is set to **Ad-Hoc**.

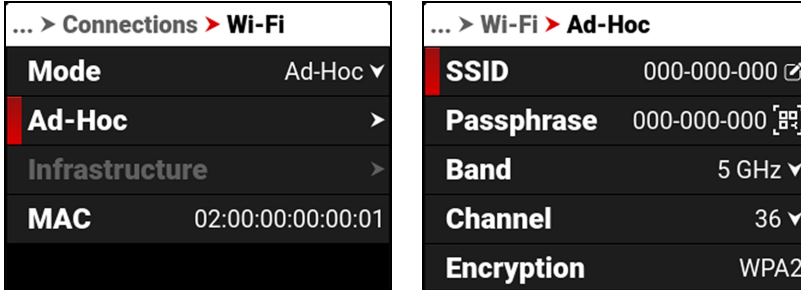

Use the Ad-Hoc menu to configure the Wi-Fi hot spot settings:

| ITEM       | DETAILS  |
|------------|--|
| SSID       | Enter the name of the Wi-Fi network the camera generates |
| Passphrase | Enter the password for the Wi-Fi network                 |
| Band       | Select the Wi-Fi frequency band                          |
| Channel    | Select the optimal channel for the Wi-Fi band            |
| Encryption | Displays the encryption type                             |
| Status     | Displays the connection status                           |
| IP Address | Displays the IP address                                  |
| Netmask    | Displays the Netmask                                     |

### SSID

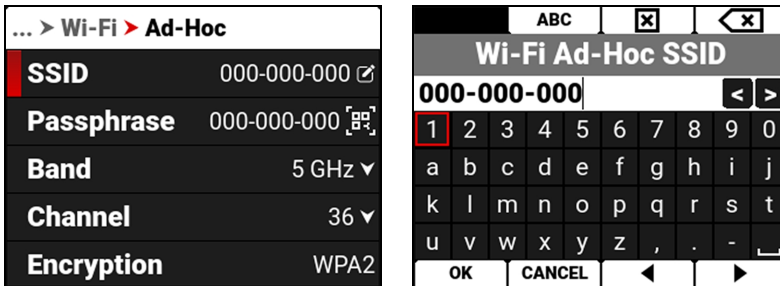

Use the keypad to enter the camera's Wi-Fi network name.

### PASSPHRASE



Use the keypad to enter the camera's Wi-Fi passphrase.



## BAND

|                      |             |
|----------------------|-------------|
| ... > Wi-Fi > Ad-Hoc |             |
| <b>SSID</b>          | 000-000-000 |
| <b>Passphrase</b>    | 000-000-000 |
| <b>Band</b>          | 5 GHz ▾     |
| <b>Channel</b>       | 36 ▾        |
| <b>Encryption</b>    | WPA2        |

**Wi-Fi Ad-Hoc Frequency Band**

2.4 GHz

**5 GHz**

OK   CANCEL

Select the camera's Wi-Fi network frequency band.

- Use 5 GHz for optimal wireless video streaming performance (default)
- Use 2.4 GHz for extended range remote control (when not utilizing wireless video streaming)

## CHANNEL

|                      |             |
|----------------------|-------------|
| ... > Wi-Fi > Ad-Hoc |             |
| <b>SSID</b>          | 000-000-000 |
| <b>Passphrase</b>    | 000-000-000 |
| <b>Band</b>          | 5 GHz ▾     |
| <b>Channel</b>       | 36 ▾        |
| <b>Encryption</b>    | WPA2        |

**Wi-Fi Ad-Hoc Channel**

36

40

44

OK   CANCEL

Select the optimal channel for the selected band, one which receives the least interference from the surrounding Wi-Fi signals.

## ENCRYPTION

|                      |             |
|----------------------|-------------|
| ... > Wi-Fi > Ad-Hoc |             |
| <b>Passphrase</b>    | 000-000-000 |
| <b>Band</b>          | 5 GHz ▾     |
| <b>Channel</b>       | 36 ▾        |
| <b>Encryption</b>    | WPA2        |
| <b>Status</b>        | Offline     |

The camera uses WPA2 security encryption.

## STATUS

|                      |   |
|----------------------|---|
| ... > Wi-Fi > Ad-Hoc |   |
| <b>Band</b>          | 5 GHz ▾   |
| <b>Channel</b>       | 36 ▾  |
| <b>Encryption</b>    | WPA2  |
| <b>Status</b>        | Offline   |
| <b>IP Address</b>    |  |

Displays the camera's Ad-Hoc Wi-Fi connection status.

The Ad-Hoc status includes Offline and Online.

## IP ADDRESS

|                      |               |
|----------------------|---------------|
| ... > Wi-Fi > Ad-Hoc |               |
| <b>Channel</b>       | 36 ▾          |
| <b>Encryption</b>    | WPA2          |
| <b>Status</b>        | Connected     |
| <b>IP Address</b>    | 198.168.1.1   |
| <b>Netmask</b>       | 255.255.255.0 |

When online and broadcasting a network, the camera displays an IP address.

## NETMASK

|                      |               |
|----------------------|---------------|
| ... > Wi-Fi > Ad-Hoc |               |
| <b>Channel</b>       | 36 ▾          |
| <b>Encryption</b>    | WPA2          |
| <b>Status</b>        | Connected     |
| <b>IP Address</b>    | 198.168.1.1   |
| <b>Netmask</b>       | 255.255.255.0 |

When online and broadcasting a network, the camera displays the Netmask for the IP address.

## INFRASTRUCTURE

Use Infrastructure to configure the camera to connect to an existing Wi-Fi network.

**NOTE:** The Infrastructure menu is enabled when the Wi-Fi Mode is set to **Infrastructure**. Refer to the **Wi-Fi** section for more information.

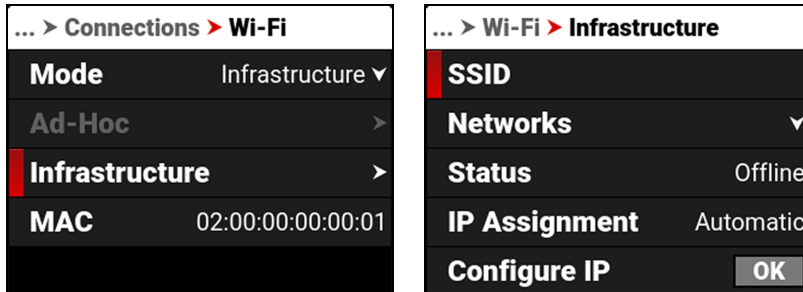

Use the Infrastructure menu to configure the Wi-Fi settings to connect to an existing Wi-Fi infrastructure:

| ITEM          | DETAILS   |
|---------------|---|
| SSID          | Displays the name of the connected Wi-Fi network                                    |
| Networks      | Scan for, select, or enter the Wi-Fi network  |
| Status        | Displays the Wi-Fi connection status  |
| IP Assignment | Displays the IP assignment method   |
| Configure IP  | Select the IP Assignment mode and manually enter IP, Netmask, and Gateway addresses |
| IP Address    | View or enter the Wi-Fi network IP address  |
| Netmask       | View or enter the Wi-Fi network Netmask   |
| Gateway       | View or enter the Wi-Fi network Gateway   |

## SSID

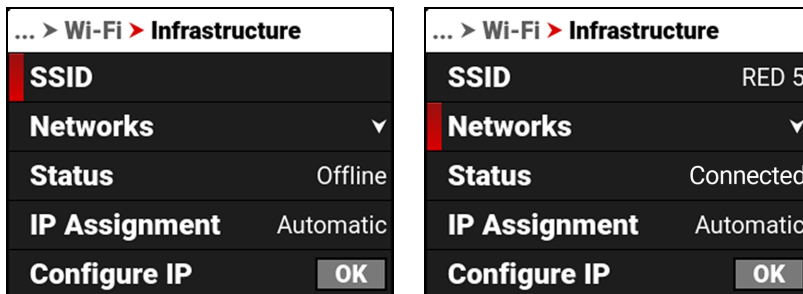

When a network is selected, the SSID displays the Wi-Fi network name (SSID).

## NETWORKS

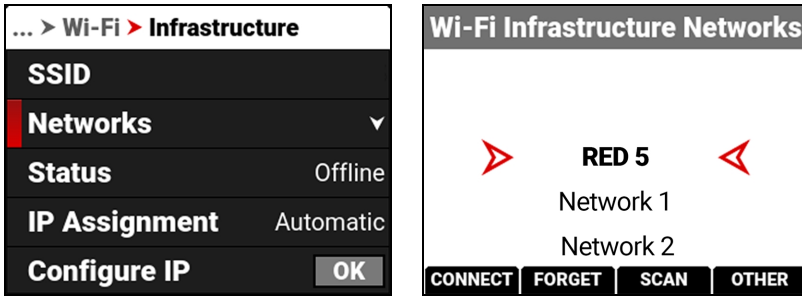

Use Networks to select an existing network, scan for an available network, or to configure a new network.

- **CONNECT:** The CONNECT button connects the camera to the selected network.
- **FORGET:** The FORGET button erases the connection information for the selected network.
- **SCAN:** The SCAN button searches for available networks.
- **OTHER:** The OTHER button opens the OTHER NETWORKS screen where you can manually enter an SSID and a Passphrase.

Select a network to open the CONNECT screen. Select Passphrase to open the Passphrase screen and enter the desired network password:

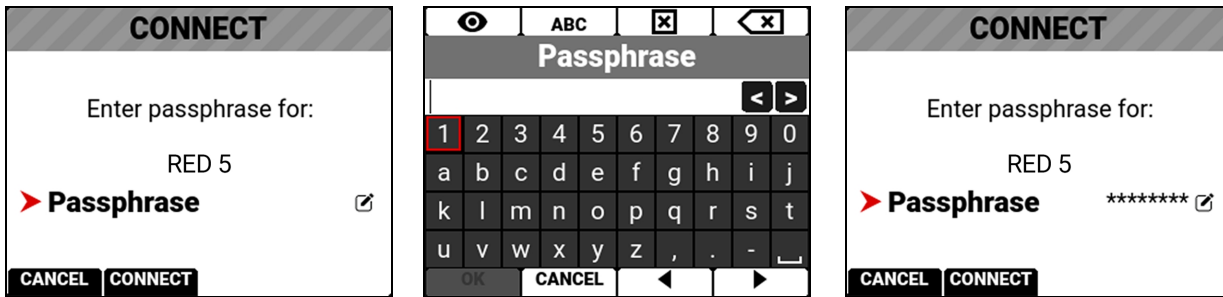

Press the button under CONNECT to connect to the new network:

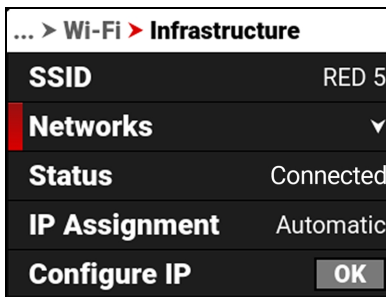

## STATUS

Displays the connection status of the camera to the selected Wi-Fi network.

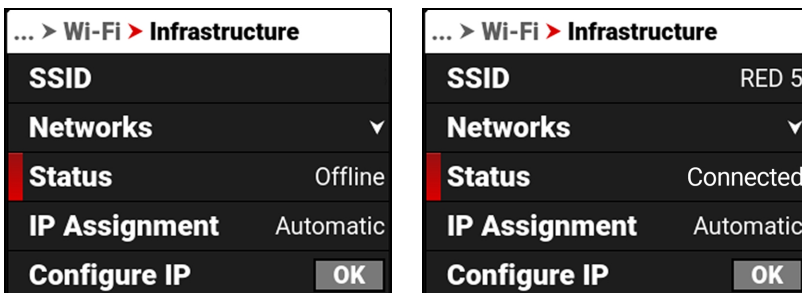

## IP ASSIGNMENT

Displays the selected IP Assignment mode.

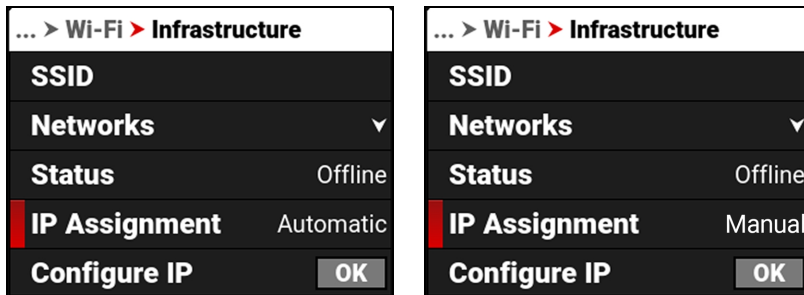

## CONFIGURE IP

Use Configure IP to select the IP Assignment method, and to manually enter an IP address, Netmask address, and a Gateway (router) address.

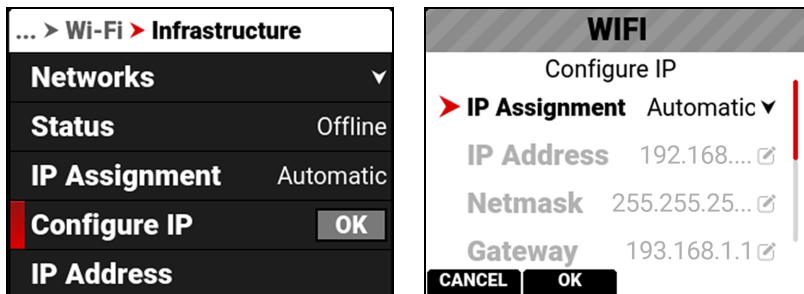

## IP ADDRESS

When connected to a Wi-Fi network and Automatic IP Assignment is enabled, IP Address displays the Wi-Fi network IP address.

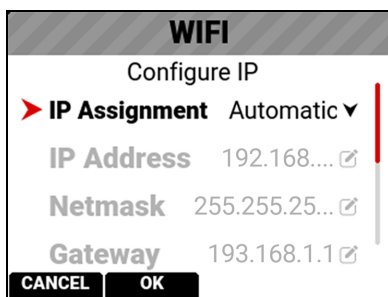

When Manual IP Assignment is enabled, you can manually enter a static IP address.

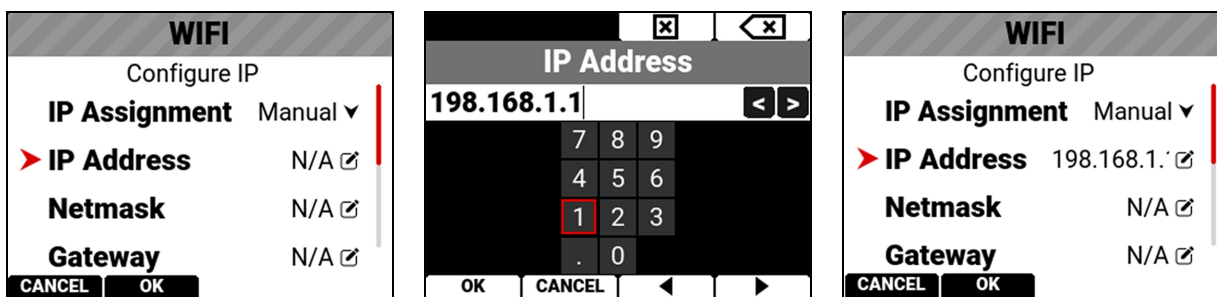

## NETMASK

When connected to a Wi-Fi network and Automatic IP Assignment is enabled, Netmask displays the Wi-Fi network Netmask address.

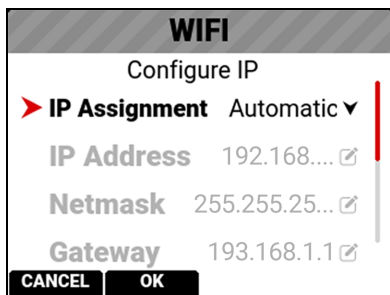

When Manual IP Assignment is enabled, you can manually enter a Netmask address.

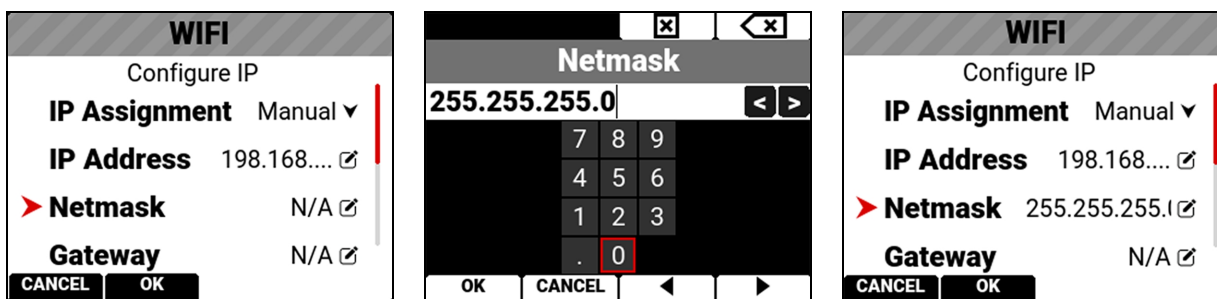

## GATEWAY

When connected to a Wi-Fi network and Automatic IP Assignment is enabled, Gateway displays the Wi-Fi network Gateway address (router address).

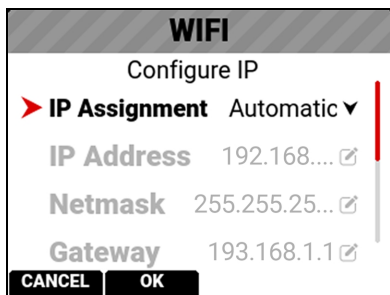

When Manual IP Assignment is enabled, you can manually enter a Gateway address.

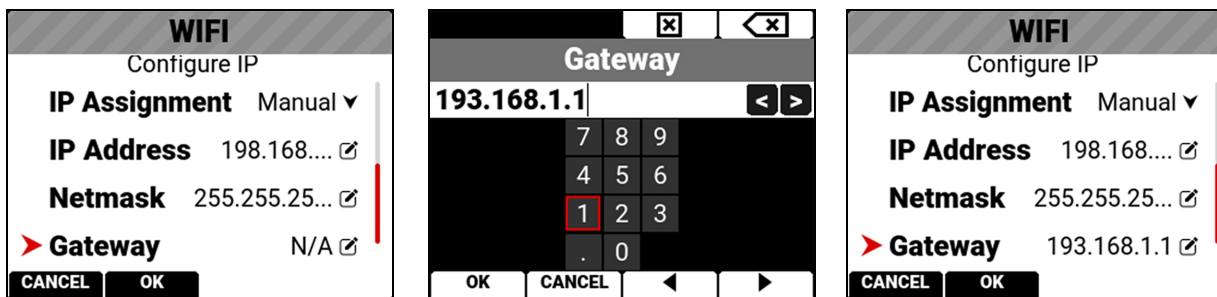

## SERIAL

Use Serial to configure the serial connection to the **Extension Port**.

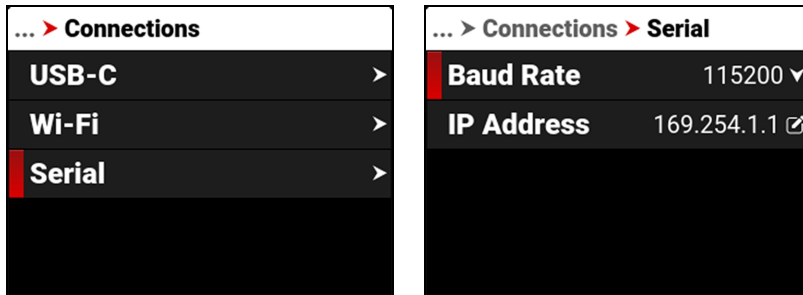

The settings you can configure for the serial connection through the Extension Port include:

| ITEM              | DETAILS                                   |
|-------------------|---|
| <b>Baud Rate</b>  | Select the serial port baud rate          |
| <b>IP Address</b> | Enter the IP address for the PPP protocol |

## BAUD RATE

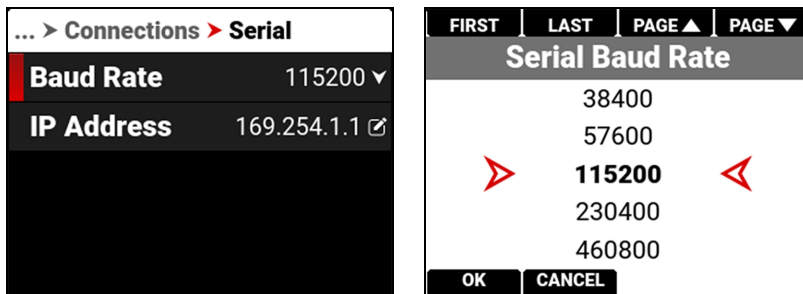

The Baud rate controls how fast data is transmitted over the serial connection. The higher the speed, the more likely that errors can occur. The Baud rates you can choose include:

| BAUD RATES |                  |         |         |
|------------|------------------|---------|---------|
| 9600       | 115200 (default) | 576000  | 1500000 |
| 19200      | 230400           | 921600  | 2000000 |
| 38400      | 460800           | 1000000 | 2500000 |
| 57600      | 500000           | 1152000 | 3000000 |

## IP ADDRESS

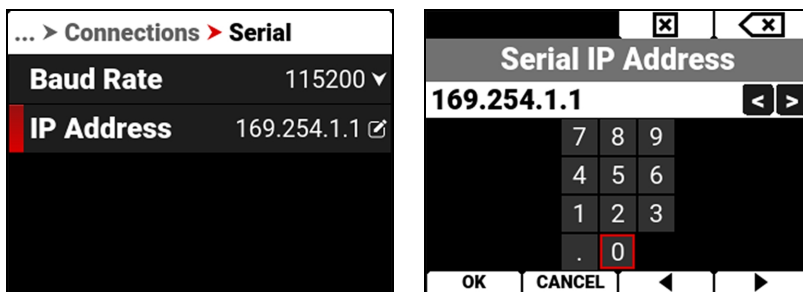

Use the keypad to enter the internet provider's IP address.

## CLIENTS & SERVICES

Use the Clients & Services menu to configure the client and service communications for the camera.

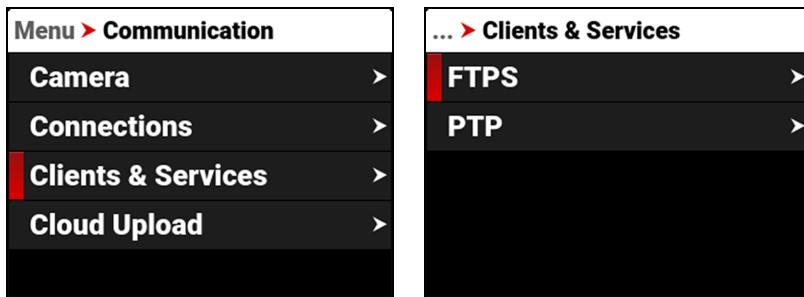

Use the Clients & Services menu to configure the camera's client and service settings:

| ITEM | DETAILS  |
|------|--|
| FTPS | Configure the camera FTPS communication settings |
| PTP  | Configure the camera PTP communications settings |

### FTPS

Use FTPS to configure the camera to work with a secure File Transfer Protocol (FTPS) connection.

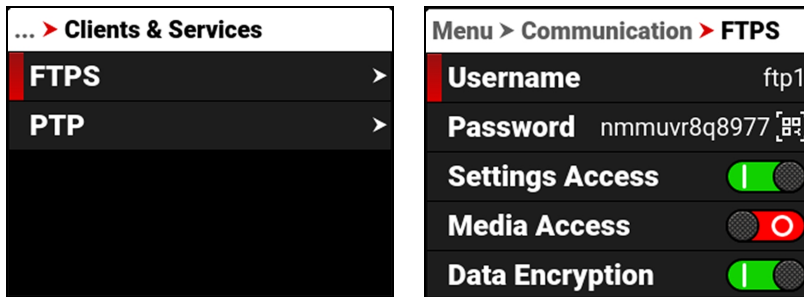

Use the FTPS menu to configure the camera's FTPS settings:

| ITEM              | DETAILS                                  |
|-------------------|--|
| Username          | Static username ftp1                     |
| Password          | User-editable password and QR code       |
| Settings Access   | Enable FTP access to the camera settings |
| Media Access      | Enable read-only access to the media     |
| Data Encryption   | Encrypts the data stream                 |
| Connection Status | Displays the FTPS actions occurring      |



## PASSWORD

Use Password to enter an FTPS password. When you select Password, the FTPS Password QR code screen appears.



Select EDIT to open the FTPS Password editing screen. The password must contain a minimum of 8 characters. The screen displays passwords shorter than 8 characters in a red font.

## PTP

Use PTP to view the precision time protocol status and configure the precision time protocol IP domain.



The settings you can configure for PTP include:

| ITEM       | DETAILS  |
|------------|--|
| PTP State  | Displays the current status of the precision time protocol |
| PTP Domain | Allows you to select the precision time protocol domain    |

## PTP DOMAIN

Use PTP Domain to select the precision time protocol domain for the camera. The camera will only receive precision time protocol communications addressed to the selected IP domain.

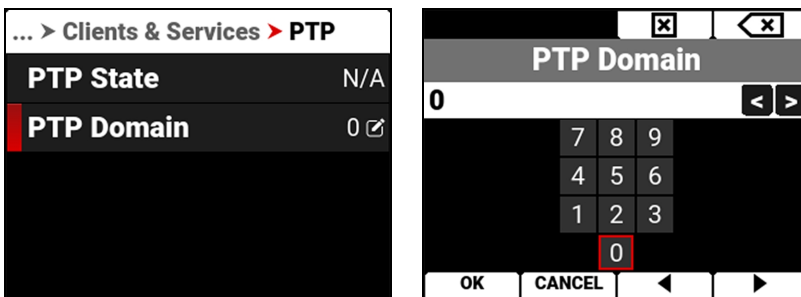

## CLOUD UPLOAD

Use the Cloud Upload menu to configure the cloud upload communications for the camera.

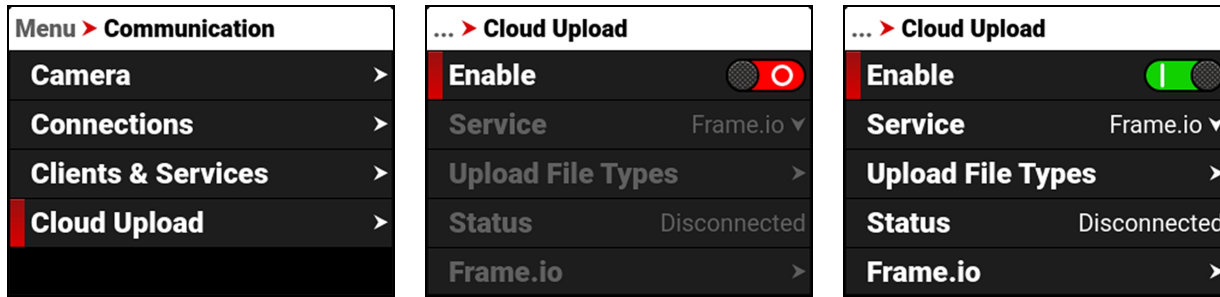

Use the Cloud Upload menu to manage the camera's cloud uploading features:

| ITEM              | DETAILS   |
|-------------------|---|
| Enable            | Enable or disable the Cloud Upload features                         |
| Service           | Select Frame.io or AWS S3 as the cloud upload service               |
| Upload File Types | Enable or disable the uploading of R3D, MOV, WAV, and CDL/LUT files |
| Status            | Displays the status of the cloud connection                         |
| Frame.io          | Configure the Frame.io settings when this service is selected       |
| S3                | Configure the AWS S3 settings when this service is selected         |
| Clips Remaining   | Displays the number of clips remaining to upload                    |
| Time Remaining    | Displays the time remaining to upload                               |
| Upload Remaining  | Displays the size of the remaining upload                           |
| Upload Speed      | Displays the speed of the upload                                    |

## SERVICE

Use Service to select the type of cloud upload service the camera uses.

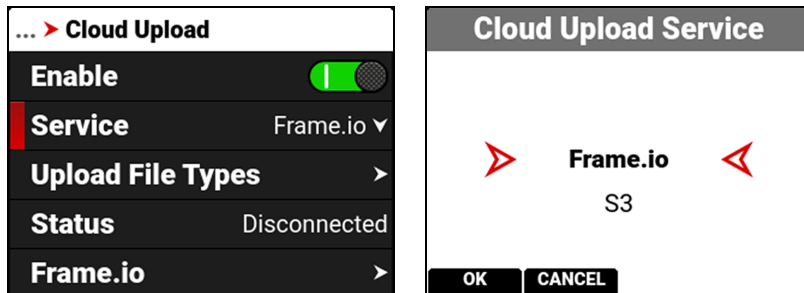

The types of cloud upload services you can select for the camera include:

| ITEM     | DETAILS  |
|----------|--|
| Frame.io | Selects the Frame.io cloud collaboration service |
| S3       | Selects the AWS S3 cloud data management service |

## UPLOAD FILE TYPES

Use Upload File Types to select the file types you want the camera to upload to the cloud.

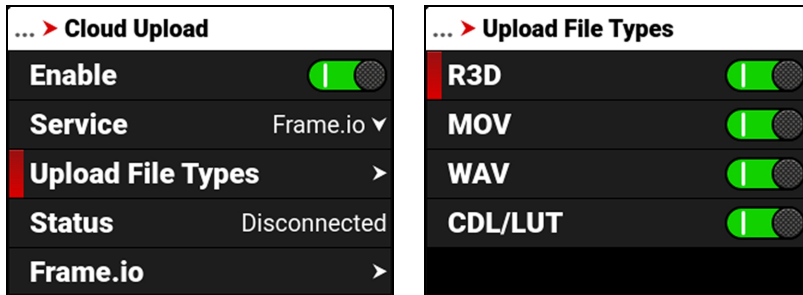

The Upload File Types you can select include:

| ITEM    | DETAILS                           |
|---------|-----------------------------------|
| R3D     | REDCODE RAW video file format     |
| MOV     | ProRes video file                 |
| WAV     | Standard Waveform audio data file |
| CDL/LUT | In camera CDL and LUT files       |

## FRAME.IO

Use Frame.io to connect to, and disconnect from, your Frame.io project.

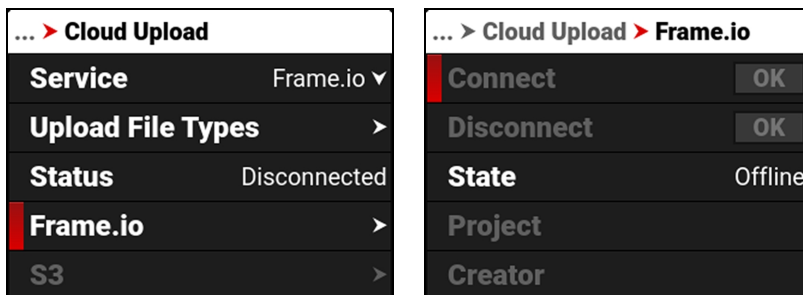

When you select Connect, the screen displays a time sensitive 6-digit code. Use this code to sync the camera to the desired project on the Frame.io website.

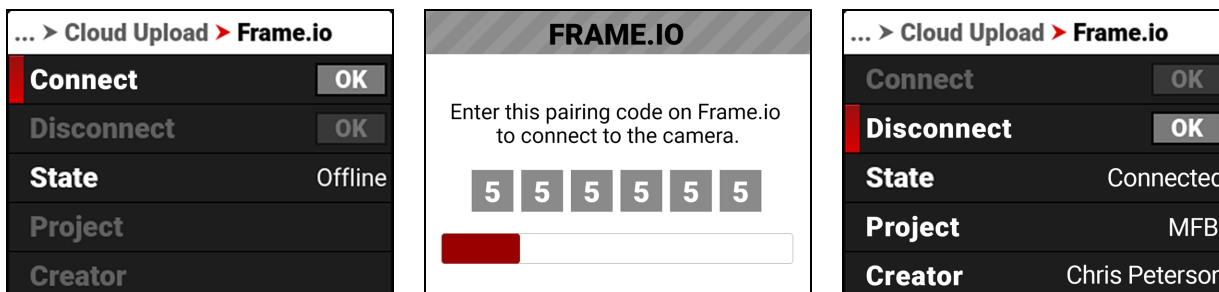

## S3

Use S3 to configure the camera S3 communications.

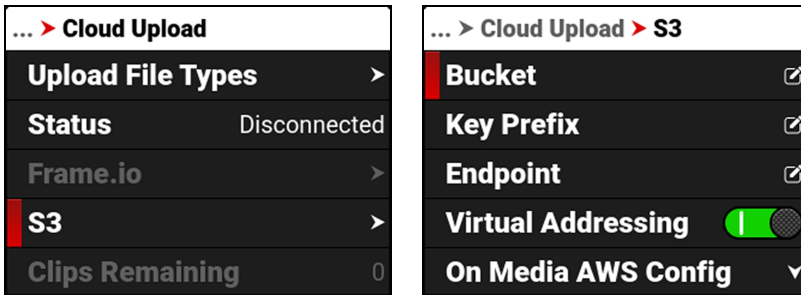

The S3 communications setting you can configure include:

| ITEM                 | DETAILS   |
|----------------------|---|
| Bucket               | Enter the S3 Bucket name                                |
| Key Prefix           | Enter the S3 Key Prefix (optional)                      |
| Endpoint             | Override the the default S3 Endpoint address (optional) |
| Virtual Addressing   | Enable or disable Virtual Addressing                    |
| On Media AWS Config  | Select the AWS configuration stored on the media        |
| In Camera AWS Config | Manage the AWS configurations saved to the camera       |

## BUCKET

Use Bucket to enter the name of the S3 Bucket you want to use to upload your data to the cloud.

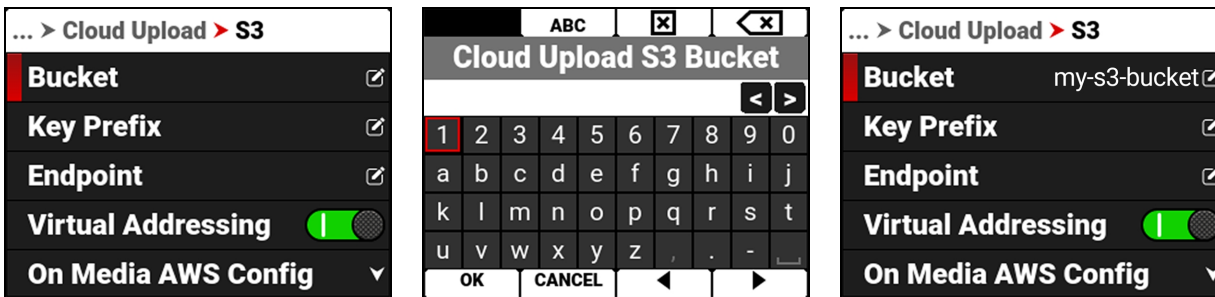

## KEY PREFIX

When specified, the camera adds a prefix to the key (or path) of the uploaded objects to create a subfolder in the bucket (optional).

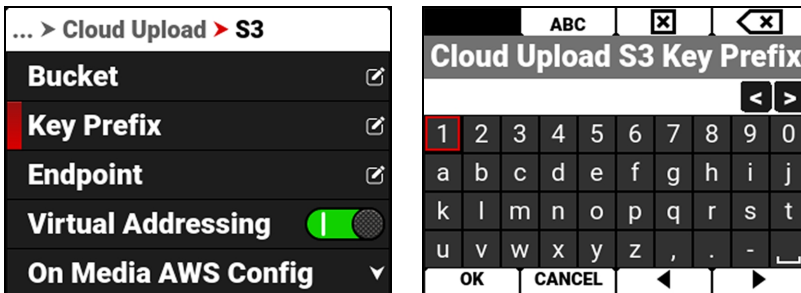

## ENDPOINT

Use Endpoint to override the default S3 endpoint address (optional).

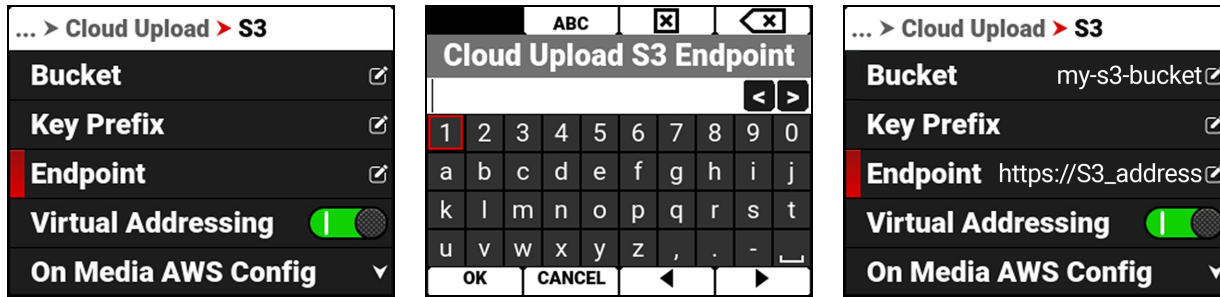

## VIRTUAL ADDRESSING

Virtual Addressing is typically enabled. However, you must disable it when interfacing with some S3-compatible storage. Contact your S3 administrator for more information.

## ON MEDIA AWS CONFIG

Use On Media AWS Config to select an AWS configuration stored on the media card in the aws folder (/aws).

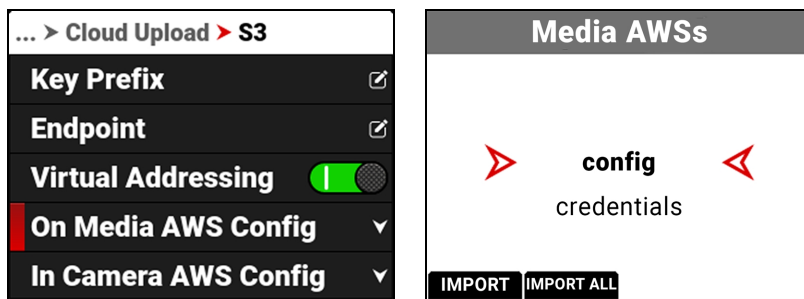

## IN CAMERA AWS CONFIG

Use In Camera AWS Config to export or delete AWS configurations stored on the camera.

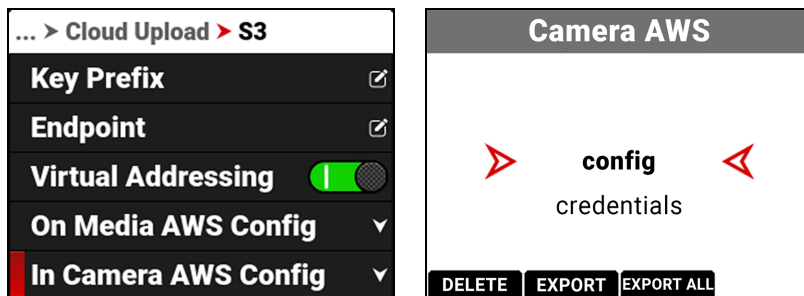

AWS Configuration and Credentials files contain important information for connecting to the AWS bucket, such as region, and access ID / key. AWS CLI tools generate these files when you enter "aws configure". You can also create AWS Configuration and Credentials files manually.

Examples of the AWS configuration and credentials files:

### config:

```
[default]
region = us-west-2
```

### credentials:

```
[default]
aws_access_key_id = AKIAIOSFODNN7EXAMPLE
aws_secret_access_key = wJalrXUtnFEMI/K7MDENG/bPxRfiCYEXAMPLEKEY
```

## SYSTEM SETTINGS MENU

The System Settings menu contains the camera system configuration settings.

From the camera LCD menu, navigate to System Settings and press SEL:

| Menu            |           | Menu > System Settings |       |
|-----------------|-----------|------------------------|-------|
| User Settings   | >         | Date / Time            | >     |
| Autofocus       | >         | Lens                   | >     |
| Communication   | >         | Power                  | >     |
| System Settings | >         | Sensor                 | >     |
| Language        | English ▾ | Side LCD Brightness    | 80% ▾ |

Use the System Settings menu to configure the camera system settings:

| ITEM                | DETAILS   |
|---------------------|---|
| Date / Time         | Date and time settings                                    |
| Lens                | View lens status information and access the Iris menu     |
| Power               | DC and Battery status                                     |
| Sensor              | Flip / Mirror sensor scan and enter Sync Shift values     |
| Side LCD Brightness | Adjust the side LCD brightness                            |
| Indicators          | Enable or disable the record sounds and front Tally LED   |
| GPO Function        | Assign a function to the Extension port GPO pin           |
| Status Settings     | Shutter, aperture, focus, and white balance settings      |
| System Status       | Information about the camera's type, PIN, FW, and runtime |

## DATE / TIME

Use the Date / Time menu to reset the internal clock of the camera. The time and date are timestamped on R3D® files when recording to the media. The camera uses the 24-hour clock convention (military time). For example, enter 2:35 PM as 14:35:00.

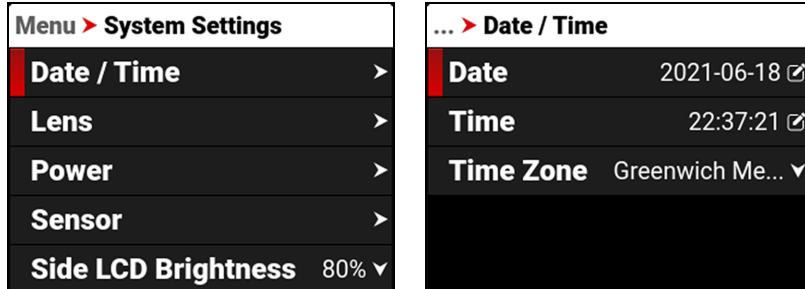

The Date / Time menu items include:

| ITEM      | DETAILS                   |
|-----------|---------------------------|
| Date      | Date in YYYY-MM-DD format |
| Time      | 24-hour format            |
| Time Zone | Global time zones         |

### DATE

Navigate to Date and press SEL to enter the date using the keypad:

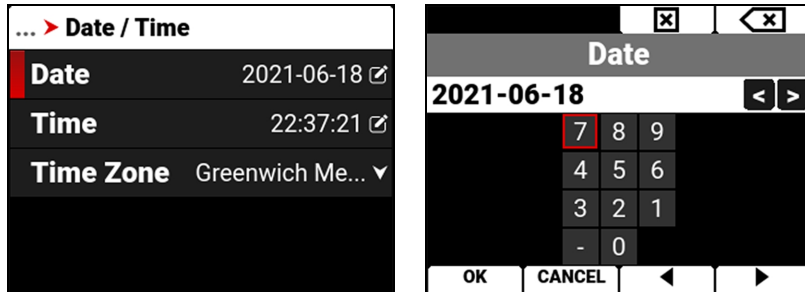

### TIME

Navigate to Time and press SEL to enter the time in 24-hour military format using the keypad:

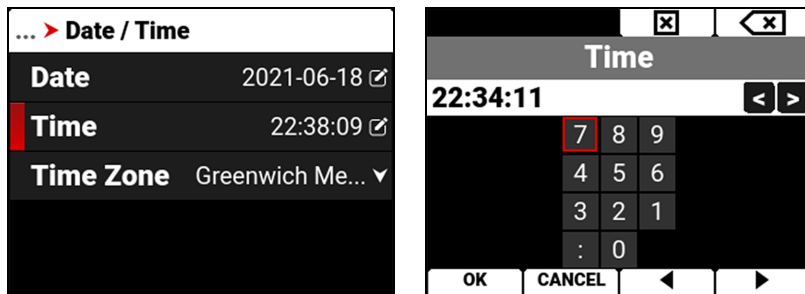

## TIME ZONE

Use Time Zone to select the local time zone for where the camera is located.

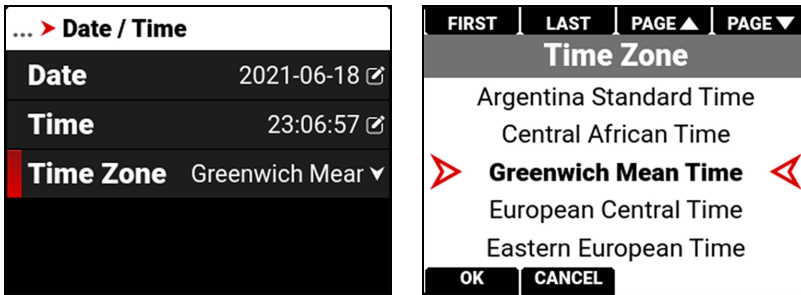

## LENS

Use Lens to view information about the attached lens.

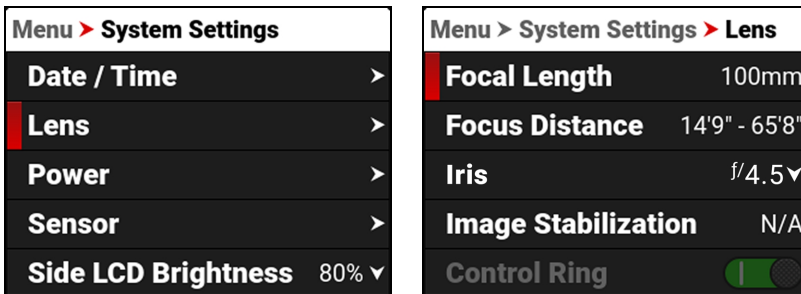

The information you can view from Lens includes:

| ITEM                | DETAILS  |
|---------------------|--|
| Focal Length        | Displays the lens focal length value                   |
| Focus Distance      | Displays the lens focal distance value                 |
| Iris                | Lens Iris menu   |
| Image Stabilization | Displays the lens image stabilization status           |
| i/ Data             | Displays Cooke /i data brand, serial number, and owner |
| Control Ring        | Enable or disable the control ring                     |
| Control Ring Mode   | Select the function the control ring performs          |

## IRIS

Use the Iris menu to select the camera lens f-stop. Press the button below Edit to open the keypad and enter the f-stop manually.

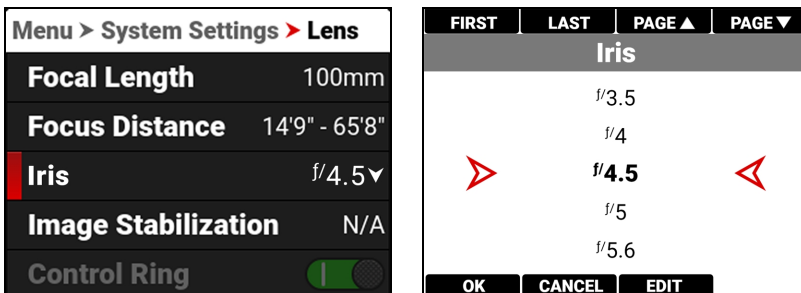



## CONTROL RING MODE

When the Control Ring feature is supported by the lens and is enabled, you can select the camera setting you want to use the Control Ring to adjust.

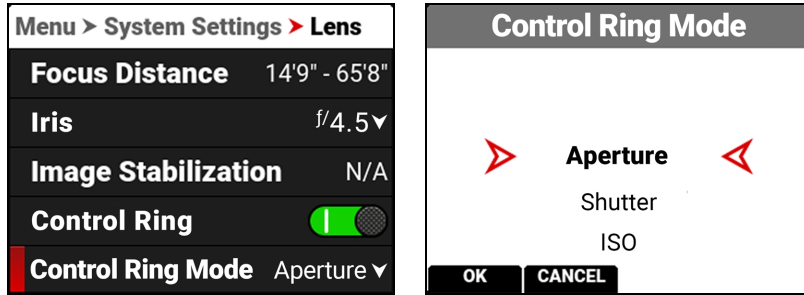

The modes you can select include Aperture (Iris, default), **Shutter**, **ISO**, **White Balance**, LCD Magnify, SDI Magnify, LCD+ SDI Magnify, False Color Cycle, Peaking Cycle, and Tools Cycle.

## POWER

Use the Power menu to view the various camera power status indicators.

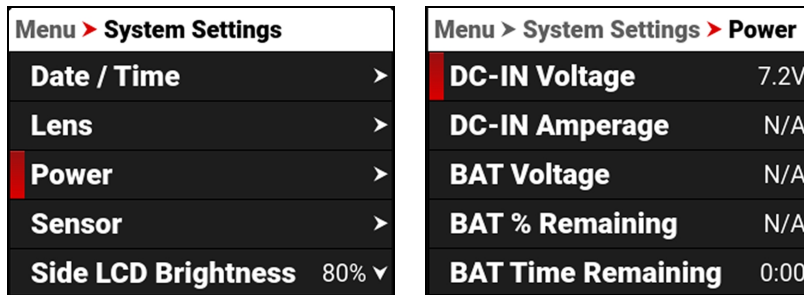

The Power indicators you can view include:

| ITEM               | DETAILS   |
|--------------------|---|
| DC-IN Voltage      | When DC is connected, this displays the DC voltage                                      |
| DC-IN Amperage     | When DC is connected, this displays the DC amps   |
| BAT Voltage        | When a battery is connected, this displays the battery voltage                          |
| BAT % Remaining    | When a compatible battery is connected, this displays the % of battery charge remaining |
| BAT Time Remaining | When a battery is connected, this displays the camera operating time remaining          |
| BAT Amperage       | When a battery is connected, this displays the battery amps                             |
| Power Out          | Enables or disables the 5 V / 500 mA power to the <b>Extension Port</b>                 |

## SENSOR

Use Sensor to flip / mirror the sensor scan and to shift the sync signal.

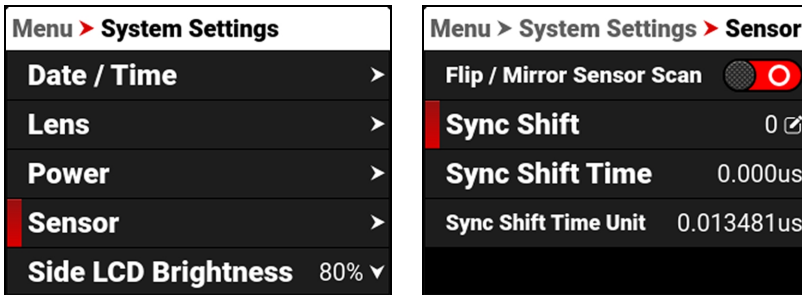

The Sensor menu includes:

| ITEM                      | DETAILS   |
|---------------------------|---|
| Flip / Mirror Sensor Scan | Toggle to Flip / Mirror the sensor scan <sup>1</sup>                    |
| Sync Shift                | Enter the desired amount of sync shift                                  |
| Sync Shift Time           | Displays the Sync Shift time in microseconds (µs)                       |
| Sync Shift Time Unit      | Displays the units of microseconds (µs) used for the Sync Shift setting |

1. Always recalibrate the camera after changing the sensor scan orientation.

## SYNC SHIFT

Use Sync Shift to open the keypad and enter the number of Sync Shift Time Units you want to offset the sensor from the external sync signal. Use this setting to resolve synchronization issues on set such as when working with LED Volumes.

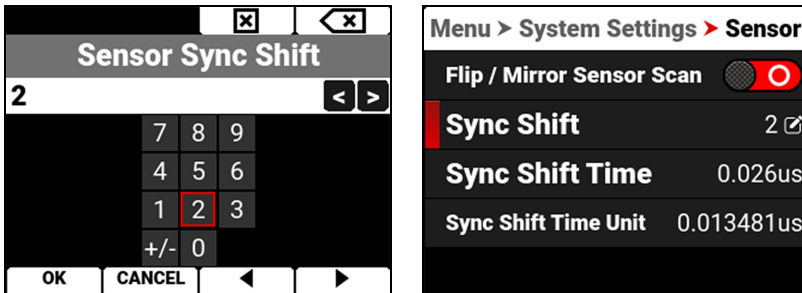

In this example, the Sync Shift is 2 x 0.013481 microseconds ≈ 0.026 microseconds.

## INDICATORS

Use the Indicators menu to enable or disable the tally light and the REC button sounds, and to select which sounds the REC button makes.

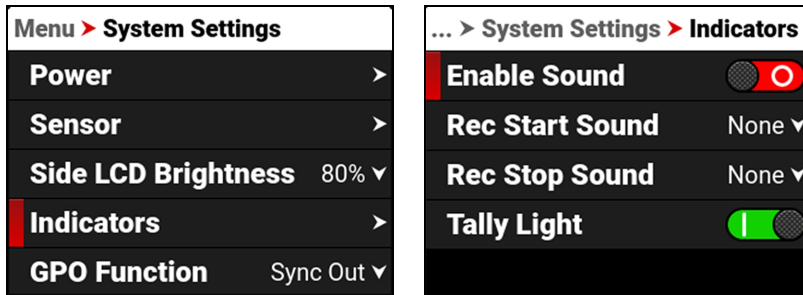

### ENABLE SOUND

Use Enable Sound to enable the REC button sounds.



### REC START SOUND

Use Rec Start Sound to select the sound the speaker emits when the REC button is pressed to start recording.

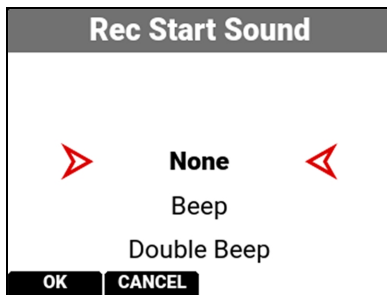

The selections include:

- None
- Beep
- Double Beep
- Beep Ascending
- Beep Descending
- Money
- Shutter

### REC STOP SOUND

Use Rec Stop Sound to select the sound the speaker emits when the REC button is pressed to stop recording.

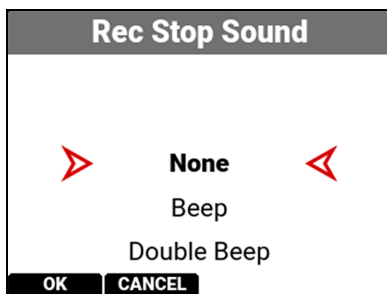

The selections include:

- None
- Beep
- Double Beep
- Beep Ascending
- Beep Descending
- Money
- Shutter

### TALLY LIGHT

Use Tally Light to enable the tally indicator LED (refer to the LED section of [Camera Body](#)).



## GPO FUNCTION

Use the GPO Function menu to select the GPO function of the Extension port.

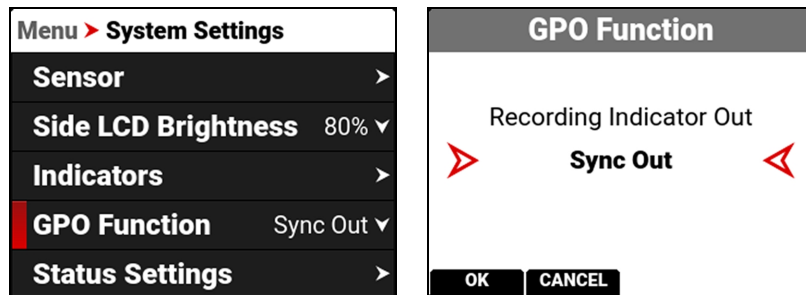

You can select the following GPO functions for the Extension port:

- Recording Indicator Out (Tally)
- Sync Out

## RECORDING INDICATOR OUT

The Recording Indicator Out function sends a 3.3 V ( 0.04 A max) tally signal out of the Extension port GPO pin to the Ground pin when the camera is recording. The rising edge of the signal pulse indicates the start of record, and the falling edge represents the end of record.

## SYNC OUT

The Sync Out function sends a 3.3 V (0.04 A max) pulse at start of each frame, matching the recording frame rate.

For more information, refer to [Extension Port](#).

## STATUS SETTINGS

Use the Status Settings menu to select the shutter display mode, aperture increments, focus distance units, and white balance units displayed in the camera's menus.

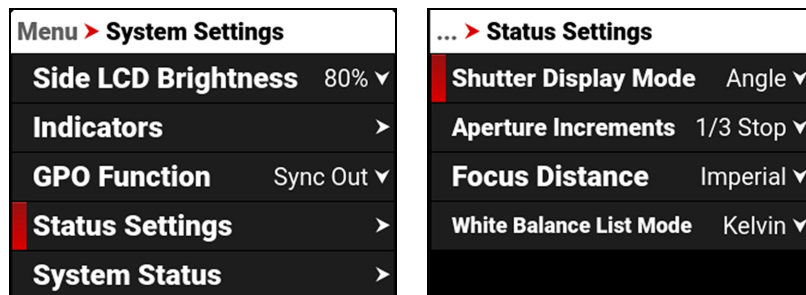

The Status Settings that you can configure include:

| ITEM                                    | DETAILS  |
|---|--|
| <a href="#">Shutter Display Mode</a>    | Select a time-fraction or an angle for the shutter menu display unit |
| <a href="#">Aperture Increments</a>     | Select 1/4 or 1/3 f-stop increments                                  |
| <a href="#">Focus Distance</a>          | Select the focus distance units (Metric or Imperial)                 |
| <a href="#">White Balance List Mode</a> | Select Kelvin or White Balance presets                               |

## SHUTTER DISPLAY MODE

Use Shutter Display mode to select the way that the camera displays the **Shutter** setting in the menu.

When select Angle, the **Shutter** menu displays the choices in degrees. When you select Time, the Shutter menu displays the choices in fractions of a second.

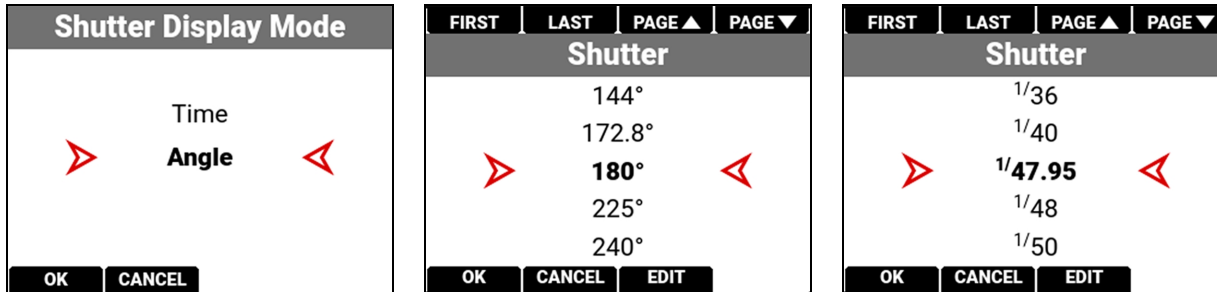

## APERTURE INCREMENTS

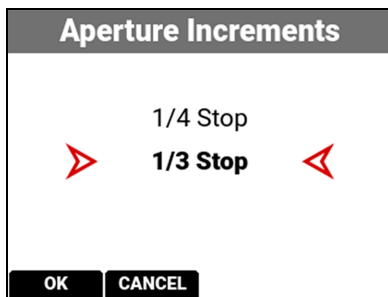

Use Aperture Increments to select one fourth increments or one third increments for the camera f-stop settings. The default is 1/3 Stop.

## FOCUS DISTANCE

Use Focus Distance to select Imperial or Metric units for the **Lens** Focus Distance display. The default is Imperial.

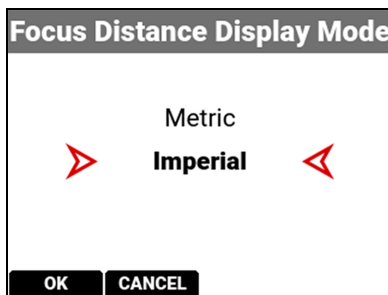

## WHITE BALANCE LIST MODE

Use White Balance List Mode to select Kelvin or Presets for the White Balance Color Temperature menu. The default is Kelvin.

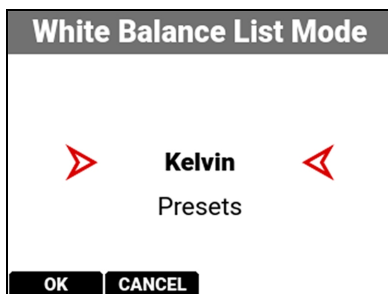

## SYSTEM STATUS

Use the System Status menu to view camera information and to view temperature readings.

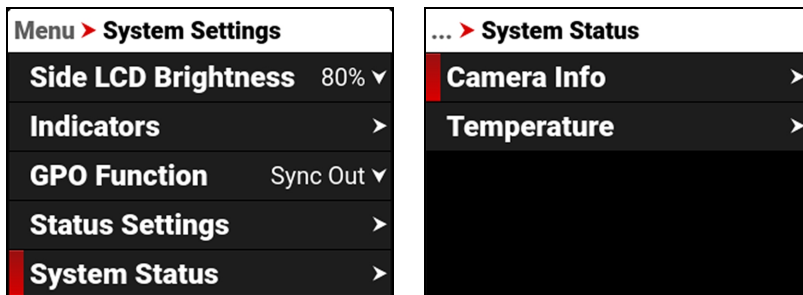

The system status information you can view includes:

| ITEM        | DETAILS             |
|-------------|---------------------|
| Camera Info | Camera information  |
| Temperature | Camera temperatures |

## CAMERA INFO

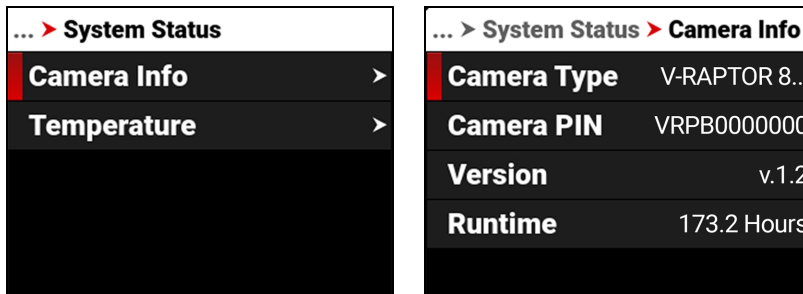

The camera information you can view includes:

| ITEM        | DETAILS  |
|-------------|--|
| Camera Type | Displays the camera description                              |
| Camera PIN  | Displays the camera personal identification number (PIN)     |
| Version     | Displays the firmware version number installed on the camera |
| Runtime     | Displays the total number of hours that the camera has run   |

## TEMPERATURE

|                            |  |
|----------------------------|--|
| ... > <b>System Status</b> | ... > <b>Temperature</b>                                     |
| <b>Camera Info</b> >       | <b>Camera Status</b> <span style="color: green;">Good</span> |
| <b>Temperature</b> >       | <b>Logic Board 0</b> 60°C                                    |
|                            | <b>Logic Board 1</b> 60°C                                    |
|                            | <b>Power Board</b> 30°C                                      |
|                            | <b>STM</b> 30°C  |

The camera temperatures you can view include:

| ITEM                    | DETAILS  |
|-------------------------|--|
| Camera Status           | Displays Good (green) or Overheating (yellow)          |
| Logic Board 0           | Displays the Celsius temperature of Logic Board 0      |
| Logic Board 1           | Displays the Celsius temperature of Logic Board 1      |
| Power Board             | Displays the Celsius temperature of the power IC board |
| STM                     | Displays the Celsius temperature of the power STM IC   |
| Sensor                  | Displays the Celsius temperature of the sensor         |
| Calibration Temperature | Temperature at which the sensor was calibrated         |

## LANGUAGE MENU

The Language menu contains the languages you can select for the user interface (UI).

From the camera LCD menu, navigate to Language and press SEL:

|                           |                         |
|---------------------------|-------------------------|
| <b>Menu</b>               | <b>Language</b>         |
| <b>Autofocus</b> >        | <b>English</b> <>       |
| <b>Communication</b> >    | Simplified Chinese      |
| <b>System Settings</b> >  | French                  |
| <b>Language</b> English ▾ | <b>OK</b> <b>CANCEL</b> |
| <b>Maintenance</b> >      |                         |

The languages you can select include:

- English
- Simplified Chinese
- French
- German
- Japanese
- Spanish

## MAINTENANCE MENU

The Maintenance menu contains the settings you use to perform various maintenance tasks on your camera. From the camera LCD menu, navigate to Maintenance and press SEL:

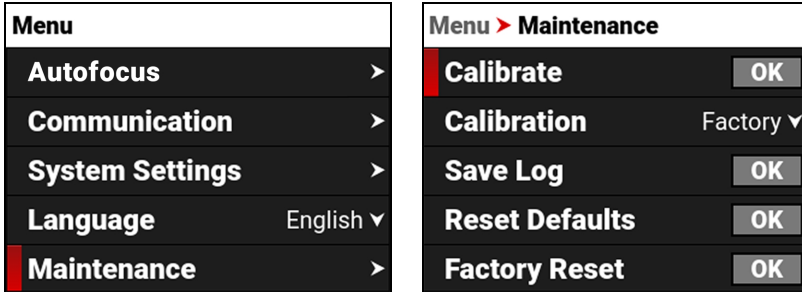

Use the Maintenance menu to perform the following camera maintenance tasks:

| ITEM           | DETAILS  |
|----------------|--|
| Calibrate      | Performs the selected Calibration                    |
| Calibration    | List of calibration options                          |
| Save Log       | Saves the camera log files to the media              |
| Reset Defaults | Resets the camera settings to their default settings |
| Factory Reset  | Restores the camera to the factory settings          |
| Upgrade        | Updates the firmware                                 |

## CALIBRATE

Use Calibrate to start the camera calibration process and create your User calibration profile.

Only calibrate the camera after it has reached its operational temperature. This occurs usually within five minutes after you turn on the camera in the filming environment. Do not calibrate immediately after powering on.

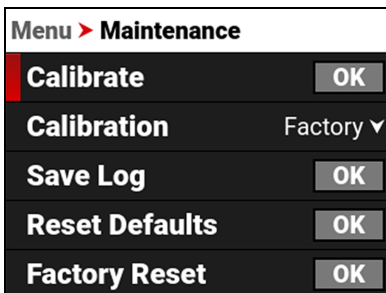

**NOTE:** Make sure that the mount cap is installed on the camera before you calibrate the camera.

Press the button below OK to begin calibrating the camera.

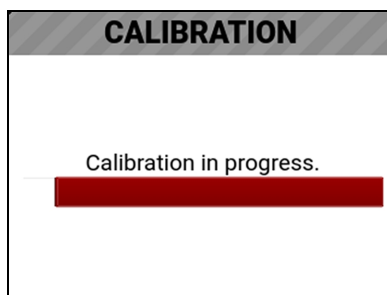
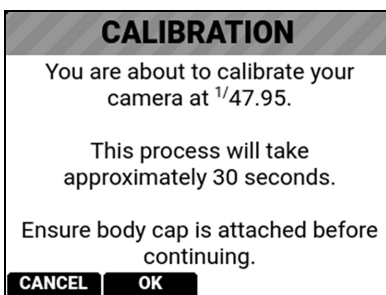



When the camera is finished calibrating, the LCD displays the Calibration status message:

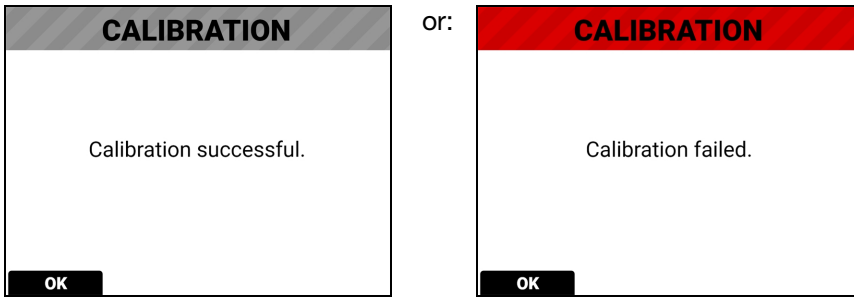

## CALIBRATION

Use Calibration to select the active camera Calibration.

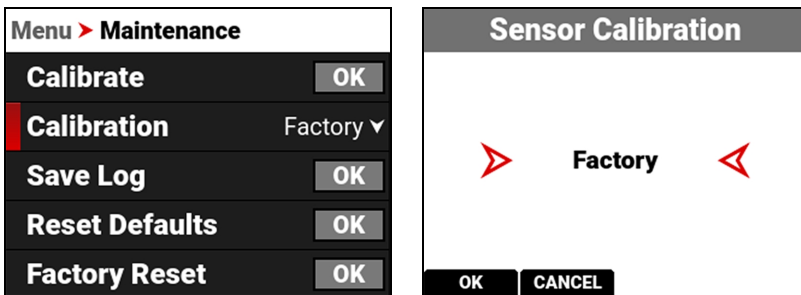

You should always select User calibration. The first time you calibrate the camera, the only choice is Factory. After you perform a calibration, the User calibration profile is added to the list and the camera makes it the default calibration. Every time you calibrate the camera, the User profile is updated. The only time the User profile is removed, is when you perform a Factory Reset.

If User calibration is not available, the camera defaults to Factory calibration. Calibrate the camera to generate a new User calibration profile.

## SAVE LOG

Use Save Log to save the camera log to the media.

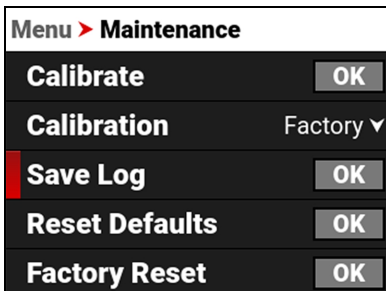

When the media is full, or missing, the camera will display an error message. When there is no error, the success message is displayed.

Error:

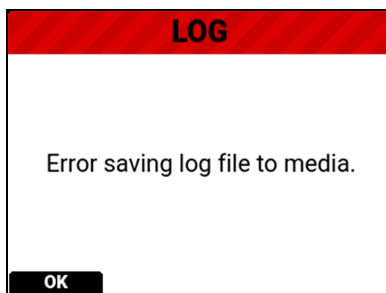

Success:

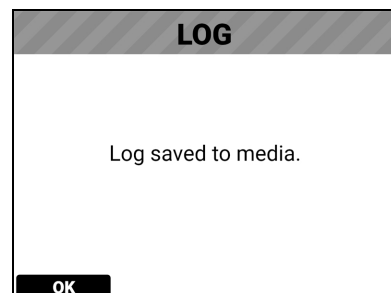

## RESET DEFAULTS

Use Reset Defaults to reset the camera to the factory default menu settings.

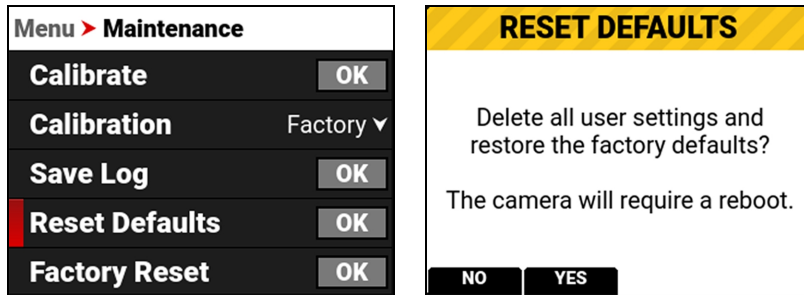

**NOTE:** Resetting the camera will delete all of your menu settings.

**NOTE:** The camera turns off, and then back on to complete the reset process.

Press the button under Yes to reset the camera menus to the default settings.

## FACTORY RESET

Use Factory Reset to reset the camera to the factory settings.

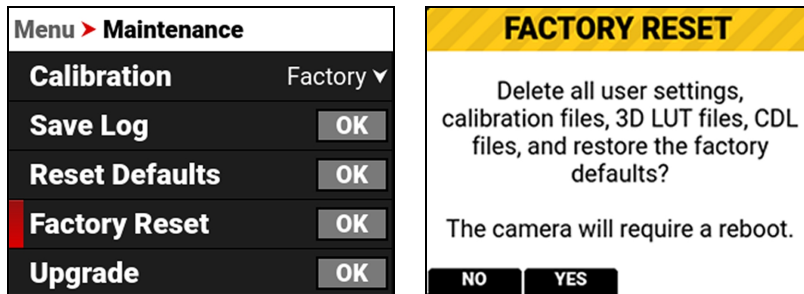

**NOTE:** Resetting the camera will delete all of your settings and remove all imported files. The camera turns off, and then back on to complete the reset process.

Press the button under Yes to reset the camera to the factory settings.

## UPGRADE

Use Upgrade to perform a camera firmware update.

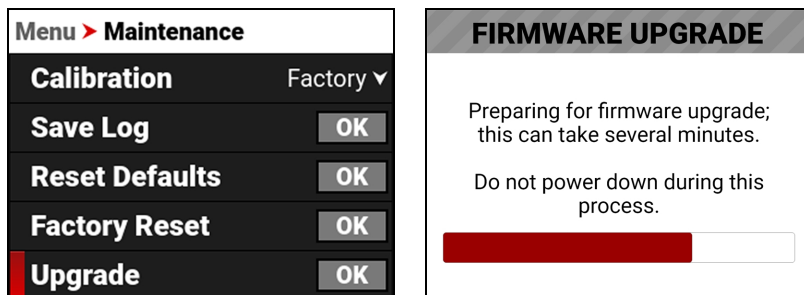

For more information about upgrading the firmware, refer to [Upgrading the Firmware](#).

## 5. HOW-TO

This section describes how you can use the camera features.

### WI-FI CONFIGURATION

The camera offers a wireless (802.11g) connection that provides communication support for third-party applications. As with all wireless devices, the communication range varies with the environment and any radio frequency (RF) interference that may be present. You can select a wireless frequency of 2.4 GHz or 5 GHz. For optimal performance, do not obstruct the antenna with any accessory, mounting plate, or mounting rail.

The camera uses **Ad-Hoc** mode to set up the camera as a Wi-Fi hot spot.

The camera uses **Infrastructure** mode to connect to existing Wi-Fi infrastructure.

### CONNECTING WIRELESSLY TO AN EXISTING WI-FI NETWORK

This camera uses the WPA2 Wi-Fi protocol.

1. Navigate to the Wi-Fi menu **MENU > COMMUNICATION > Wi-Fi**.

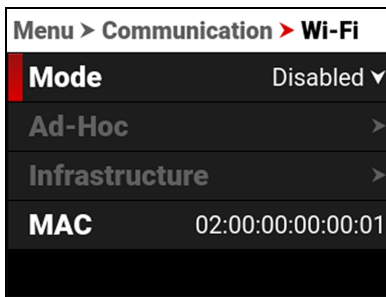

2. From the Mode option, select Infrastructure.

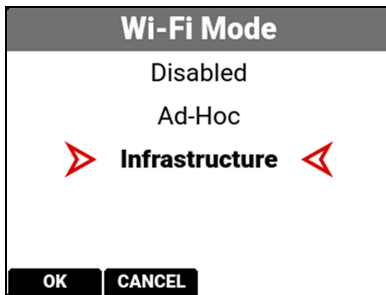

3. From the Infrastructure menu, select Networks.

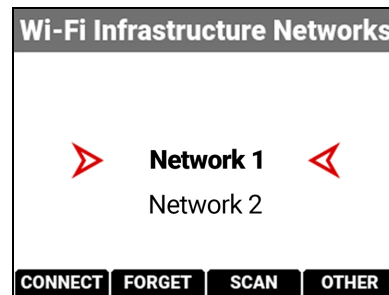
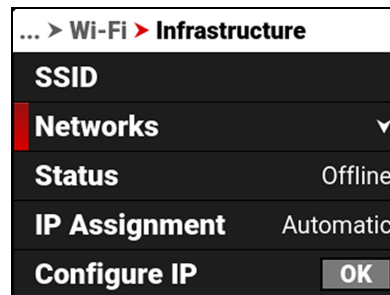
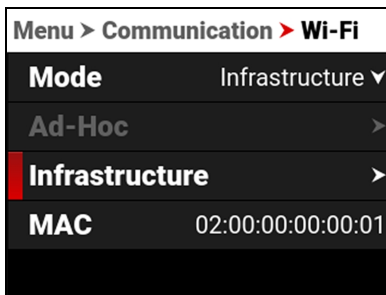

4. Select the network name from the Networks list menu:

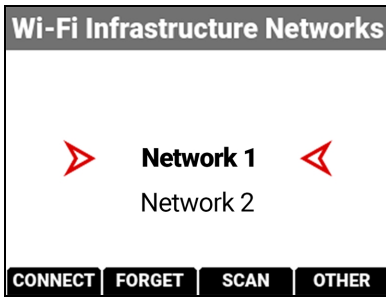

or press the button under SCAN to scan for available networks and update the Networks list:

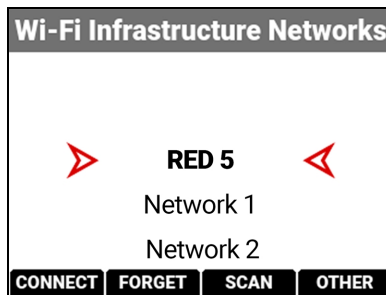
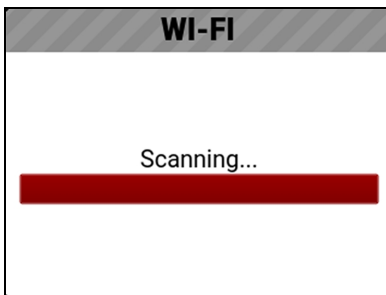

5. Press the button under CONNECT. The CONNECT screen displays:

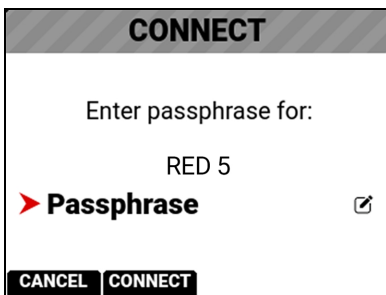

6. Press SEL. The Passphrase entry screen displays:

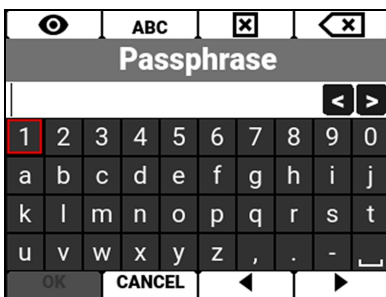

7. Enter the passphrase for the selected network. The passphrase is case sensitive and it must use a minimum of 8 characters. The OK button is enabled after entering 8 characters.

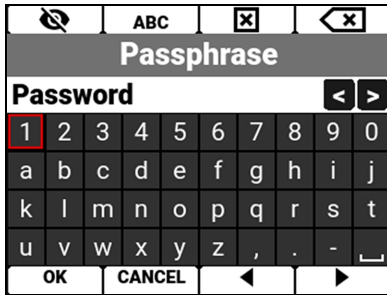

8. Press the button below OK on the completed Passphrase entry screen. The completed CONNECT screen displays.



9. Press the button under CONNECT. The camera connects to the selected network:

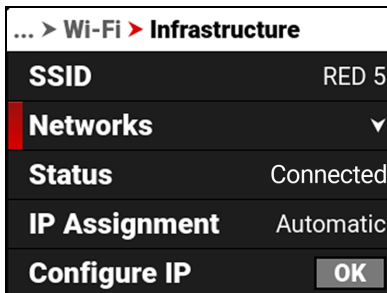

## FTPS CONFIGURATION

The File Transfer Protocol Secure (FTPS) offers a fast and secure system for transferring data to and from the camera. FTPS is available when the camera is enabled and connected to a network over Wi-Fi or through the USB-C port to an Ethernet adapter.

The settings for using FTPS on the camera include:

- **Protocol:** FTP or FTPS
- **Host:** [IP ADDRESS OF THE CAMERA]
- **Port:** 21
- **Encryption:** TLS/SSL Explicit encryption
- **Username:** [USERNAME IN FTPS MENU SETTINGS]
- **Password:** [PASSWORD IN FTPS MENU SETTINGS]
- **Logon Type:** Normal

### NOTE:

- File transfer speeds may vary depending on the strength of the signal (when using Wi-Fi) and the amount of network traffic. For the fastest and most reliable data transfer, we recommend using a hard-wired connection.
- Steps may differ depending on which FTP software you wish to use, consult your software's user guide for additional assistance.
- When setting up FTP, make sure you use FTP or FTPS and not SFTP as these are different protocols.
- For security reasons, the FTPS host name and password are only displayed on the camera FTPS menu.
- Disabling encryption can increase transmission speeds.

## CAMERA SET-UP

1. Connect your camera to the network with the desired connection method (Ad-Hoc, Infrastructure or USB-C) and verify the connection. A successful connection is confirmed when the camera displays "Connected" in the Wi-Fi Status:

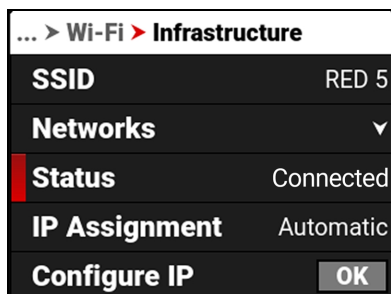

2. Navigate to Menu > Communication > FTPS. Take note of the username and password. You can also enter a new password.

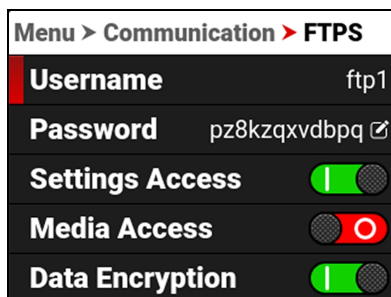

3. Enable the user permissions by toggling Settings or Media to the on or off position. The media folder will display as an empty folder on the FTP App when Media Access is disabled (off).
4. The camera is now set-up on FTPS.

## SOFTWARE SET-UP (FILEZILLA)

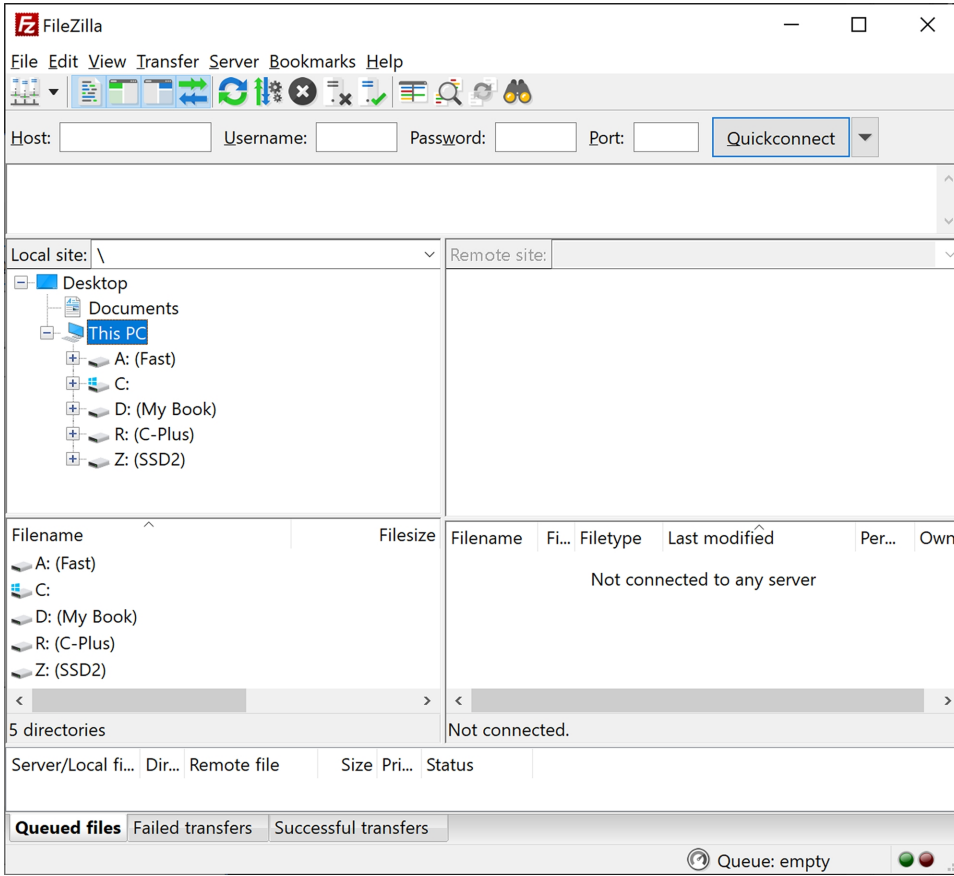

1. In FileZilla, enter the following settings:

- Host: *ftp://Camera's IP Address* - Example: *ftp://192.168.1.93*
- Username: Username displayed in FTPS menu
- Password: Password displayed in FTPS menu
- Port: leave blank

2. Click on Quickconnect . Depending on the permissions you will now have access to the desired folders.

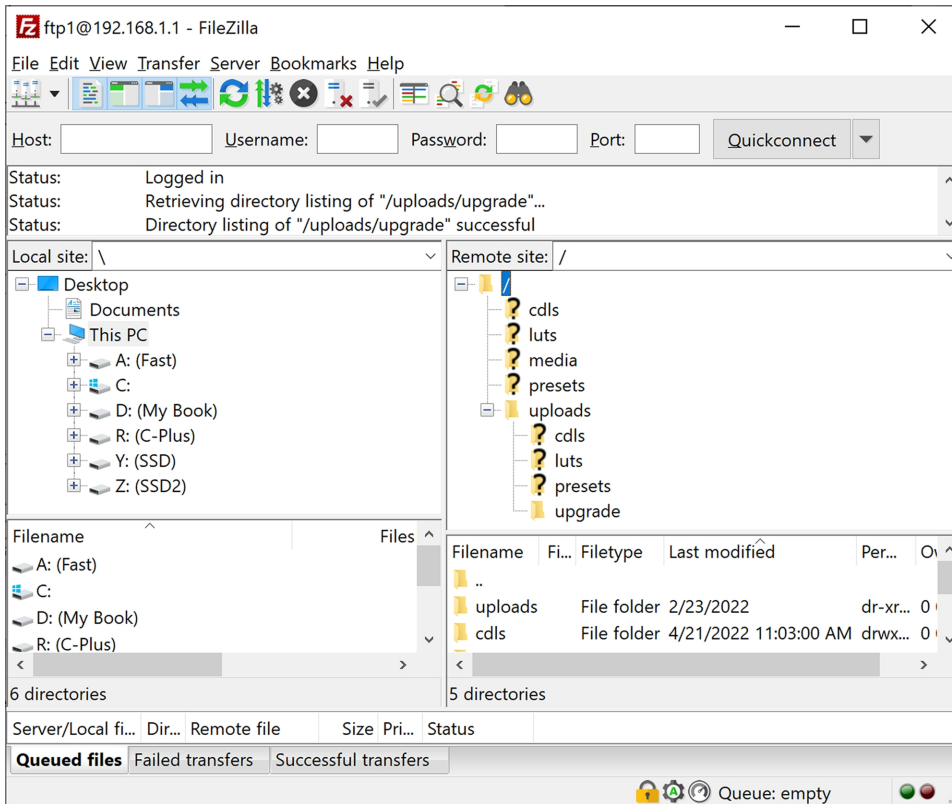

The camera FTPS menu Connection Status displays Connected:

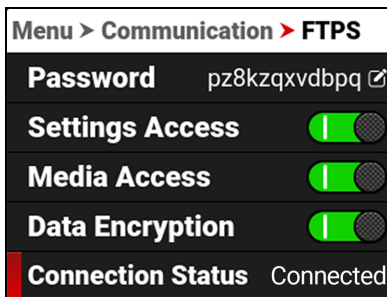

## ADDITIONAL INFORMATION

When uploading files to the camera, make sure that you use the 'upload' folder & then the desired sub-directory of cdl's, luts, presets, or upgrade. Media cannot be uploaded to the camera folders.

The data rate of the FTPS transfer with encryption maxes out at roughly Gigabit Ethernet speeds.

Estimated download time for a full 256 GB is approximately 47 minutes when using a wired connection.



## USB-C CONFIGURATION

The RED V-RAPTOR 8K S35 offers a USB-C 3.0 protocol connection that provides communication support for Android devices, Apple devices, Ethernet devices, and R3D streaming over RED Connect License (with 5 Gb/s Ethernet adapter).

For more information about RED Connect refer to: [RED Connect](#).



This section includes instructions for:

- [USB-C Android Configuration](#)
- [USB-C Apple Configuration](#)
- [USB-C Ethernet Configuration](#)

## USB-C ANDROID CONFIGURATION

The RED V-RAPTOR 8K S35 offers a USB-C 3.0 protocol connection that provides communication support for Android devices.

### CONNECTING TO AN ANDROID DEVICE

1. From the Google Play store, download the **RED Control App** to the Android device.



2. Connect the Android device to the camera with a USB-C cable.

3. Open the Android device settings by tapping the Settings icon (gear).



## 4. Select Connections.

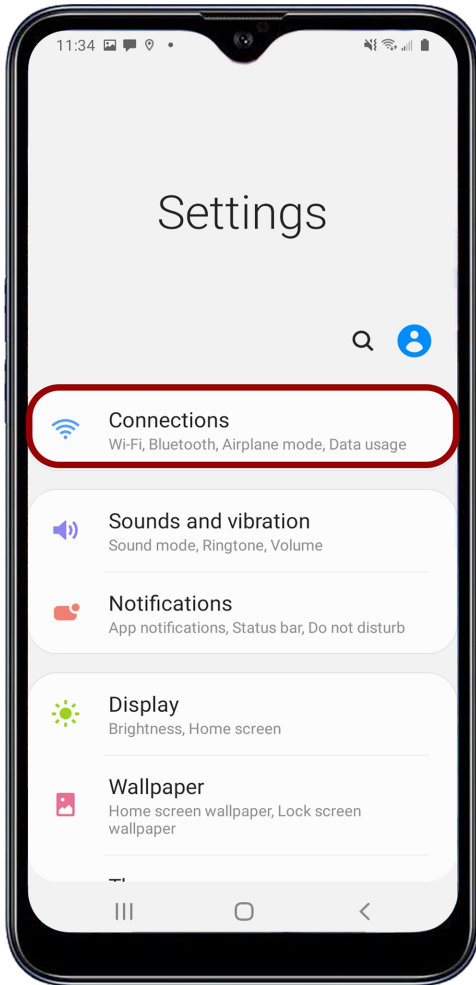

## 5. Select Mobile Hotspot and Tethering.

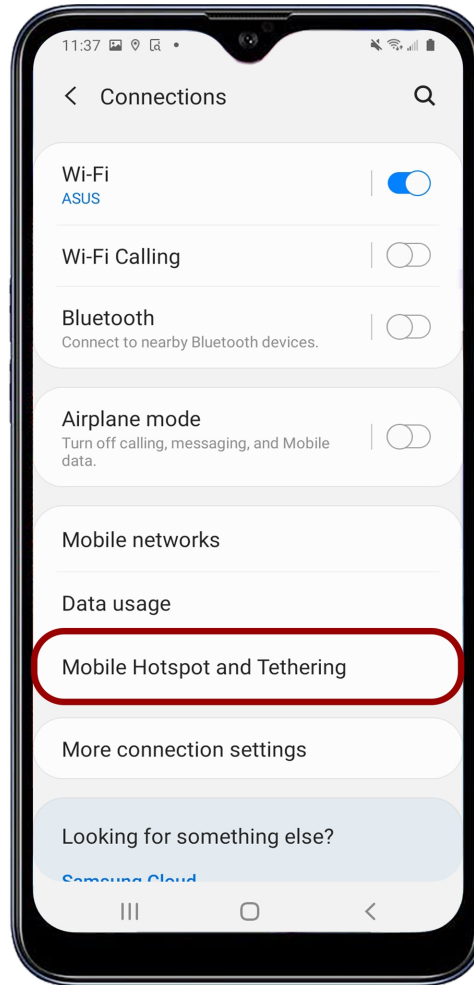

**NOTE:** Mobile Hotspot and Tethering is only available on Android devices with cellular capability.

## 6. Enable USB Tethering.

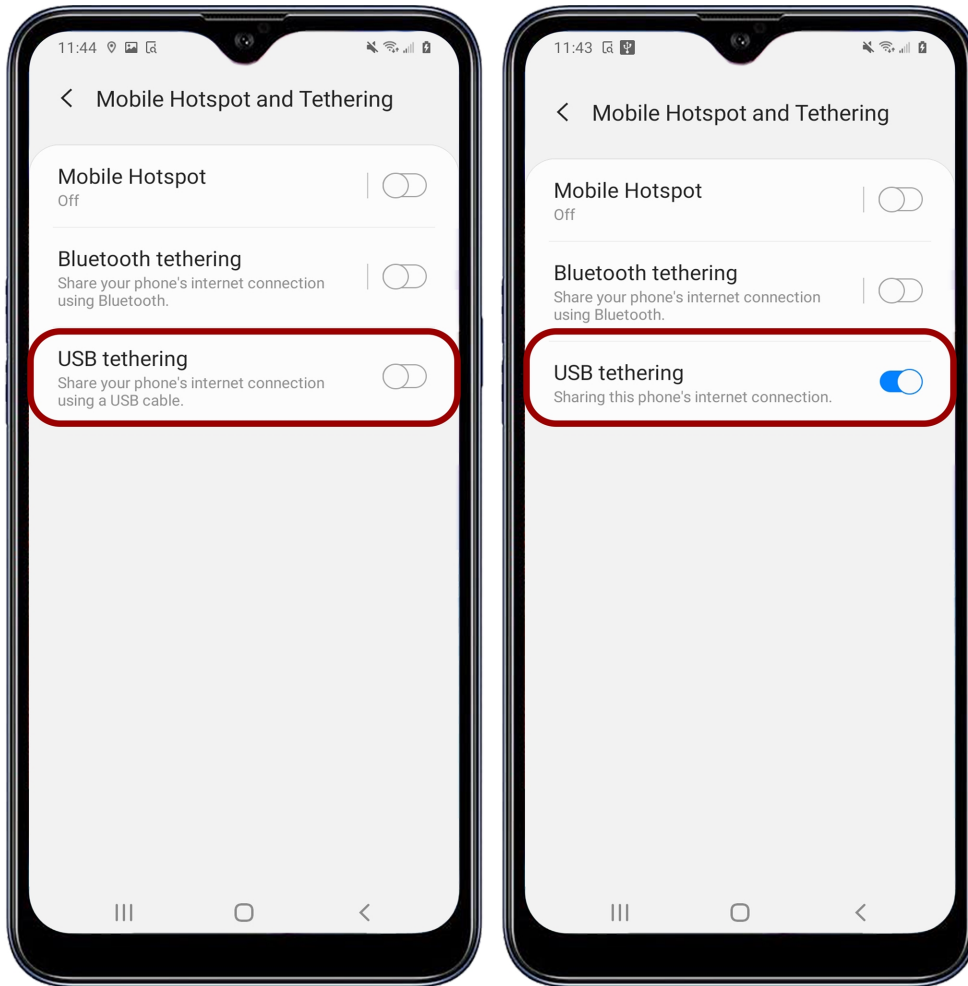

7. From the Android device, tap the RED Control icon to open the RED Control app.



The RED Control app displays the camera connection icon.

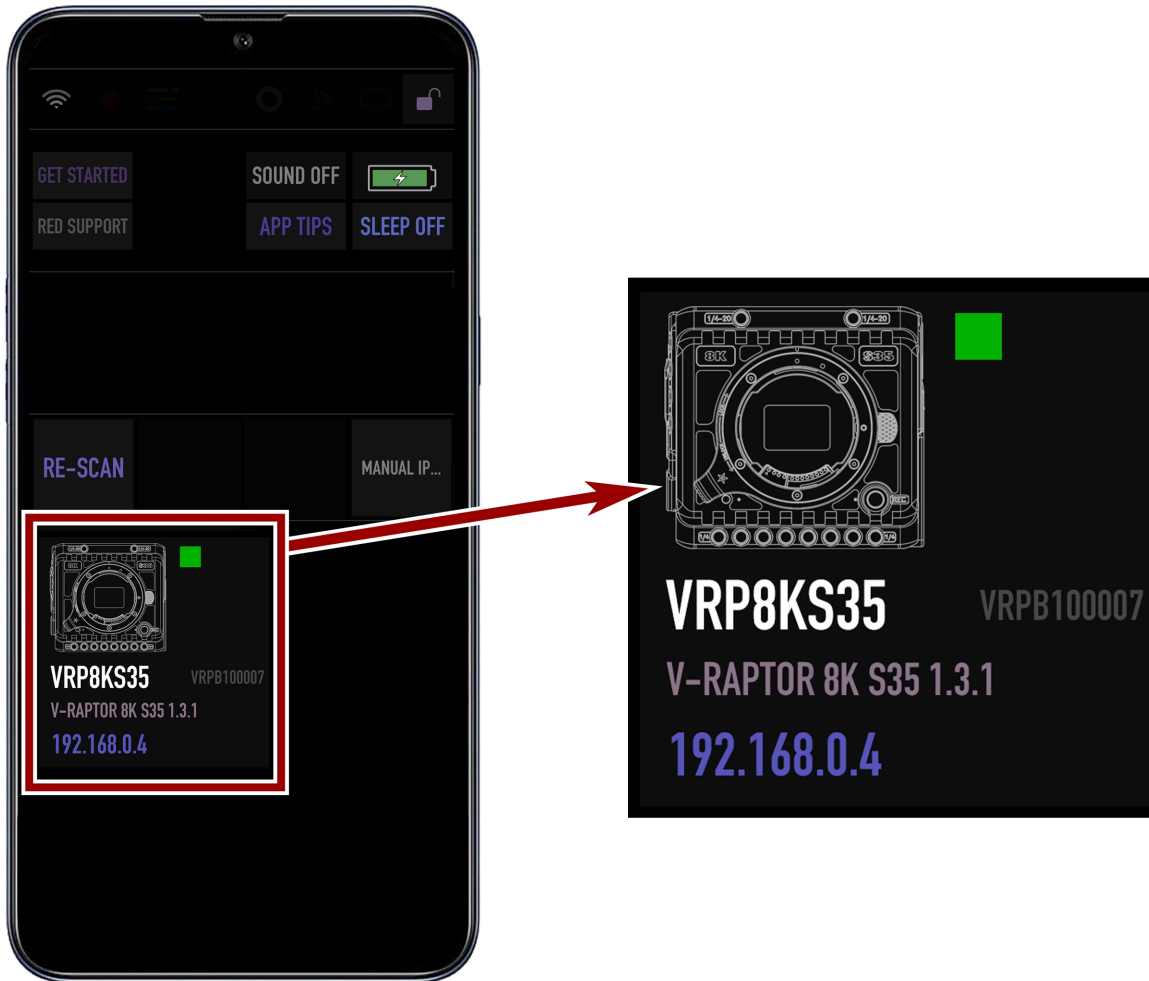

8. Tap the icon to open the RED Control app tools for the tethered camera.

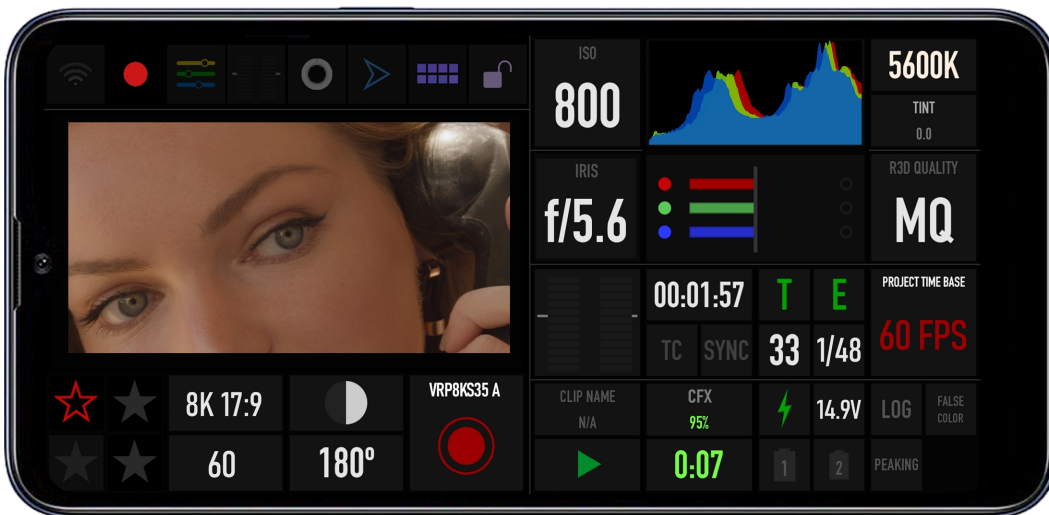

From here you can use the RED Control App to monitor and control the camera.

## USB-C APPLE CONFIGURATION

The V-RAPTOR 8K S35 offers a USB-C 3.0 protocol connection that provides communication support for Apple devices.

### CONNECTING TO AN APPLE DEVICE

1. From the Apple store, download the **RED Control App** to the Apple device.

**Note:** Scroll to the bottom of the user agreement to accept the agreement.



2. Connect the Apple device to the camera with a USB-C cable. If the "Trust This Computer?" message displays, skip to step 6.



3. Open the Apple device settings by tapping the Settings icon.



## 4. Select Personal Hotspot.

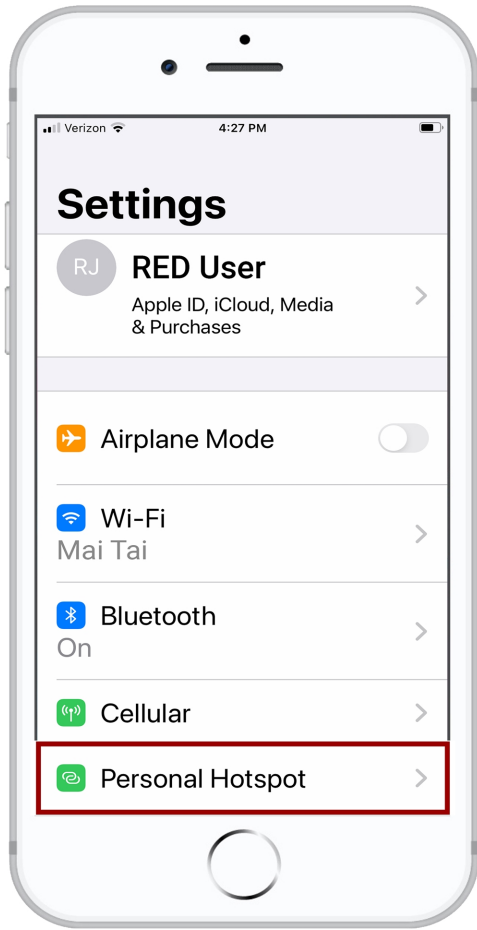

## 5. Allow others to join.

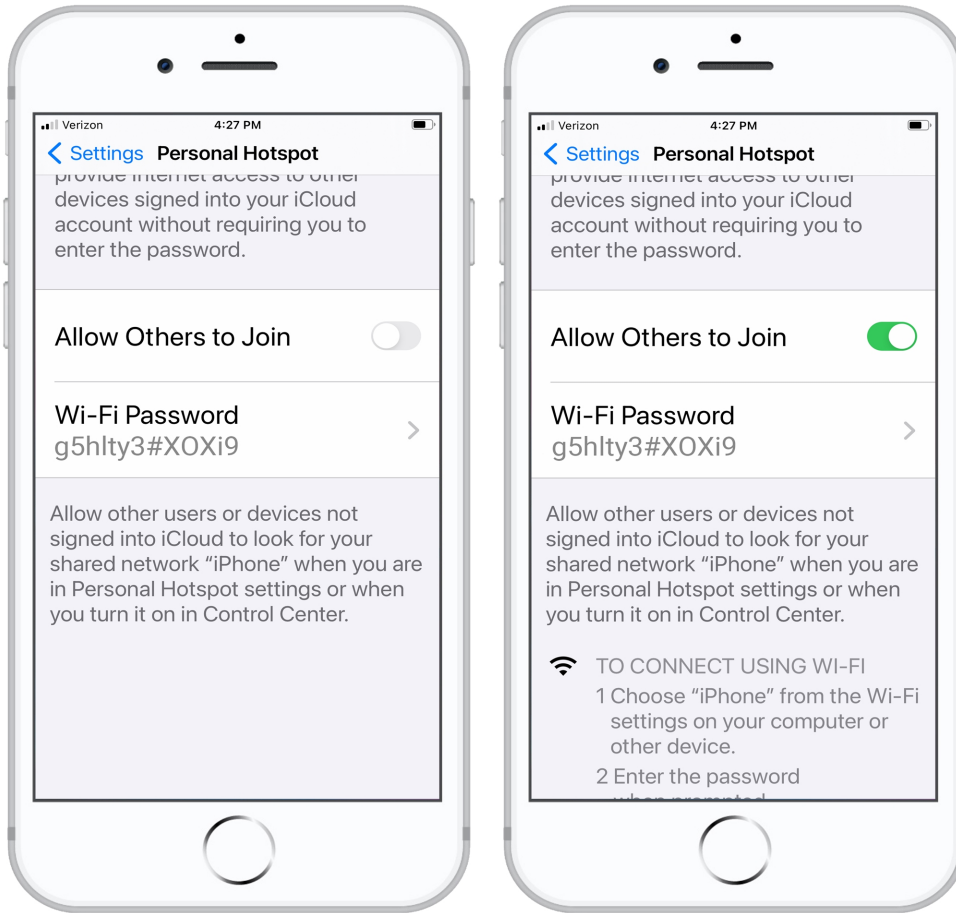

6. The Apple device prompts you to acknowledge that you trust the computer (camera).

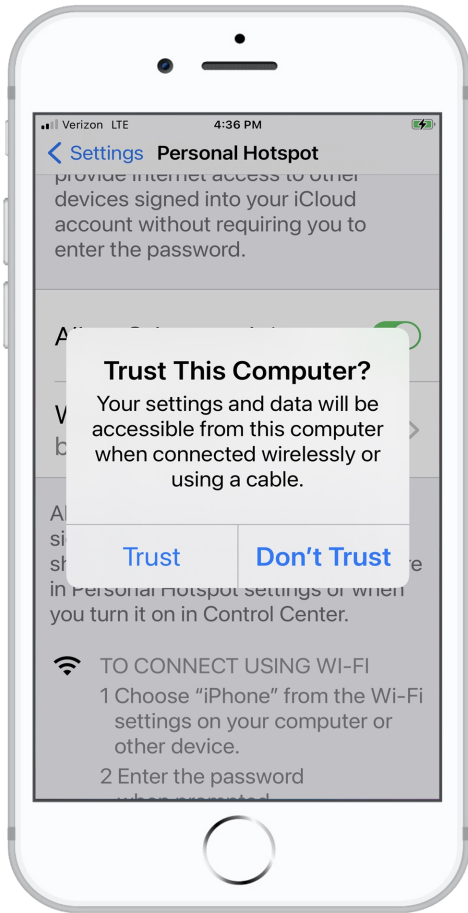

7. From the Apple device, tap the RED Control icon to open the RED Control app.



The RED Control app displays the camera connection icon. The word LINK is visible after the IP address.

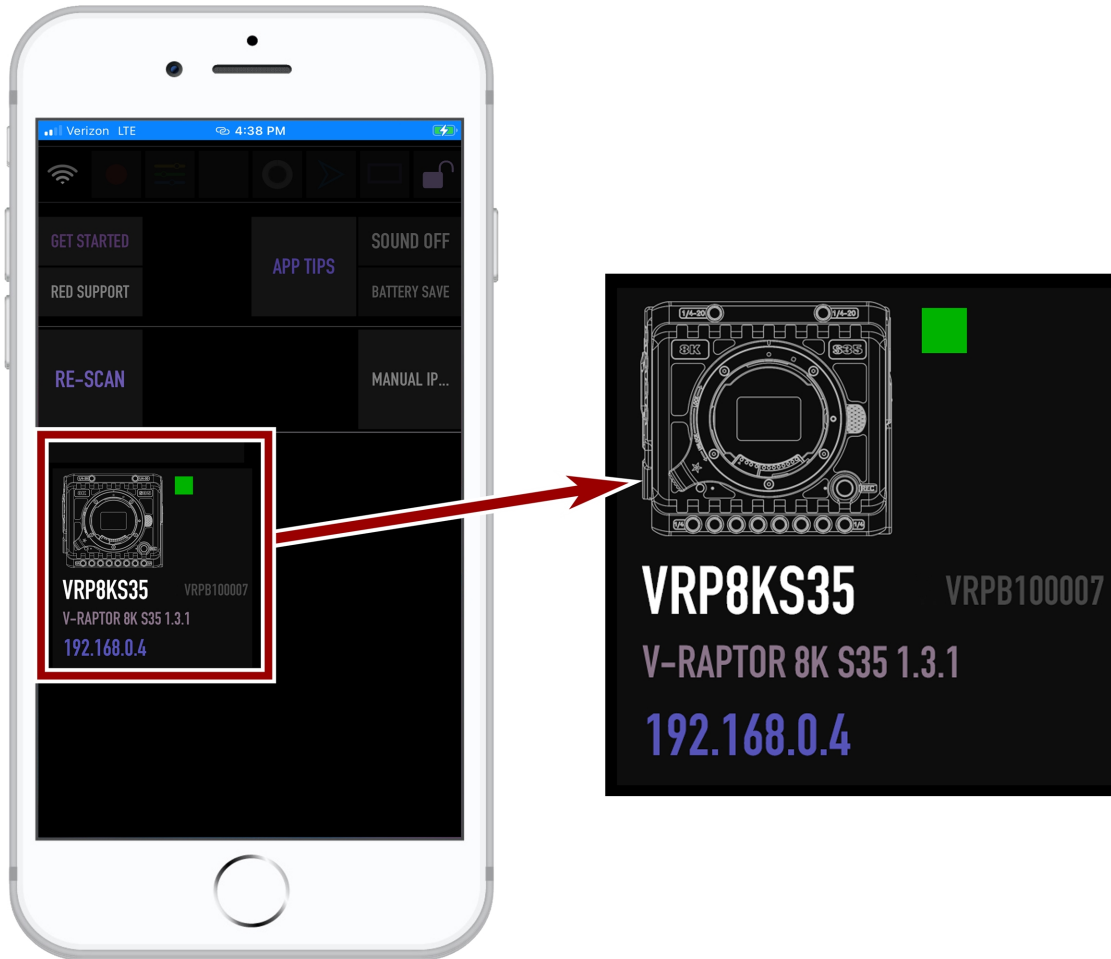

8. Tap the icon to open the RED Control app tools for the connected camera.

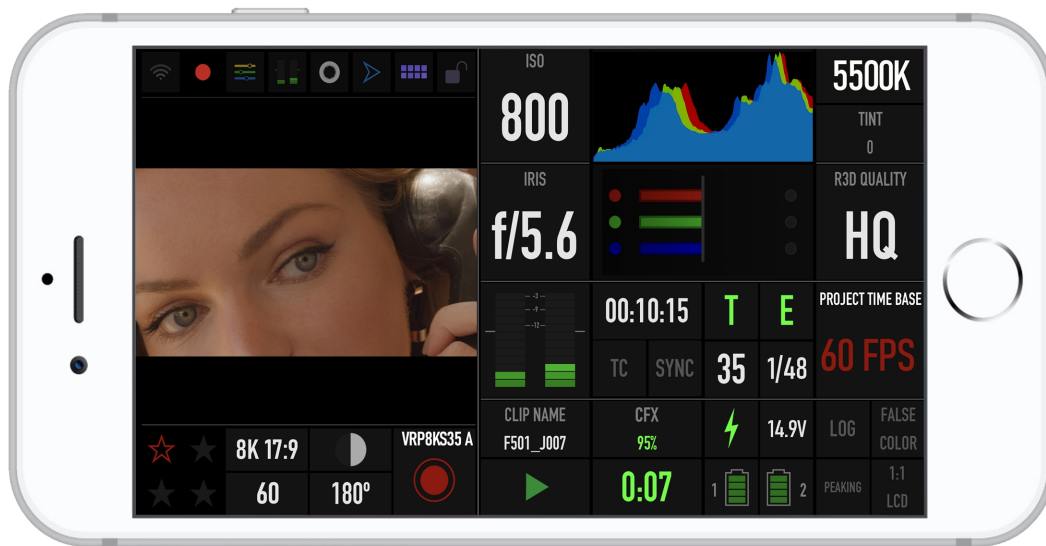

From here you can use the RED Control App to monitor and control the camera.

## USB-C ETHERNET CONFIGURATION

The RED V-RAPTOR 8K S35 offers a USB-C 3.0 protocol connection that provides communication support for Ethernet networks.

### CONNECTING TO AN ETHERNET NETWORK

You must use a USB-C to Ethernet adapter to connect the camera to an Ethernet network.

1. Connect the camera to the Ethernet network using the USB-C to Ethernet adapter.
2. From a Wi-Fi-enabled device, select the Wi-Fi connection to which the camera is connected.

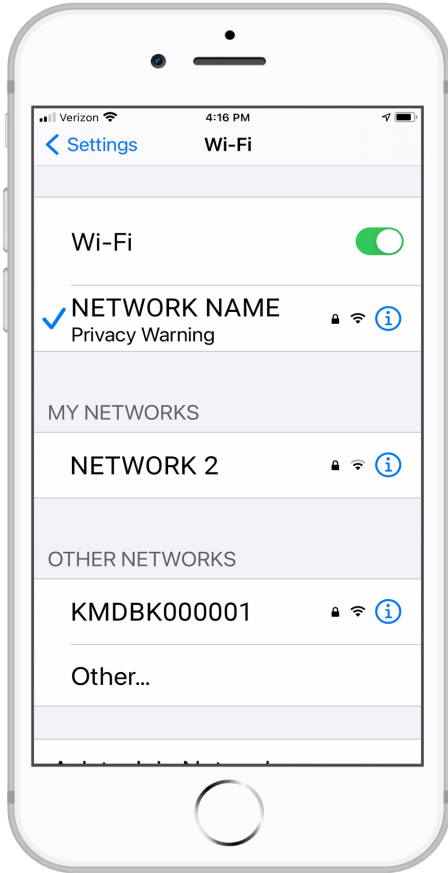

3. Open RED Control on the Wi-Fi-enabled device.

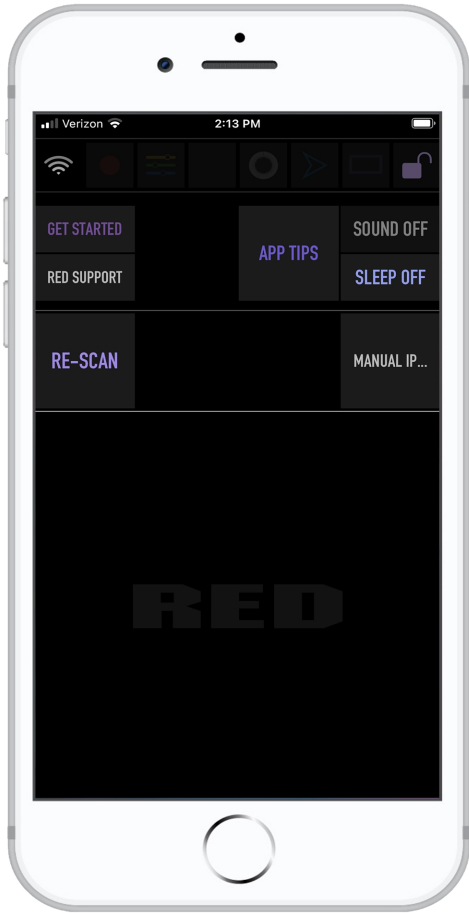

4. Tap RE-SCAN.  
The camera icon displays.

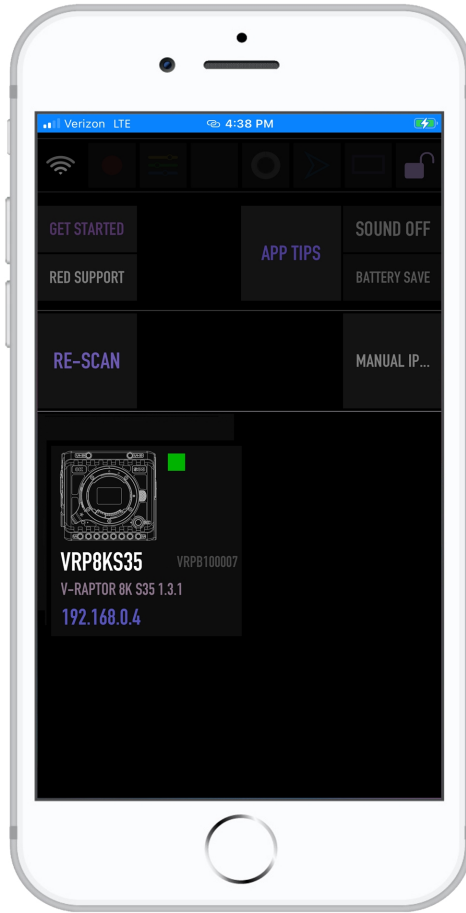

The camera icon displays the camera's Ethernet IP address:





5. Tap the camera icon to open the RED Control app tools for the networked camera.

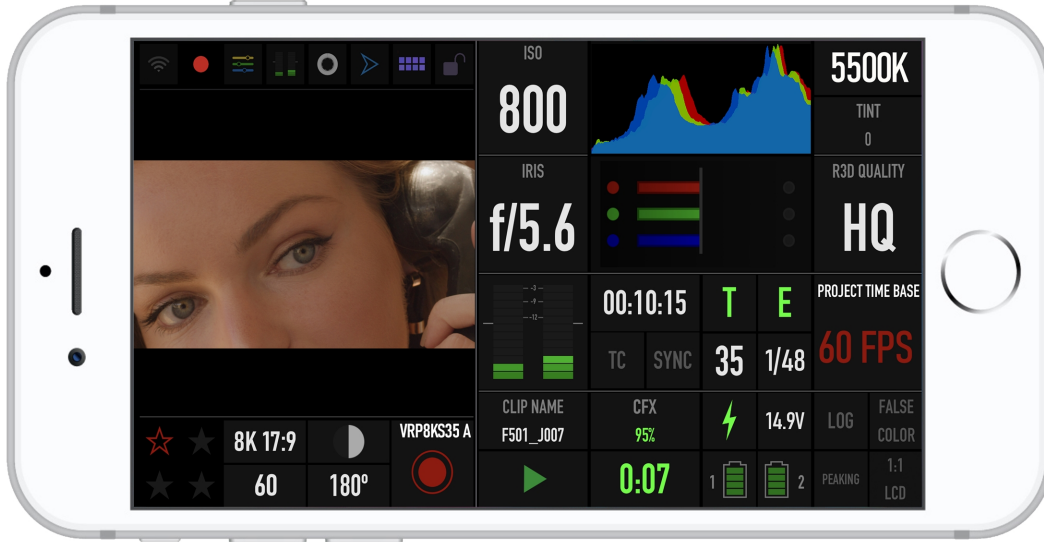

6. Open a browser from a computer connected to the Ethernet network.

7. In the browser address field, enter the camera IP address displayed on the RED Control camera icon or the camera Communication menus (Ad-Hoc, Infrastructure). The RED Control tools are displayed in the browser.

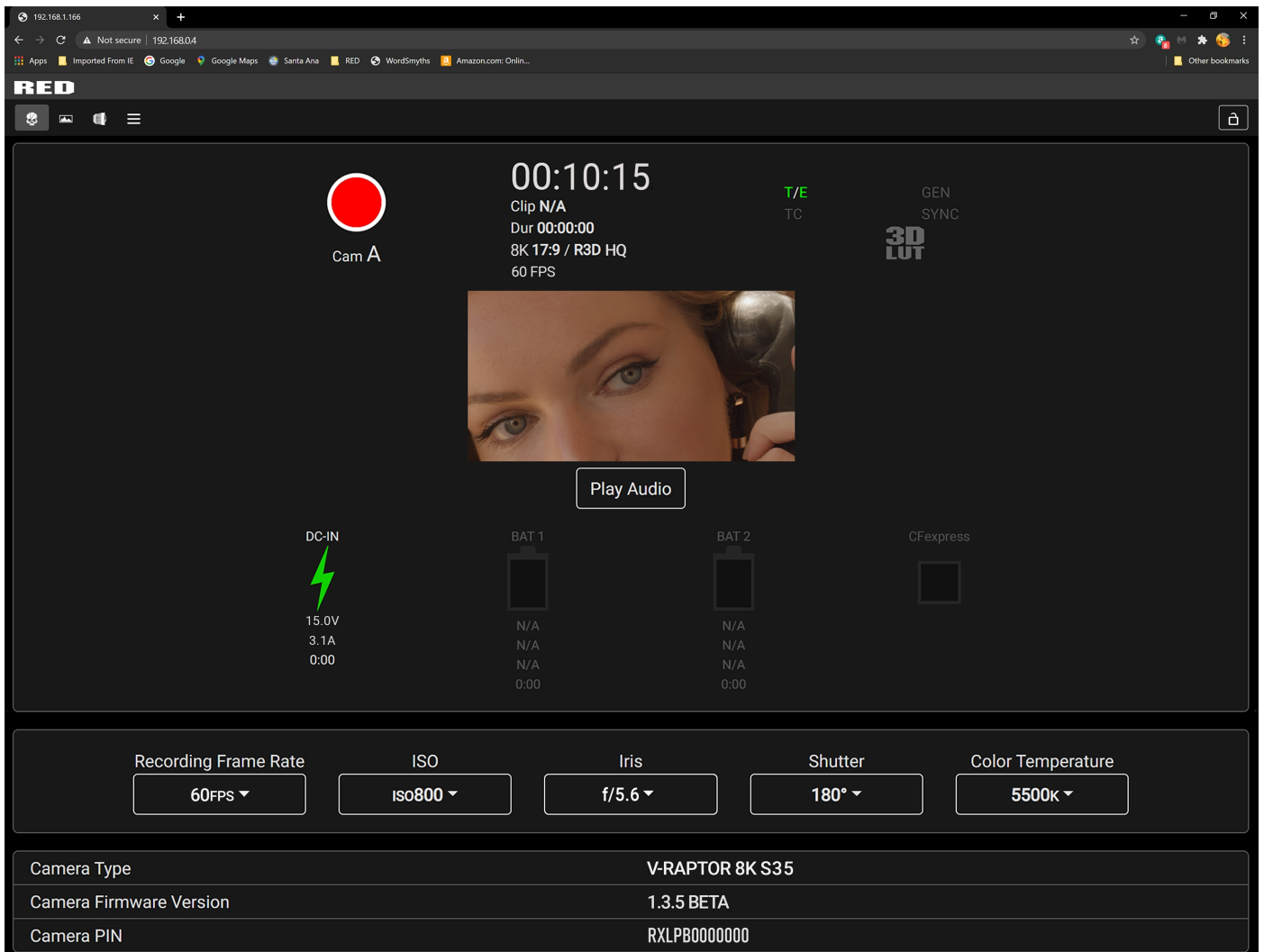

## POWER

The camera accepts power through a DC-IN port and through an attached battery. The camera cannot accept power through USB, D-Tap/P-Tap, or BNC ports.

## ATTACHING THE BATTERY

Insert a compatible V-Lock battery (refer to [REDVOLT Batteries](#)) in the battery slot. Slide the battery until it clicks.



The camera can charge the battery while it is attached to the camera, the camera is off, and the DC power adaptor is connected. The DC Power LED blinks amber until communication is established with the battery. The LED is solid amber when communication is established and the battery is charging. The LED is green when communication is not established (incompatible battery) and the battery is not charging.

**NOTE:** Incompatible batteries will not charge on the camera.

## REMOVING THE BATTERY

1. While holding the attached battery, press the **Eject Button**.
2. Slide the battery out.

## POWER COMPONENTS

You can power the V-RAPTOR 8K S35 camera with the [V-RAPTOR™ Power Adaptor](#), an External DC Power Source, or with the rear-mounted [REDVOLT Batteries](#).

For information about charging, storing, or maintaining the batteries, refer to the manufacturer's instructions.

## AUTO BOOT ON POWER

The camera supports the Auto Boot on Power feature. This means that if all power sources are removed, and the Power Switch is set to ON, then when a power source is attached, the camera turns on.

## POWER CONSUMPTION

The camera draws various levels of power depending on the configuration and operating conditions. When there are no auxiliary (AUX) power draws on the camera, the power consumption guidelines are:

- 65 Watts of power in the camera's basic recording configuration at room temperature, 8K, and 24 frames per second
- 75 Watts maximum when the camera is recording in a high ambient temperature, 8K, and 120 frames per second

## POWER PRIORITY

When multiple power sources are connected to the camera, power consumption is prioritized in this sequence:

1. Any power supply connected to the DC-IN port.
2. Attached battery.

**WARNING:** Always attach the power or battery before attaching the SDI BNC cable. Always remove the SDI BNC cable before removing the power or batteries. For more information about SDI BNC attachment, refer to [SDI 1 / 2](#).

## TURNING ON THE CAMERA

1. Attach a power source ([V-RAPTOR™ Power Adaptor](#) or [REDVOLT Batteries](#)) to the camera.
2. Slide the **Power Switch** up to the **ON** position.

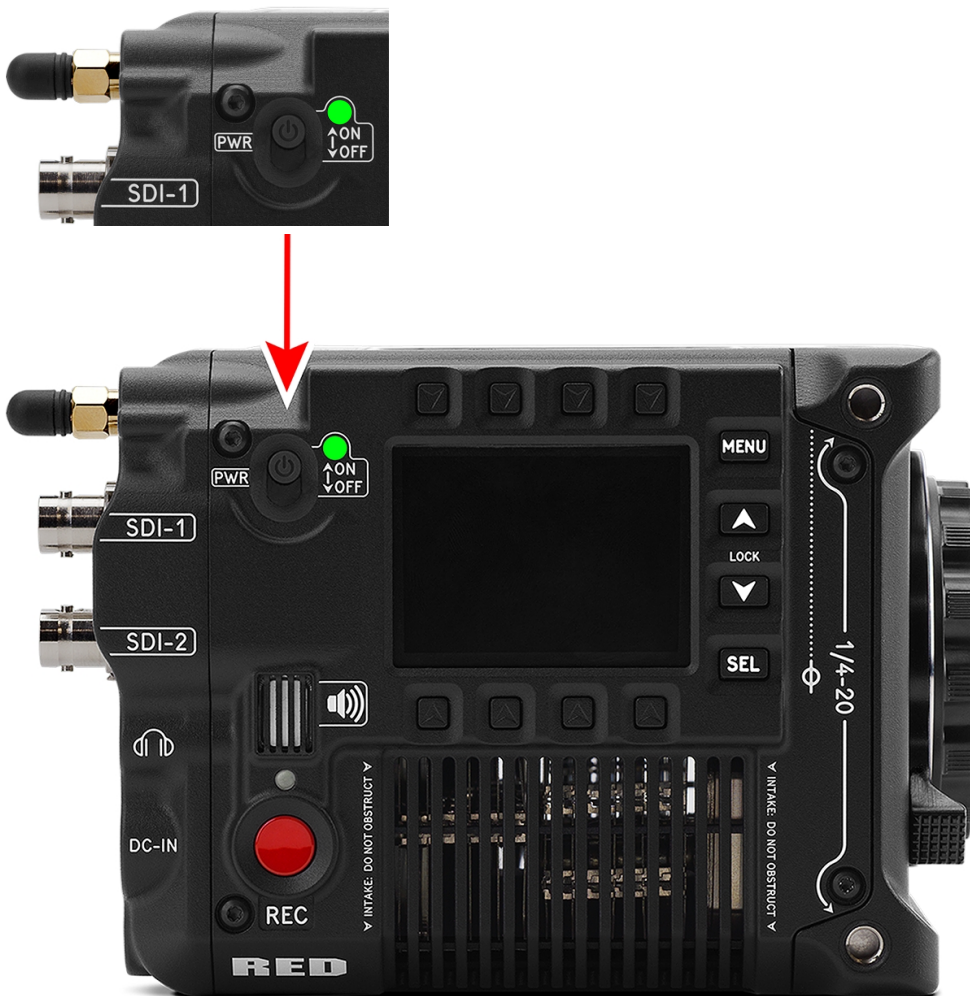

## TURNING OFF THE CAMERA

**NOTE:** Do not turn off the camera while the camera is recording, formatting media, updating firmware, or calibrating.

Slide the **Power Switch** down to the **OFF** position.



## MEDIA MANAGEMENT

This section explains how to use, record, format, and offload media for the camera.

**WARNING:** Do not attach a label to the CFexpress media card. The heat generated by the media can weaken the label's adhesive, causing the label to detach inside of the camera. Labels can also diminish heat dissipation and cause excessive wear to the internal components. Removing a label from a CFexpress media card can deform the card body.

The camera supports exFAT as the file system for the media card to accommodate larger files and data rates. exFAT is supported both on macOS and MS Windows.

## EJECTING MEDIA

**IMPORTANT:** To ensure data integrity, media must always be ejected prior to removal from the camera. This ensures that power is removed from the media and any open data files are closed. Failure to properly eject media may result in lost data or corrupted files.

To quickly eject the media, press and hold the button under MEDIA on the bottom of the LCD Home page (refer to [Home Page](#)).

To eject media from the camera by using the LCD menu, select **Menu > Media**.

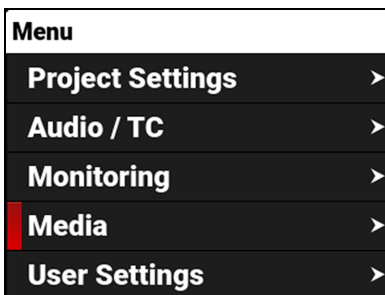

With Eject highlighted, press SEL to eject (unmount) the media:

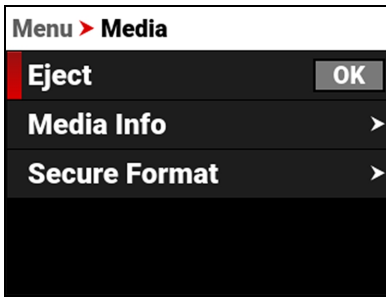

The Success message displays:

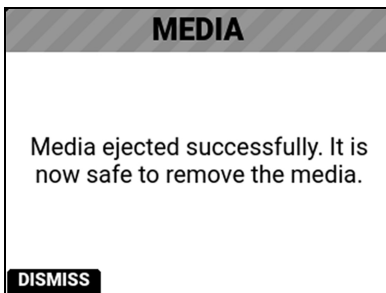

The media is now ejected and all media related items are grayed out in the menu.

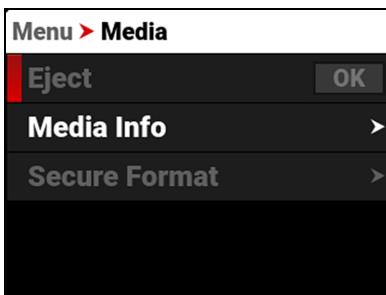

**WARNING:** The media can get extremely hot. Use caution when removing media.

Removing a CFexpress media card without ejecting it, increases the risk of file corruption. It is good practice to eject the media before removing or disconnecting. Ejecting the media provides the following benefits:

- Protects the integrity of your recorded data
- Mounts clips quickly to your workstation in post-production.

## INSERTING MEDIA

The camera contains a covered compartment on the left side where you insert the CFexpress media card.

**WARNING:** Do not attach a label to the CFexpress media card. The heat generated by the media can weaken the label's adhesive, causing the label to detach inside of the camera. Labels can also diminish heat dissipation and cause excessive wear to the internal components. Removing a label from a CFexpress media card can deform the card body.

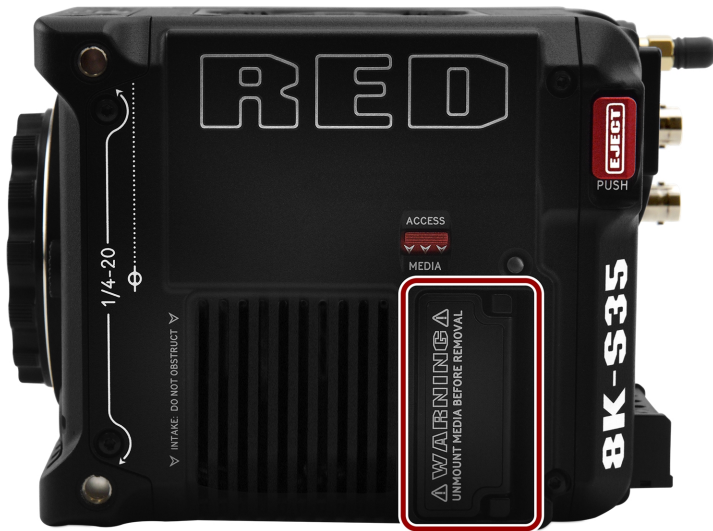

## INSERTING THE CFEXPRESS MEDIA CARD

1. Press the media door access latch down, and open the media door.



2. Insert the CFexpress media card in the slot with the top of the card facing toward the front of the camera. Insert the card until the lock clicks.

3. Close the media door and make sure that the door latch clicks.

4. If needed, format the CFexpress media card. Refer to [Secure Format](#) for more information.

## REMOVING THE CFEXPRESS MEDIA CARD

**NOTE:** Do not remove the CFexpress card without first ejecting using the Media Menu. Refer to [Media Management](#) for more information.

**WARNING:** The media can get extremely hot. Use caution when removing media.

1. If the camera is on, go to **Menu > Media** and select **Eject**. Optionally, press and hold the button under MEDIA on the bottom of the LCD Home page to quickly eject the media (refer to [Home Page](#)).
2. Press the media door access latch down and open the media door.



3. Press the CFexpress media card until the lock release clicks. The card will spring out slightly.



4. Let the CFexpress media card cool before gently pulling the card out of the slot.

**WARNING:** The media can get extremely hot. Use caution when removing media.

5. Close the media door and make sure that the door latch clicks.

## SECURE FORMAT

A secure format is a low-level format that rebuilds the CFexpress card file system. A secure format erases all data on the card.

Perform a secure format when the camera is reporting media-related errors.

### PERFORMING A SECURE FORMAT

**CAUTION:** Ensure all data is backed up before formatting a card. **Data erased during formatting cannot be recovered.**

**WARNING:** The media can get extremely hot. Use caution when removing media.

To perform a secure format, follow the instructions below:

1. Go to **Menu > Media > Secure Format:**

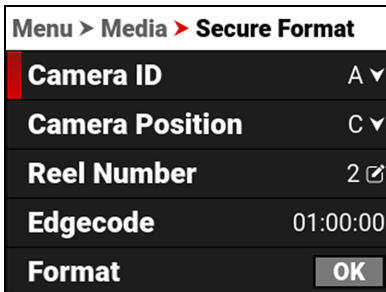

2. From the Secure Format menu, select the desired **Camera ID**, **Camera Position**, **Reel Number** and **Edgecode**. Navigate down to the **Format** button and press SEL to start the Secure Format process:

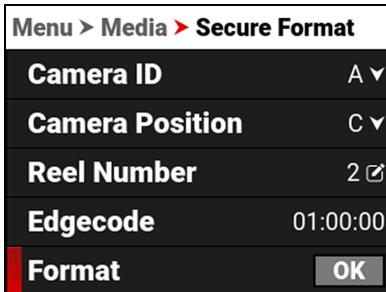

The confirmation message displays:





3. Press the button below YES to begin formatting.

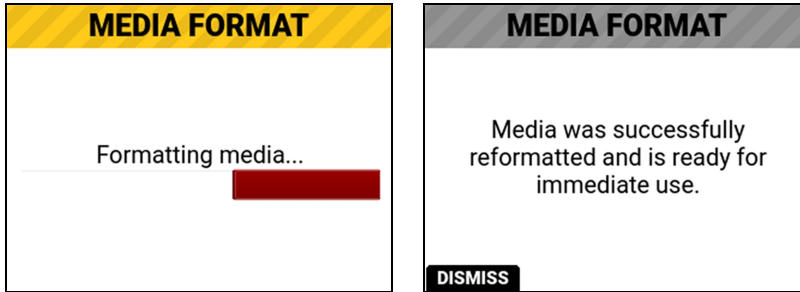

## FORMATTING MEDIA ON A COMPUTER

RED recommends that you only use a computer to format your CFexpress media card when you cannot mount the media to the camera. Refer to the [Troubleshooting](#) section for more information.

## MEDIA INFORMATION

Use the [Media Info](#) menu to display the CFexpress media card information.

Media information includes the following:

| ITEM                 | DETAILS   |
|----------------------|---|
| Status               | CFexpress media card status                               |
| Model Number         | CFexpress media card model number                         |
| Serial Number        | CFexpress media card serial number                        |
| Firmware Version     | CFexpress media card firmware version                     |
| Percentage Remaining | CFexpress media card's remaining storage*                 |
| Time Remaining       | The recording time remaining on the CFexpress media card* |

\* with the current project settings

## FILE SYSTEM

The V-RAPTOR 8K S35 camera formats the CFexpress media card using exFAT. Both Mac® and Windows®-based computers support CFexpress media cards with this format. Refer to the documentation for your operating system to determine whether there are any limitations to its file format support.

## CLIP FOLDER NAMING CONVENTION

When you record a clip, the camera creates a unique name for the clip folder that uses the format described in the table below:

| ITEM           | DETAILS  | EXAMPLE |
|----------------|--|---------|
| Camera ID      | The letter assigned to the camera (refer to <b>Camera ID</b> )                   | A       |
| Reel ID        | The reel number assigned to the media (refer to <b>Reel Number</b> )             | 004     |
| Clip Number    | The camera position letter followed by three digits starting with 001            | C001    |
| Month          | Month that the clip is recorded (refer to <b>Date / Time</b> )                   | 12      |
| Day            | Day that the clip is recorded (refer to <b>Date / Time</b> )                     | 04      |
| Two Characters | Two random alphanumeric characters generated by the camera to prevent duplicates | 6M      |
| .RDC           | Clip folder extension  | .RDC    |

For example, a sequence of clip folders within a media folder on camera "A" position "C" may look like this:

- A001\_C001\_12046M.RDC
- A001\_C002\_1204CE.RDC
- A001\_C003\_1204R5.RDC

## CLIP METADATA

The following metadata is recorded for each frame of each clip:

- Audio Data
- Broadcast Wave Format (BWF)
- Clip
- Configuration, Camera Name, Network, Model, Model ID, Serial Number
- Copyright
- Date and GMT
- Filename
- Firmware Version
- Frame Guides
- Jamsync Setting
- Lens and Shutter Speed/Angle Parameters
- Lens Name, Brand, ID, Near Focus, Far Focus
- Location
- LTC User Bits (3 32-bit word reg-dump from ISP)
- Media Serial Number
- Production Name
- REDCODE®
- Reel
- Scene
- Stereo Setup
- Take
- Timecode
- Unit

## MEDIA BEST PRACTICES

This section describes best practices to ensure that your CFexpress cards continue to provide reliable storage and fast data rates. Following these best practices may prevent your CFexpress card from becoming fragmented, which can lead to data integrity errors.

- The only files that should be saved from your computer to your CFexpress card are Preset files, Firmware Upgrade files, and LUTs. DO NOT save other files, folders, or applications to your media.
- DO NOT back up your hard drive to the CFexpress card. If using a Mac, the system may ask if you want to back up your files to the CFexpress card using Time Machine; DO NOT use the CFexpress card as a backup disk.
- DO NOT delete clips off of your CFexpress card using a computer. Delete clips only by formatting your CFexpress card in-camera. For more information about formatting your CFexpress card, refer to [Secure Format](#).
- DO NOT format your CFexpress card using a computer, unless the CFexpress card cannot mount to the camera. For more information, refer to [Secure Format](#).
- When ejecting the CFexpress card from a computer, ensure that the icon has completely disappeared from the Finder window (Mac) or from Windows Explorer (Windows) before removing the CFexpress card. Sometimes, the pop-up saying that the CFexpress card has ejected displays too early.
- When the reader has a write-protect switch, such as the RED® CFexpress Type B Card Reader, it is recommended that you set the card reader to write-protect when uploading clips to prevent connected devices from adding any unwanted data to your CFexpress Type B card.

## INDEXING ON A MAC

**NOTE:** You can use the RED CFexpress Type B card reader with Write-Protect to prevent the Mac OS from indexing your CFexpress Type B card (refer to RED® CFexpress Type B Reader).

Most newer versions of the Mac OS automatically index all external drives when you connect them. This includes when you connect CFexpress cards.

Indexing makes the connection process take longer. While the CFexpress card connects to the Mac, DO NOT remove the card. Indexing writes hidden files to the CFexpress card. When you insert an indexed CFexpress card in the camera, it can take the camera a while to recognize the hidden files and connect to the CFexpress card. While waiting for the CFexpress card to connect, DO NOT remove the CFexpress card or turn off the camera. After the camera successfully connects to the CFexpress card, perform a secure format to remove the hidden files. For more information, refer to [Secure Format](#).

## RED MONITOR INTERFACE CABLE

The DSMC3™ RED® Touch 7.0" LCD monitor includes a custom RED Monitor Interface (RMI) cable that provides communication between the RMI and the monitor.

Where this cable attaches to the RMI and the monitor, there are special locking features that keep the cable from accidentally detaching.

**NOTE:** The RMI cable is attached to the monitor at an angle, as shown in the image.

To unlock the cable locks, rotate the RMI cable lock and slide the monitor cable lock, as shown in the image:



**NOTE:** The USB-C-style DSMC3™ RMI cable is a custom-Pinned cable, which is not compatible with standard USB-C cable ports (including the rear camera USB-C port). The EXP ports on the RMI are for future use and are not currently supported.

### Optional RED Monitor Interface (RMI) cables:

- 10" DSMC3™ RMI Cable
- 18" DSMC3™ RMI Cable
- 39" DSMC3™ RMI Cable

## MONITORING

The camera provides several methods for monitoring the image. These monitoring methods include:

- DSMC3™ RED® Touch 7.0" LCD
- SDI output to a monitor
- RED Control over Wi-Fi to iOS or Android devices
- RED Control over USB-C to iOS or Android devices
- USB-C to Ethernet adapter to a computer
- Live Stream

## DSMC3™ RED® TOUCH 7.0" LCD

The optional DSMC3™ RED Touch 7.0" LCD provides a 1920 x 1200 resolution live image from the camera sensor. By using the Monitoring menu, you can use display guides, exposure tools, focus tools, and a magnified image on this monitor (refer to [Top LCD](#)).

## SDI OUTPUT TO A MONITOR

The SDI ports provide a 12G SDI signal to allow viewing of the camera image on a 4K SDI monitor. The output signal bit depth is 10-bit 4:2:2.

Use the SDI menus to select the settings for SDI output, Tools, and Guides (refer to [SDI 1 / 2](#)).

**WARNING:** Under certain circumstances, it is possible for an SDI connector to incur damage when connected to an accessory and powered without using shielded cables. RED recommends only using high quality, shielded BNC cables that are rated for 12G-SDI signals and only using shielded power cables for powering SDI accessories.

Make sure power is connected to the SDI accessory at all times before you connect the BNC to the camera.

Ungrounded power from SDI accessories can damage the camera's SDI port. To avoid this possible damage, attach the power source to the accessory before attaching it to the BNC cable. When using RED Approved Third Party battery plates, unplug the BNC cable prior to hot swapping.

When possible, avoid using P-Tap (also known as D-Tap) cables to power accessories. To avoid damage when using P-Tap/D-Tap, it's imperative that the connect/disconnect sequence (below) is followed precisely.

## BNC ATTACHMENT INSTRUCTIONS

When attaching SDI accessories:

1. Connect a power source to the SDI accessory; power on the SDI accessory.
2. Ensure a power source is connected to the camera. This ensures both are grounded prior to connecting the BNC. The camera's power state does not have an impact on SDI attachment sequence.
3. Connect the BNC cable to the accessory, then to the camera.

When detaching an accessory mounted to an SDI output, ensure that you remove the BNC connection to the camera before removing power to the SDI device:

1. Shutdown the SDI accessory.
2. Disconnect the BNC cable from the camera.
3. Disconnect the power source from the SDI accessory.

When you need to swap out a battery on an accessory mounted to the camera's SDI port, you must:

1. Shutdown the SDI accessory.
2. Disconnect the BNC cable from the camera.
3. Replace the battery on the SDI accessory.
4. Connect the BNC cable to the camera.
5. Power on the SDI accessory.

For more information about SDI safety, refer to [Preventing Damage to SDI Outputs](#).



Figure: SDI monitor with SDI Standard Overlay Mode enabled

## SDI port specifications:

- Integrated 12G-SDI with 6G-SDI, 3G-SDI, and 1.5G-SDI modes
- 12G-SDI: Up to 4096 × 2160 10-bit 4:2:2 for 60p
- 6G-SDI: Up to 4096 × 2160 10-bit 4:2:2 for 30p
- 3G-SDI: Up to 2048 × 1080 10-bit 4:2:2 for 60p
- 1.5G-SDI: Up to 720p and 1080i 10-bit 4:2:2 for 30p and 24p
- SMPTE Timecode
- HANC metadata
- Up to four (4) channels of 24-bit 48 kHz audio (refer to [Audio Source](#))

You can enable or disable the image magnification, the focus and exposure tools, and the guides displayed on images sent to the SDI monitor by using the SDI menus (refer to [SDI 1 / 2](#)).

From the side LCD, navigate to the SDI tools (refer to [SDI Page](#)).

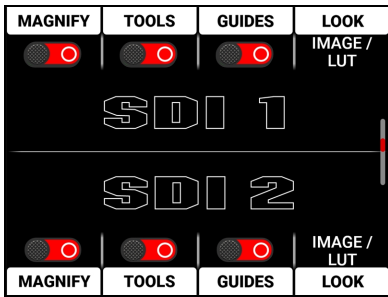

You can enable or disable the following monitoring tools on SDI, (refer to [SDI 1 / 2](#)):

- Magnify
- SDI tools
- SDI guides

You can also select the Image / LUT look defined in the Image / LUT menu, or you can select the RWG (REDWideGamutRGB) / Log3G10 Image Processing Pipeline (IPP2) look.

## RED CONTROL

RED Control allows you to use Wi-Fi to connect to the camera and send monitor images to iOS and Android devices.

**NOTE:** You must enable live streaming under **MENU > MONITORING > LIVE STREAM** to enable the image feed.

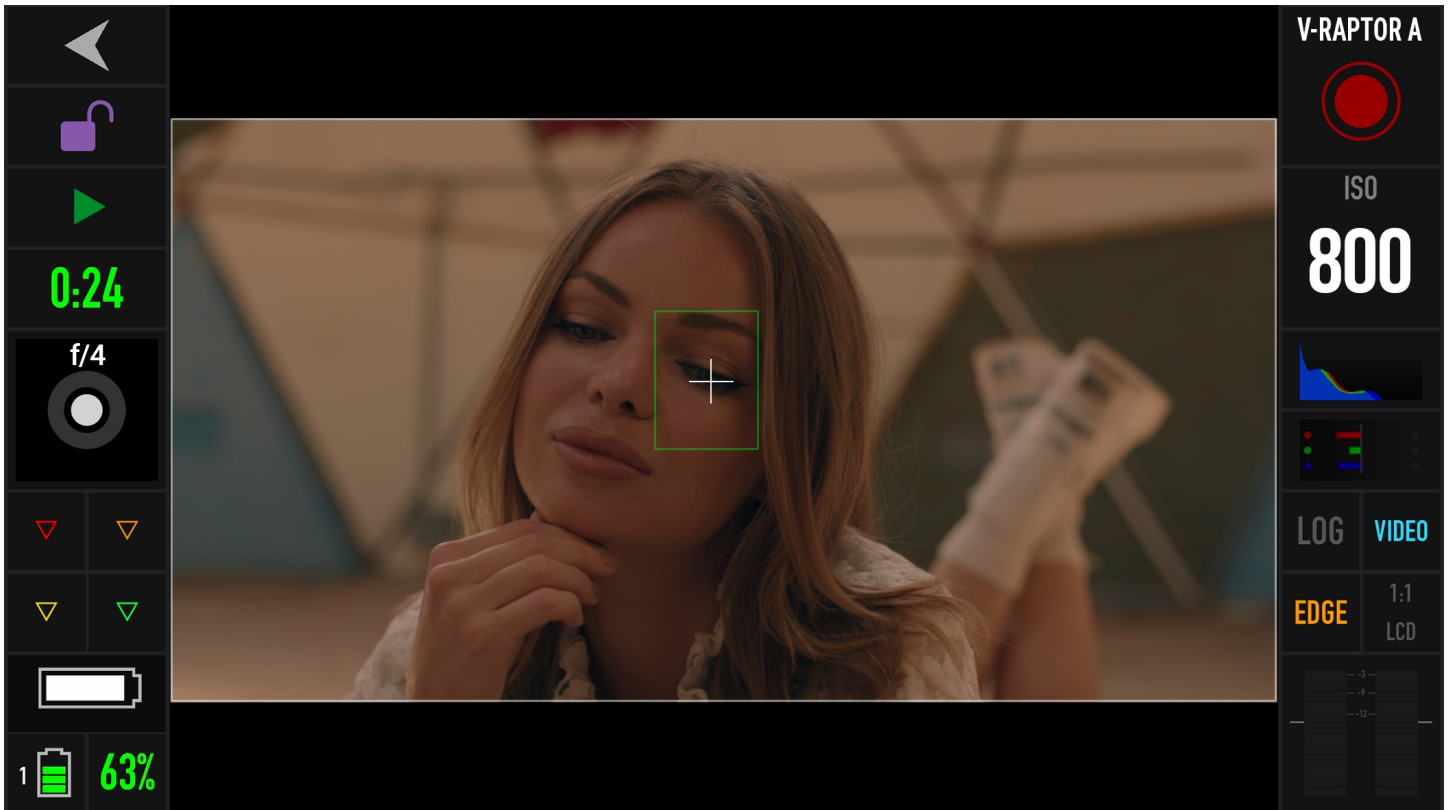

Figure: RED Control phone monitor over Wi-Fi

## USB-C

Use a USB-C cable to connect to the camera and send monitor images in real-time to cellular devices using the RED Control app.

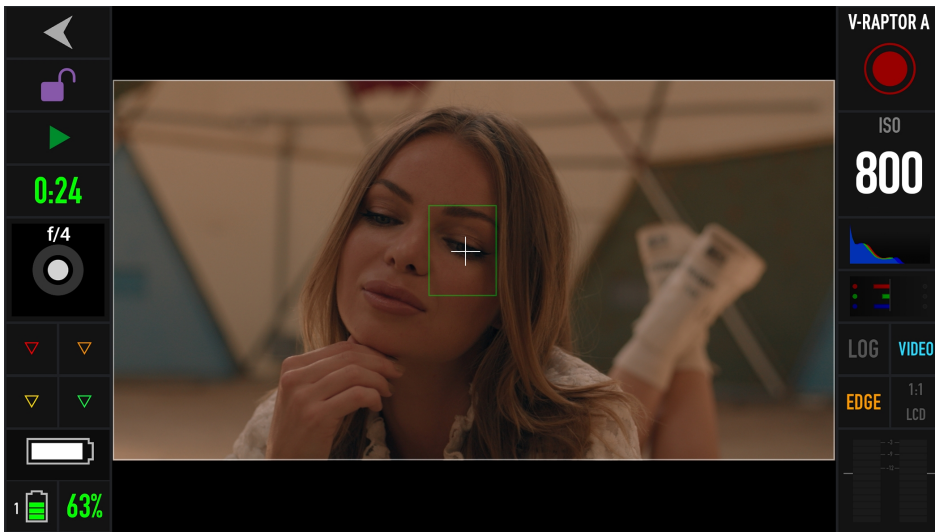

Figure: USB-C connected to an Android cellular phone with the RED Control app

With the use of an Ethernet to USB-C adapter, you can also connect Ethernet devices.

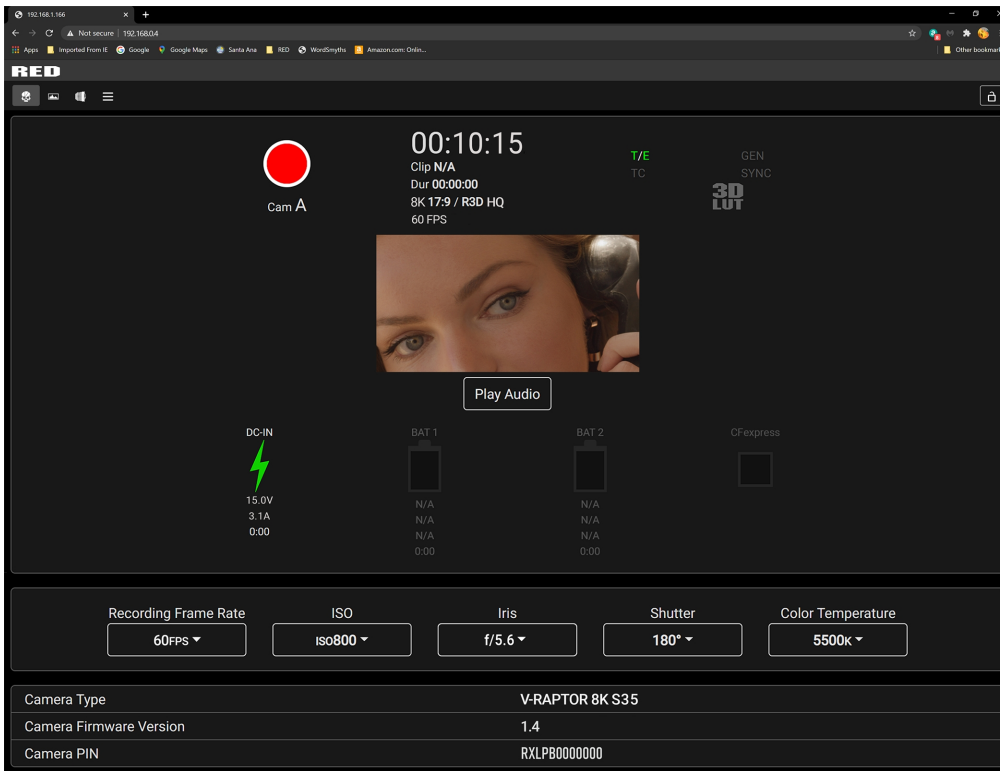

Figure: USB-C connected to an Ethernet web browser

You can add :9090 to the end of the URL in your browser to bring up an image-only feed for remote viewing.

**NOTE:** You must enable live streaming under **MENU > MONITORING > LIVE STREAM** to enable the image feed.



## EXPOSURE

The camera offers multiple tools to determine the current image exposure levels, and it provides the tools to adjust the exposure to the desired levels.

When using the R3D file format, you can correct color temperature and ISO settings at any time. The aperture and exposure time however, are two of the parameters that you cannot corrected later in R3D files.

**NOTE:** The ProRes file format burns in ISO and White Balance, and does not allow you to adjust these settings post-recording like you can with the R3D format.

While the correct exposure is always an artistic decision, there are best practices for capturing the most dynamic range while also allowing post-production to preserve the intended image information.

The goal is to reduce clipping in the bright and dark parts of the image as much as possible. Otherwise, the sensor information is lost in the overexposed and underexposed areas.

The primary tool for determining the exposure levels is the histogram. It shows the exact luminance levels of the red, green, and blue pixels after you apply the ISO and White Balance settings. Monitors have their own color gamuts and brightness levels which make the monitor less than optimal for determining the camera's exposure levels.

This camera includes a histogram, and a simple RGB raw pixel exposure meter, which allows you to determine proper exposure regardless of the set ISO or camera look (for more information refer to [Histogram Page](#)).

The histogram provides information about how the brightness is distributed in the image. This allows you to see how close a scene is to clipping in the light and dark areas, which makes it easy to choose aperture, exposure, and ND filter solutions accordingly.

## FALSE COLOR EXPOSURE TOOLS

While the histogram provides information about the brightness distribution and clipping of the image, it does not show you the areas in the image that are near, or that have reached, clipping. For this, the camera provides image overlays that provide false colors to indicate precise exposure levels.

## FALSE COLOR EXPOSURE MODE

The False Color Exposure mode overlay provides information where the image is close to clipping or already clipping in the highlights (red) and low-lights (green) (refer to [False Color Exposure Mode](#)).

Example of monitored image in Exposure Mode:

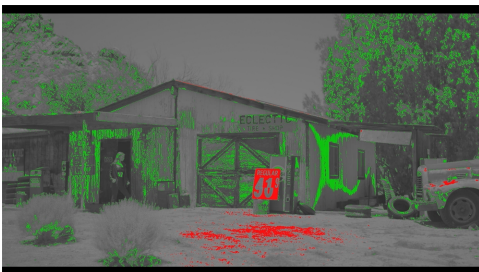

## FALSE COLOR VIDEO MODE

The False Color Video mode provides more gradual information about the brightness in different parts of the image. This is helpful when you want to expose skin color at the right level, while ignoring the fact that backgrounds might be overexposed or underexposed (refer to [False Color Video Mode](#)).

Example of monitored image in Video Mode:



## FOCUS

Focus, like [Exposure](#) and [Recording Frame Rate](#) is a property that cannot be fixed easily in post-production. To make sure the camera is focused correctly when you begin recording, it is important to employ focus tools that do not rely on the visibility on the monitor.

The camera interface includes the focus tools you can use to reach the desired image focus (refer to [Peaking](#)).

## FOCUS PEAKING MODE

The Focus Peaking mode applies a sharpening filter to the image that emphasizes edges of the subject in focus.

Example of monitored image in Focus Peaking mode:



## EDGE PEAKING MODE

The Edge Peaking mode hides the image and only show the edges. This provides the best visual representation of the subject that is currently in focus.

Example of monitored image in Edge Peaking mode:



## PEAKING PEAKING MODE

The Peaking Peaking mode emphasizes the edges, and it also highlights them by using a selectable color.

Example of monitored image in Peaking Peaking mode:



## TIMECODE

Timecode provides a mechanism to reference frame timing from the camera's recorded clips to other devices like cameras and audio recorders. Some devices can also gather other data like lens metadata or camera orientation that is referenced by Timecode to merge the data back together in post-processing.

V-RAPTOR 8K S35 provides two separate Timecode concepts: Time of Day (TOD) and Edgecode. Both TOD and Edgecode are stored in the R3D file. The user can select which Timecode displays on the LCD by setting the preference in **Timecode Display Mode**.

## TIME OF DAY

TOD Timecode reflects the time and date the camera recorded each frame. V-RAPTOR 8K S35 synchronizes the TOD Timecode to an external Timecode generator (when one is connected to the **Extension Port**) or synchronizes to the internal real-time clock of the camera.

## SETTING UP TOD TIMECODE

To set up TOD Timecode on the camera, perform the following:

1. Open the Audio / Timecode menu: **Menu > Audio / TC:**

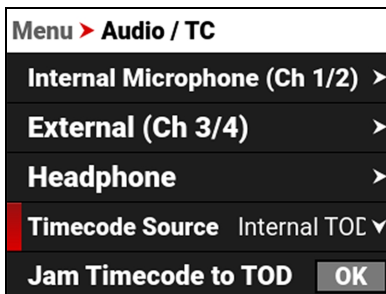

2. Select Timecode Source. The Timecode Source menu opens:

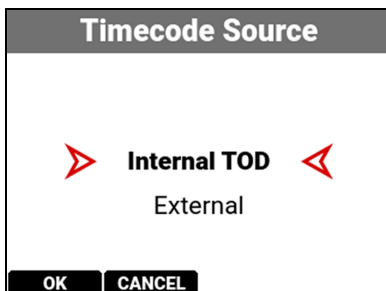

3. Select Internal TOD to use the camera's internal real time clock, or select External to use an external Timecode generator connected to the **Extension Port**. Press the button under OK to confirm the selection.
4. When you select Internal TOD, you can navigate to **JAM Timecode to TOD** and press SEL to synchronize the Timecode to the camera's internal clock.

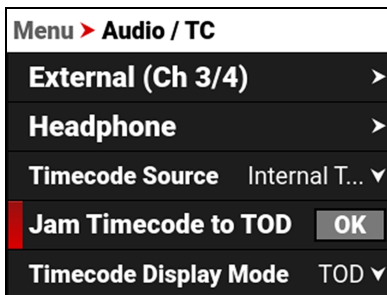

The camera displays the Timecode on the **LCD** Home page:

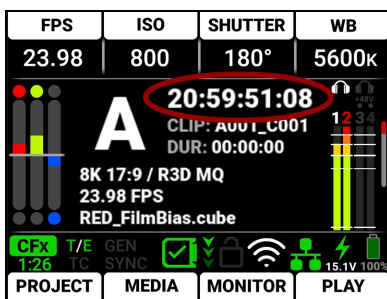

**NOTE:** The timecode is reset when the camera is turned off.

## EDGECODE

Edgecode only advances while the camera is recording frames. Each frame is sequential. When the media is replaced, the new media starts the timer over. You can set the Edgecode timer manually by using Secure Format (refer to **Secure Format** for more information).

### SETTING UP EDGECODE TIMECODE

To set up Edgecode Timecode on the camera, perform the following:

1. Open the Audio / Timecode menu: **Menu > Audio / TC:**

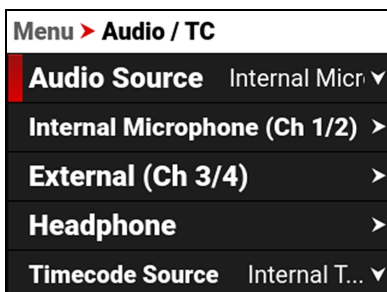

2. Navigate down to Timecode Display Mode:

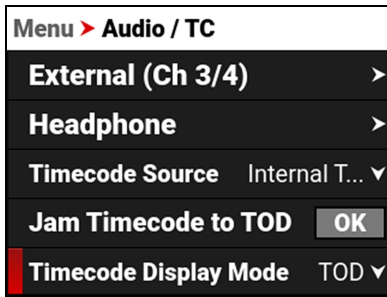

3. Press SEL to select Timecode Display Mode. The Timecode Display Mode menu opens:

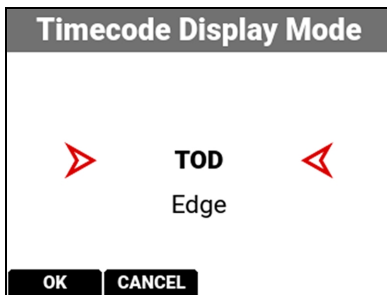

4. Select Edge and press the button under OK to use Edgecode. The camera displays the Edgecode on the LCD Home page:

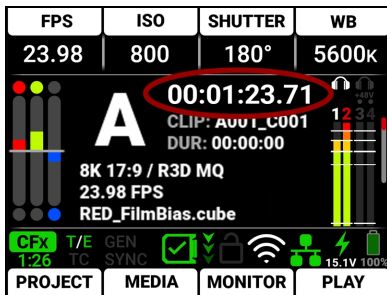

**NOTE:** Each new media card will default to an edgecode track starting at 01:00:00. You can change the edgecode to begin at any desired time by using the Media Format menu (refer to [Edgecode](#)).

## ZEBRA MODES

Use Zebra modes to enable and adjust the upper and lower values for two (2) independent zebra indicators. Use Zebra 1 for highlight exposure, and use Zebra 2 for mid-tones or shadows. Zebras are disabled by default.

For more information, refer to the [Exposure with RED Cameras: False Color and Zebra Tools](http://www.red.com/red-101/exposure-false-color-zebra-tools) article, available at [www.red.com/red-101/exposure-false-color-zebra-tools](http://www.red.com/red-101/exposure-false-color-zebra-tools).

### ENABLING THE ZEBRA 1 INDICATOR

1. Go to **Menu > Monitoring > Tools** and select **Zebra 1**.
2. Set a Low IRE of 98.
3. Set a High IRE of 100.

Areas of the image exposed within the IRE range are indicated by red diagonal lines at  $-45^\circ$ .

The default settings are Low IRE = 98 and High IRE = 100.

### ENABLING THE ZEBRA 2 INDICATOR

1. Go to **Menu > Monitoring > Tools** and select **Zebra 2**.
2. Set a Low IRE of 41.
3. Set a High IRE of 48.

Areas of the image exposed within the IRE range are indicated by green diagonal lines at  $45^\circ$ .

The default settings are Low IRE = 41 and High IRE = 48.

## ZEBRA OVERVIEW

Zebra is a specialty mode that is capable of showing up to two customized overlays with arbitrary IRE ranges. Unlike the other two modes, Zebra indicators appear as diagonal stripes, they are fully configurable, and they have the advantage of preserving a full-color base image.

With traditional video cameras, many used a single zebra to indicate highlight detail. It would often be set at 70% (70 IRE), in part because this is where a white piece of paper would begin to have minimal texture when rendered using a typical contrast curve. Skin tones or skies would be exposed to appear just darker or brighter than these lines. If enabled, a second zebra would typically indicate either mid-tones or shadows. For deep shadows, you can set the second indicator to below 10% intensity or 10 IRE, and set the first indicator to highlights above 85 IRE.

However, as with other IRE-based modes, Zebra mode is only applicable for the current ISO settings (such as with SDI output), not for the raw image data. If anything is changed in post-production, the indicators won't be representative of the final output tones. In those situations, Zebra mode is more of a preview and output brightness tool than an exposure tool.

## PRE-RECORDING CONTENT

This section explains how to use the Pre-Record feature.

To start pre-recording, press the **Record** button.

The LCD changes from the Ready appearance to the Pre-Record appearance:

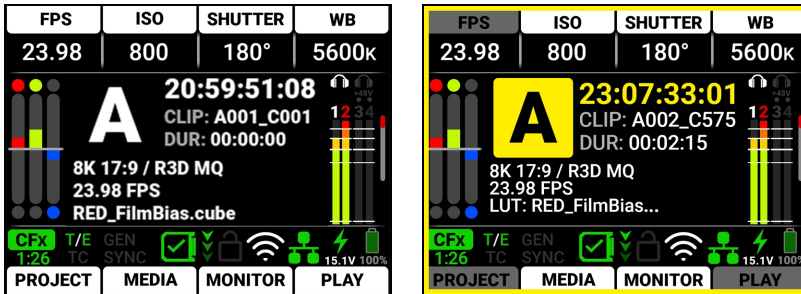

Press the **Record** button again to start recording.

When you start recording, the appearance of the LCD changes from the Pre-Record appearance to the Record appearance:

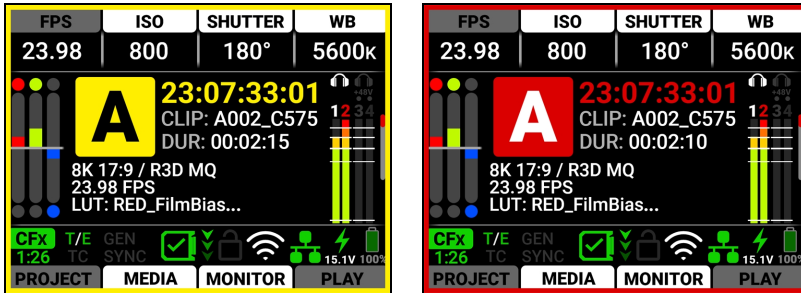

The camera adds the Pre-Record clip to the beginning of your recording. This clip is recorded to an internal buffer to protect media longevity. The available lengths of Pre-Record clips vary depending on the Format, Quality, Resolution, and Frame Rate you use.

For information about enabling and configuring Pre-Record, refer to [Pre-Record](#).

## CALIBRATING THE SENSOR

Sensor calibration is a process during which the camera optimizes image quality by ensuring that pixel sensitivity remains consistent throughout the sensor.

## WHEN TO CALIBRATE THE SENSOR

Calibration is recommended:

- When shooting in an environment where the temperature is significantly different (+/- 30° F...) from the current calibration. The T in the T/E Status Bar indicator will turn yellow (refer to [Status Bar](#) for more information)
- After an extreme change in exposure time (+/- 1/2 sec). The E in the T/E Status Bar indicator will turn yellow (refer to [Status Bar](#) for more information)
- After each firmware upgrade
- After changing the sensor scan direction
- When you have any image quality concerns

## UPGRADING THE FIRMWARE

You can receive the best performance from your camera by installing the latest firmware. Make a habit of frequently visiting RED Downloads at [www.red.com/downloads](http://www.red.com/downloads) to check for new versions of camera firmware, updated operation guides, and post-production software.

## VERIFYING THE FIRMWARE VERSION

To view the firmware version that is currently installed on your camera, open **Menu > System Settings > System Status > Camera Info**:

| ... > System Status > Camera Info |               |
|-----------------------------------|---------------|
| <b>Camera Type</b>                | V-RAPTOR 8... |
| <b>Camera PIN</b>                 | VRPB0000000   |
| <b>Version</b>                    | 1.4           |
| <b>Runtime</b>                    | 13.2 Hours    |

Version displays the currently installed camera firmware. A higher number reflects a newer release.

## UPGRADING THE FIRMWARE

Install the most recent firmware. Unless otherwise specified in the release notes, you do not need to upgrade to any firmware in between your current version and the most recent version available online.

**NOTE:** You must calibrate the sensor after upgrading the camera. For more information, refer to [Calibrating the Sensor](#).

1. Download the most recent firmware for your camera from RED Downloads at [www.red.com/downloads](http://www.red.com/downloads).
2. Unzip the firmware zip file.
3. In the unzipped folder, navigate to the **upgrade** folder.
4. Copy the **upgrade** folder and its contents to the root level of the CFexpress media card directory.
5. Unmount the CFexpress media card from your computer and remove the media card from the media reader.
6. Insert the CFexpress media card in the camera.



7. From the camera UI, navigate to **Menu > Maintenance**.

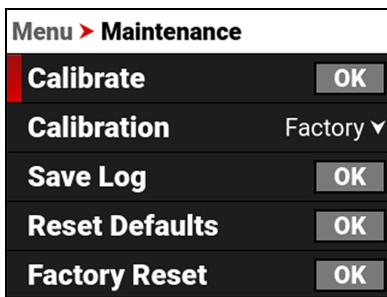

8. From the Maintenance menu, navigate down to Upgrade and press SEL.

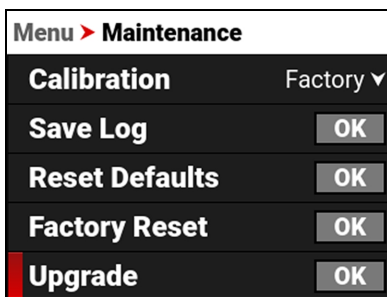

The Firmware Upgrade confirmation screen displays:

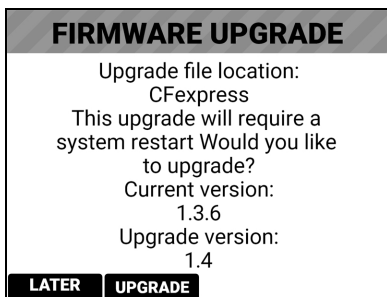

9. Press the button under **UPGRADE** to confirm. The Firmware Upgrade progress screen displays:

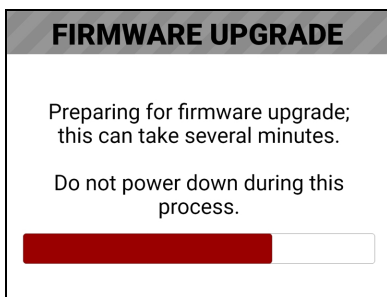

During the upgrade, the fans run at high speed and the following occurs:

- The camera displays the **SHUTTING DOWN** screen and reboots
- The camera restarts and displays the **UPGRADING** screen
- The camera displays the **INITIALIZING** screen
- The camera displays the **FIRMWARE UPGRADE** progress screen:

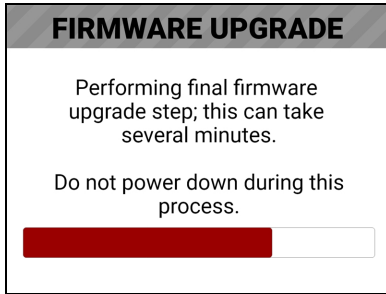

The Firmware Upgrade success message screen displays with a **RESTART** button:

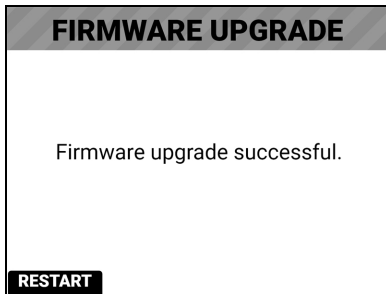

10. Press the button under **RESTART**. The camera displays the **SHUTTING DOWN** screen and reboots again.
11. The camera restarts displaying the V-RAPTOR 8K S35 start screen, the **INITIALIZING** screen, and then the Software License Agreement (SLA) displays:



12. Press the button under **Agree**. If you do not agree to the SLA, the camera cannot be used. The SLA continues to display until it is accepted.
13. Recalibrate the camera before recording. Refer to the [Calibration](#) section and [Calibrating the Sensor](#) for more information.

## UPGRADING THE DSMC3™ RED® TOUCH 7.0" LCD FIRMWARE

You can receive the best performance from your DSMC3™ RED® Touch 7.0" LCD monitor by installing the latest firmware. Make a habit of frequently visiting RED Downloads at [www.red.com/downloads](http://www.red.com/downloads) to check for new versions of DSMC3™ RED® Touch 7.0" LCD firmware, updated operation guides, and post-production software.

### UPDATING AUTOMATICALLY THROUGH THE CAMERA

When a newer firmware is detected on the camera, the DSMC3™ RED® Touch 7.0" LCD will prompt you on each boot to update the monitor. Follow the on-screen prompts to update the monitor.

### UPDATING MANUALLY THROUGH SmallHD

When a newer monitor firmware is available directly from SmallHD, there are two ways you can upgrade the DSMC3™ RED® Touch 7.0" LCD firmware.

#### UPGRADE DIRECTLY FROM THE DSMC3™ RED® TOUCH 7.0" LCD

1. Download the DSMC3™ RED® Touch 7.0" LCD upgrade .bin file directly from [downloads.smallhd.com](http://downloads.smallhd.com), to the root directory of a 2, 4, 8, or 16 GB SD card.
2. Insert the SD card in the monitor.
3. From the DSMC3™ RED® Touch 7.0" LCD Settings Panel, initiate the update.

#### UPGRADE THROUGH THE CAMERA

1. Download the DSMC3™ RED® Touch 7.0" LCD upgrade .bin file directly from [downloads.smallhd.com](http://downloads.smallhd.com).
2. Create a folder named "smallhd" on the root of the camera's CFexpress media card.
3. Copy the firmware file to the "smallhd" folder.
4. Insert the CFexpress card in the camera, and initiate the update through the Settings Panel of the DSMC3™ RED® Touch 7.0" LCD.

**NOTE:** This method requires that the monitor be on at least firmware version 5.0.0 to work. If the monitor is on OS4, use the *Directly from the DSMC3™ RED® Touch 7.0" LCD* firmware upgrade method.

## SYSTEM MAINTENANCE

All RED products are designed for rugged durability, but precision instruments demand proper care. Follow the instructions in this section to clean, maintain, and store your devices.

**WARNING:** DO NOT rinse or immerse the camera or other accessories in water. Keep dry at all times.

**WARNING:** DO NOT use soaps, detergents, ammonia, acetone, alkaline cleaners, abrasive cleaning compounds, or solvents. These substances may damage lens coatings and electronic circuitry.

**WARNING:** DO NOT use an excess of cleaning solution.

**WARNING:** DO NOT reuse swabs or wipes.

**WARNING:** DO NOT attempt to clean the sensor or optical cavity for any reason. If the sensor becomes dirty, submit a Support ticket at <https://support.red.com>.

**WARNING:** DO NOT attempt to modify, dismantle, or open the camera, lens, or other accessory as doing so may expose you to electric shock and serious injury. There are no user-serviceable parts inside. Alteration or repairs made to the camera or accessories, except by a RED authorized service facility, voids all warranties.

**WARNING:** Use caution with compressed air and gas dusters, since the high pressure, oily residue, cold air, particulates, and moisture may cause damage. You may use a filtered, non-residue gas duster to clean non-critical areas, such as around the fans and other recesses on the exterior of the camera. Damage to the camera or other components of the camera system caused by using compressed air or gas dusters is not covered under warranty.

**WARNING:** DO NOT use compressed air and gas dusters on the sensor or on any optics.

**WARNING:** DO NOT use compressed air and gas dusters on or around the integrated microphones on the front of the camera.

## EXTERIOR SURFACES

- Use a filtered, non-residue gas duster to clean non-critical areas, such as around the fans and other recesses on the exterior of the camera.
- Clean with a dry lint-free cloth. When cleaning your camera and accessories, remember that the devices are not waterproof and moisture can damage electronic circuitry.

## STORAGE

**WARNING:** DO NOT store the camera or accessories in any place with extreme temperatures, direct sunlight, high humidity, severe vibration, or strong magnetic fields.

## LCD SCREEN

This section explains how to clean the side LCD screen.

### Approved LCD Screen Cleaners

Use only the following products to clean the side LCD screen:

- Ionized rubber air bulb
- Lens swabs
- Dry optical wipes
- Delkin Devices Sensor Solution®

**NOTE:** Before cleaning the screen with swabs or wipes and a cleaning solution, ALWAYS use an ionized rubber air bulb to remove any solid particles. Cleaning the screen without removing solid particles increases the risk of scratching the screen.

### Prohibited LCD Screen Cleaners

DO NOT use any of the items listed below to clean the built-in LCD screen. These products have not been tested on RED products and may cause damage or streaking.

- Windex
- Solvents
- Gas dusters
- Compressed air
- Rubbing alcohol
- Isopropyl alcohol
- Third-party cleaning kits
- Pancro Professional Lens Cleaner (or equivalent)
- Pre-packaged lens cleaner containing any additives, such as detergent, anti-static compounds, or fragrance.

**WARNING:** Damage to the LCD screen or other components of the camera system caused by using prohibited cleaners is not covered under warranty.

## WATER DAMAGE

If your device has come in contact with water or you suspect camera water damage, submit a Support ticket at <https://support.red.com> immediately.

**WARNING:** DO NOT attempt to power any device that may have water damage.

**WARNING:** DO NOT place the device in a container of rice, silica gel, or desiccant packets in an attempt to dry the device.

## 6. TROUBLESHOOTING

### GENERAL TROUBLESHOOTING TIPS

This section describes general troubleshooting tips:

1. Confirm the Firmware version currently installed on your camera. Each firmware release contains bug fixes and other improvements. You may be experiencing a bug resolved in a later release.
  - You can find this under **Menu>System Settings>System Status>Camera Info**.
  - To confirm and download the latest firmware version, visit [red.com/downloads](https://red.com/downloads).
  - If your current firmware is out-of-date, please upgrade to the latest release build found on [red.com/downloads](https://red.com/downloads).
2. Reboot the camera by powering it off and back on.
3. Test the camera by installing an alternate or recently formatted CFexpress card.
4. Ensure that all of the cables and connections are fully seated and locked in place (if applicable).
5. Remove all attached accessories, RED and third-party. Ensure all contacts are clean, undamaged, and free of debris before remounting. Try booting the camera using the AC power adaptor without any accessories attached to determine whether the issue persists before reattaching any accessories.
6. Try rebooting the camera again after reattaching the accessories. If the camera boots without accessories and the symptom reoccurs after reattaching, try adding the accessories one at a time to isolate the root cause. This helps narrow down root causes to specific accessories and helps to ensure that a bad connection is not the source of the issues.
7. Perform a Reset Defaults. This will restore all camera settings back to factory default settings and reduce the possibility that applied settings caused the issue.

You can find this under **Menu>Maintenance>Reset Defaults**.

8. As a last resort, perform a Hard Restore. This will restore all camera settings back to factory default settings but goes a step further to clear camera internal memory.
  - a. Remove all attached accessories, RED and third-party, leaving only an AC power adaptor attached.
  - b. Turn the camera off.
  - c. Press and hold the REC button and at the same time switch the power ON.
  - d. Continue to hold the REC button until the camera finishes booting and the license agreement displays.

This completes the hard restore.





















### CONTACT SUPPORT



















If your camera continues to misbehave after you have performed these troubleshooting steps, submit a request for Technical Support. Include the following with the request:

- A detailed description of the issue and events that led up to its occurrence, including steps to replicate.
- A description of the rate of occurrence confirming whether the symptom is rare, intermittent, or continuous.
- A freshly saved camera Log File. The Log File can be saved through **Menu>Maintenance>Save Log**. Refer to [Save Log](#) for more information.
- Please confirm the firmware version currently installed. The firmware version number can be found under **Menu>System Settings>System Status>Camera Info**.
- A short video detailing the issue that is occurring, showing your camera setup and all attached accessories.
- Detailed list of accessories (RED and third-party), lens, and modules attached at the time the issue occurred.
- How were the camera and attached accessories powered when the issue first occurred?

## STATUS ICONS

The following is a table of the camera's status icons.

| ICON  | DETAILS   |
|---|---|
|    | The CFexpress media card is good and recording time remaining   |
|    | The CFexpress media card is missing   |
|    | The CFexpress media card is incompatible  |
|    | The sensor temperature (T) and exposure (E) calibration are good  |
|    | The sensor temperature (T) requires calibration   |
|    | The sensor exposure (E), or the sensor scan direction requires calibration  |
|    | Gray indicates that no Timecode generator signal is detected  |
|    | Green indicates that the Timecode source is connected and jammed  |
|   | Red indicates that the Timecode source is connected and not jammed  |
|  | White indicates that the selected Timecode source is not currently connected but was jammed during the current camera boot  |
|  | Yellow indicates that the selected Timecode source has not been jammed in current camera boot but has been within the last 12 hours, or that timecode source is cross-jammed (at a different <b>Project Time Base</b> ) |
|  | Gray indicates that no Genlock signal is detected   |
|  | Green indicates that the camera is receiving and is locked to a Genlock signal  |
|  | Red indicates that the camera is receiving and is not locked to a Genlock signal  |
|  | Gray indicates that no synchronization is detected  |
|  | Green indicates that the camera's sensor is synchronized with Timecode and that the camera's output is synchronized with a Genlock signal   |
|  | Yellow indicates that the camera is synchronized using Genlock but not timecode.  |
|  | Camera temperature is good. Camera operating as expected  |
|  | Camera is nearing overheated state. Consider cooling the camera   |
|  | Camera overheating. Camera has reached high temperature threshold and shut down is imminent   |
|  | Camera shutting down due to overheating   |

| ICON  | DETAILS  |
|---|--|
|    | Gray indicates that no network data transfer is occurring  |
|    | Green indicates that the camera is transferring FTPS or Cloud data   |
|    | Gray and open indicates that the camera LCD is unlocked  |
|    | White and closed indicates that the camera LCD is locked   |
|    | Gray and empty indicates that no Wi-Fi signal is detected  |
|    | White bars indicate the strength of the Wi-Fi signal detected (Infrastructure)   |
|    | White antenna indicates that Wi-Fi signal is broadcasting (Ad-hoc)   |
|    | Gray indicates that the camera is not connected to a network   |
|    | Green indicates that the camera is connected to a network  |
|    | Gray with gray NA indicates that no DC power is connected  |
|  | Green with white voltage numbers indicates that the camera is receiving DC power   |
|  | Green with flashing red voltage numbers indicates low DC power. The low power warning threshold is defined in the System Settings>Power menu |
|  | Gray indicates that no battery is connected  |
|  | White indicates that the battery is connected and green shows the relative level of charge remaining   |
|  | Yellow indicates 10 minutes of power remaining   |
|  | Red indicates less than 5 minutes of power remaining   |
|  | Gray question mark indicates no communication with the battery and no power  |
|  | White question mark indicates no communication with the battery and power  |
|  | Gray exclamation point indicates error communicating with the battery and no power   |



# A. MECHANICAL DRAWINGS

**NOTE:** Dimensions are shown in mm.

## FRONT VIEW

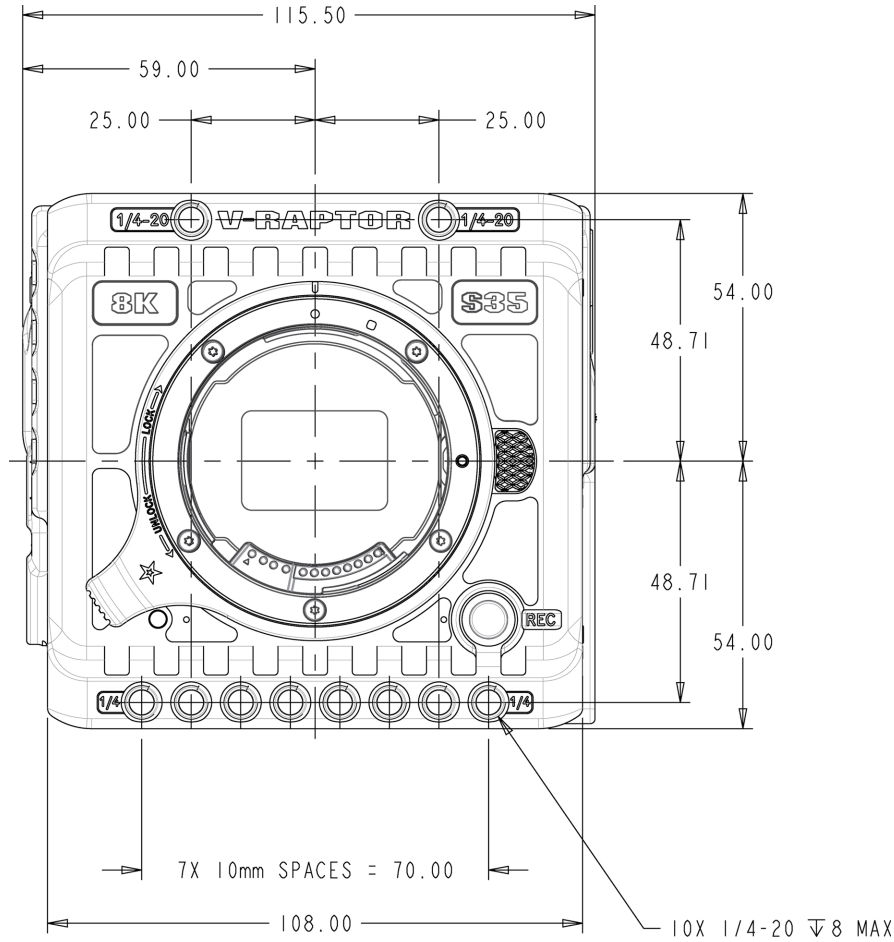
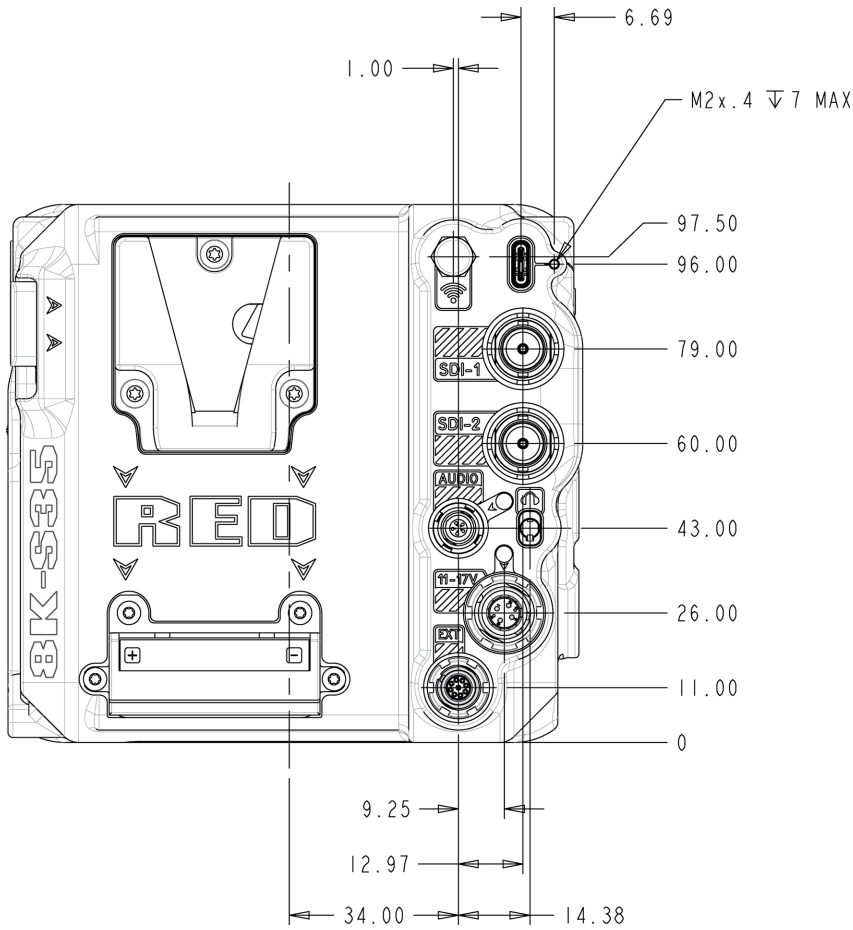

Figure: Camera Front View

## BACK VIEW



# RIGHT SIDE VIEW

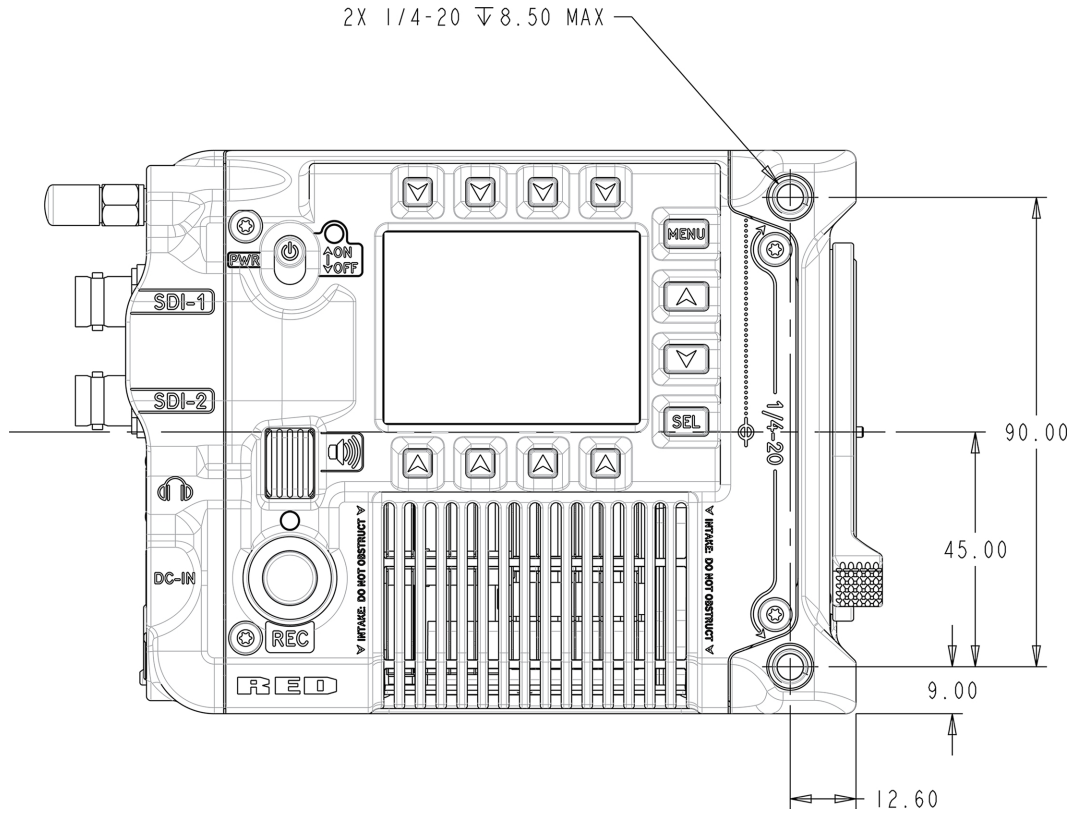

Figure: Camera Side View (Right)

## LEFT SIDE VIEW

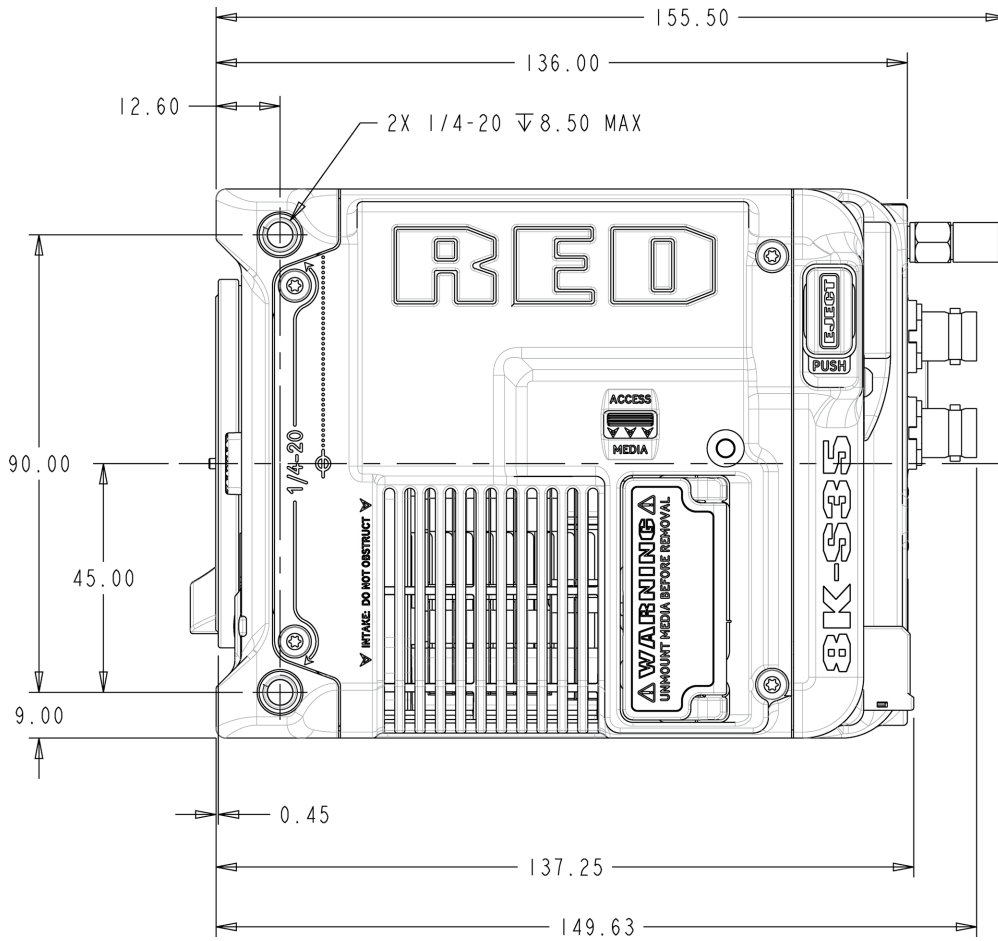

Figure: Camera Side View (Left)

**TOP VIEW**

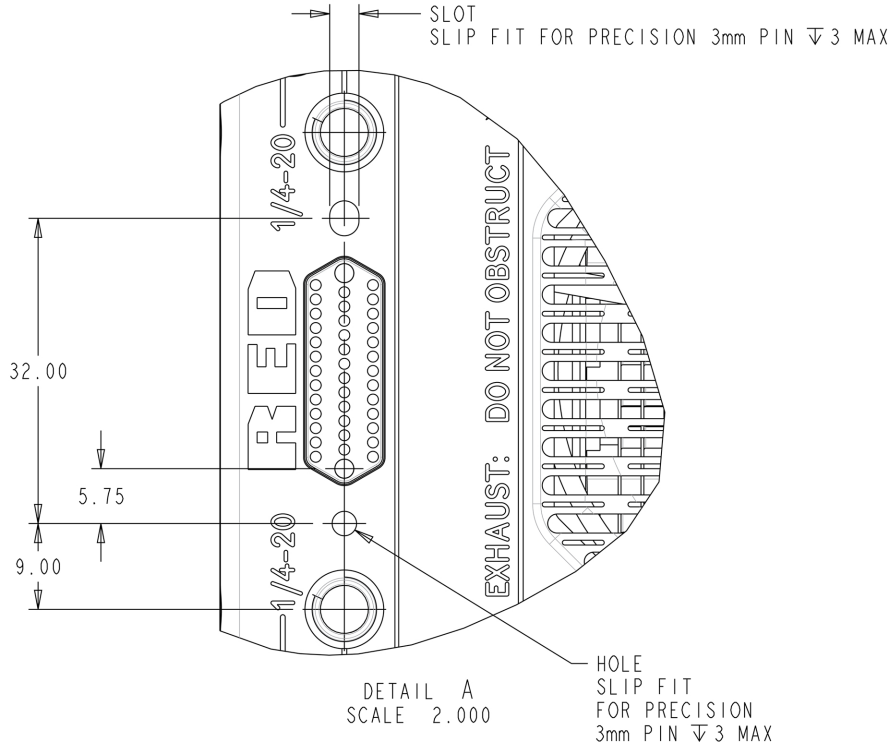
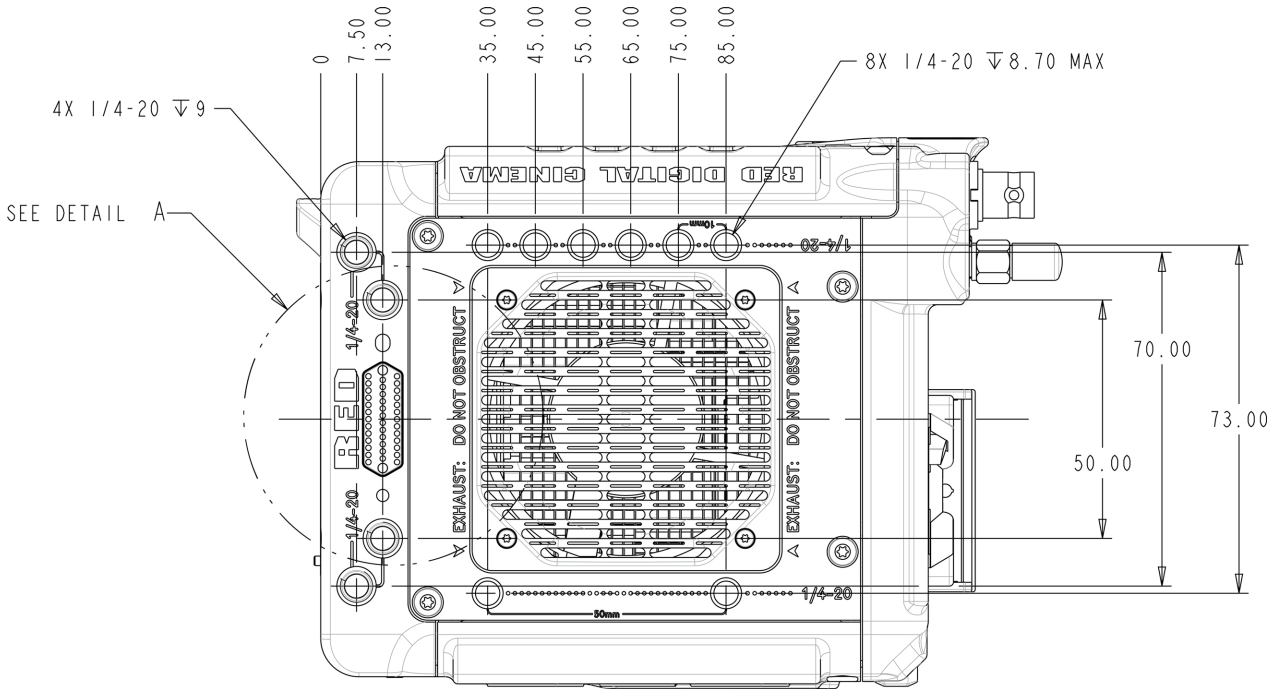

Figure: Camera Top View

## BOTTOM VIEW

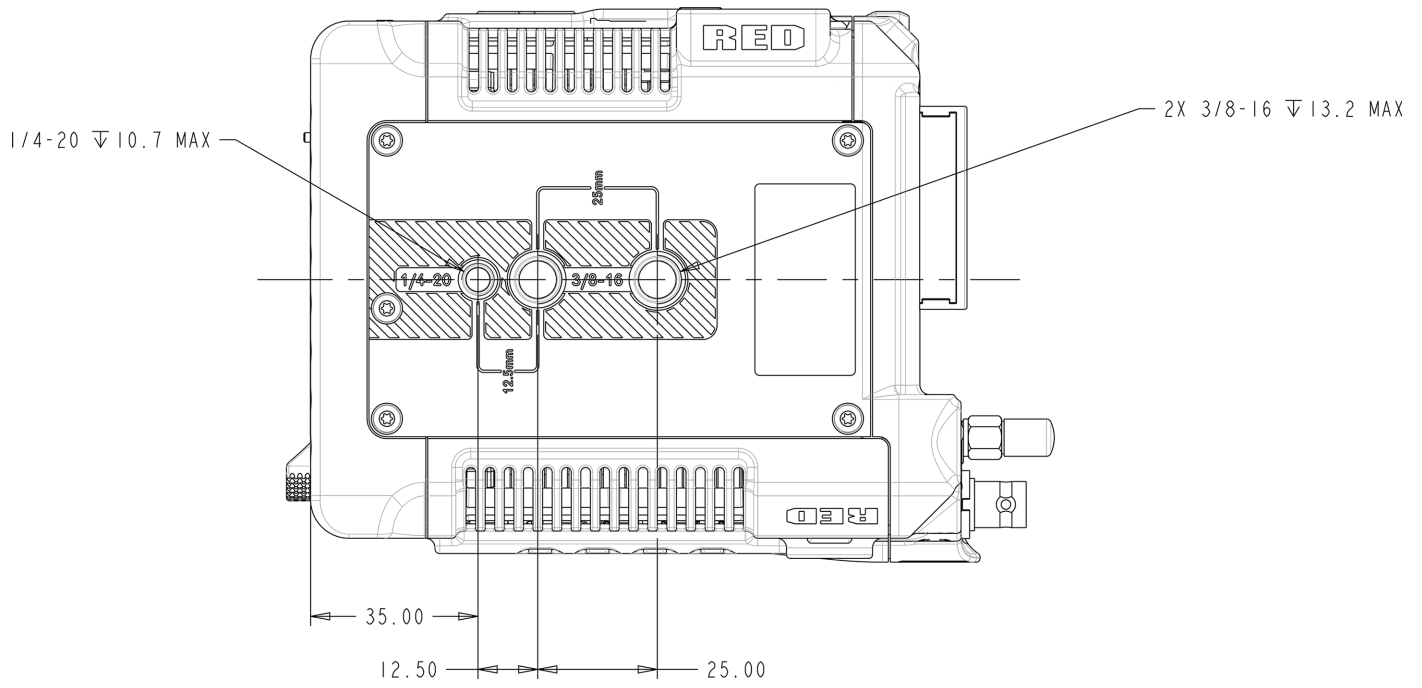
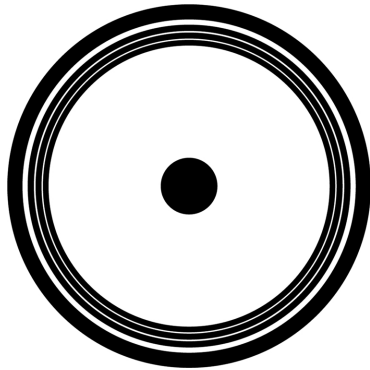

Figure: Camera Bottom View

## FEMALE RP SMA PORT

The female RP SMA connector provides an attachment for the male RP SMA Wi-Fi antenna.



*Figure: Front face of the female RP SMA port (looking at the back of the camera).*

**NOTE:** Mating connector is a Wi-Fi antenna with a standard male RP SMA connector.

## USB-C PORT



The USB-C port is used primarily for data connections. The USB-C port provides 5 volts at 0.5 amps.

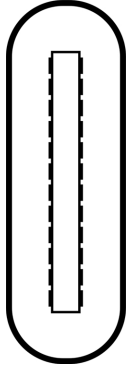

*Figure: Front face of the USB-C port (looking at the back of the camera).*

**NOTE:** Mating connector is a standard USB-C male connector.



## 12G-SDI (SDI-1 & SDI-2)



The 12G-SDI male 75-ohm BNC ports deliver 12, 6, 3, or 1.5 Gbps of image bandwidth ideal for the 4Kp60 format. Other features include:

- Up to Four (4) channels of embedded audio
- Time of Day and Edge Timecode
- Record Tally flag
- Clip name information (as SMPTE RP-188 VITC2 HANC metadata)

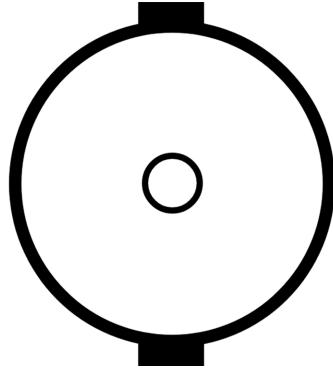

Figure: Front face of the 12G-SDI male BNC connector (looking at the back of the camera).

### 12G-SDI 75-OHM MALE BNC CONNECTOR

| PIN    | SIGNAL                  | DESCRIPTION   | DIRECTION |
|--------|-------------------------|---|-----------|
| Center | 12/6/3/1.5 G-SDI Signal | Up to 4096 x 2160: 422 for 60p - Log view or LUT view (SMPTE ST 2082) | Out       |
| Shell  | Ground                  | Common ground (camera ground)   | N/A       |

**NOTE:** Mating connector is standard 75-ohm female BNC connector rated for 12G-SDI.

**WARNING:** Under certain circumstances, it is possible for an SDI connector to incur damage when connected to an accessory and powered without using shielded cables. RED recommends only using high quality, shielded BNC cables that are rated for 12G-SDI signals and only using shielded power cables for powering SDI accessories.

Make sure power is connected to the SDI accessory at all times before you connect the BNC to the camera. Ungrounded power from SDI accessories can damage the camera's SDI port. To avoid this possible damage, attach the power source to the accessory before attaching it to the BNC cable. When using RED Approved Third Party battery plates, unplug the BNC cable prior to hot swapping.

When possible, avoid using P-Tap (also known as D-Tap) cables to power accessories. To avoid damage when using P-Tap/D-Tap, it's imperative that the connect/disconnect sequence (below) is followed precisely.

## **BNC ATTACHMENT INSTRUCTIONS**

When attaching SDI accessories:

1. Connect a power source to the SDI accessory; power on the SDI accessory.
2. Ensure a power source is connected to the camera. This ensures both are grounded prior to connecting the BNC. The camera's power state does not have an impact on SDI attachment sequence.
3. Connect the BNC cable to the accessory, then to the camera.

When detaching an accessory mounted to an SDI output, ensure that you remove the BNC connection to the camera before removing power to the SDI device:

1. Shutdown the SDI accessory.
2. Disconnect the BNC cable from the camera.
3. Disconnect the power source from the SDI accessory.

When you need to swap out a battery on an accessory mounted to the camera's SDI port, you must:

1. Shutdown the SDI accessory.
2. Disconnect the BNC cable from the camera.
3. Replace the battery on the SDI accessory.
4. Connect the BNC cable to the camera.
5. Power on the SDI accessory.

For more information about SDI safety, refer to [Preventing Damage to SDI Outputs](#).

## AUDIO PORT



The female LEMO 5-Pin 00B audio connector accepts 2-channel audio, Line, Mic, and +48V Phantom Power.

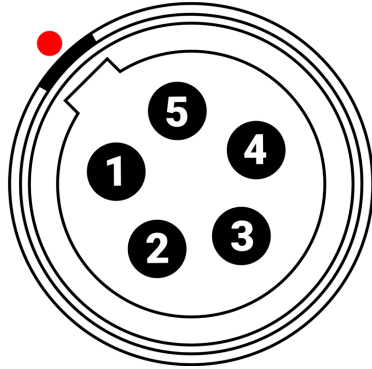

Figure: Front face of the female 5-Pin 00B audio connector (looking at the back of the camera).

### LEMO 5-PIN 00B FEMALE AUDIO CONNECTOR

| PIN | SIGNAL | DESCRIPTION                 |
|-----|--------|-----------------------------|
| 1   | Ground | Ground to camera            |
| 2   | Ch 3 + | Channel 3 signal (positive) |
| 3   | Ch 3 - | Channel 3 negative          |
| 4   | Ch 4 + | Channel 4 signal (positive) |
| 5   | Ch 4 - | Channel 4 negative          |

**NOTE:** Mating connectors are FGG.00.305.CLAD35Z (5-Pin 00 circular push-pull connector, straight plug) and FHG.00.305.CLAD35Z (5-Pin 00 circular push-pull connector, right-angle plug).

## HEADPHONE JACK

The female stereo 3.5 mm headphone jack provides an attachment for stereo headphones.

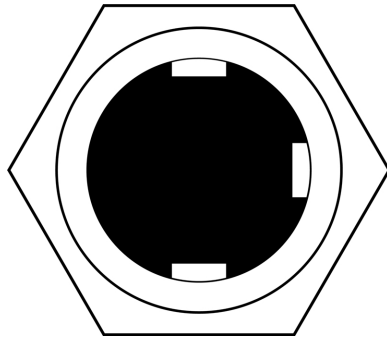

*Figure: Front face of the female 3.5 mm headphone jack (looking at the back of the camera).*

**NOTE:** Mating connector is a 3.5 mm stereo headphone plug.

## 6-PIN DC-IN



The male 6-Pin 1B DC-IN connector accepts DC input power from 11 V DC to 17 V DC. A built-in power conditioner protects against reverse-polarity connections, electrostatic discharge (ESD), undervoltage, overvoltage, and overcurrent.

**WARNING:** Both pairs of +VBATT and GROUND pins must be wired. Using a third-party power cable that wires only one (1) pair of +VBATT and GROUND pins may damage the power supply or the camera. Damage to the power supply or other components of the camera system caused by using an inappropriate power cable is not covered under warranty.

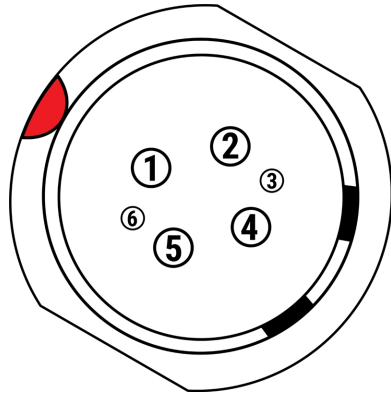

Figure: Front face of the male 6-Pin 1B DC power input connector (looking at the back of the camera).

## 6-PIN 1B DC INPUT CONNECTOR

| PIN | SIGNAL   | DESCRIPTION                      |
|-----|----------|----------------------------------|
| 1   | +VBATT   | Power input, +11.5 to +17 V DC   |
| 2   | +VBATT   | Power input, +11.5 to +17 V DC   |
| 3   | SCL-BATT | Battery SMBus SCL signal (3.3 V) |
| 4   | GROUND   | Power return (camera ground)     |
| 5   | GROUND   | Power return (camera ground)     |
| 6   | SDA-BATT | Battery SMBus SDA signal (3.3 V) |

**NOTE:** Mating connector is FGJ.1B.306.CWLD72Z.

## COMPATIBLE CABLES

- **790-0638:** DSMC AC Power Adaptor Pack
- **790-0164:** XLR Power Cable (10')
- **790-0291:** DSMC Battery Belt Clip

## EXTENSION PORT



The female 9-contact 0B ODU Extension port supports serial (RS-232 RX and TX), a General Purpose Input (GPI) trigger, General Purpose Output (GPO), Timecode, and Genlock. The connector also offers auxiliary 5-volt power out, with a maximum sustained current draw of 500 mA.

To operate the GPI contact closure style trigger, short Pin 6 (GPI) to Pin 9 (ground).

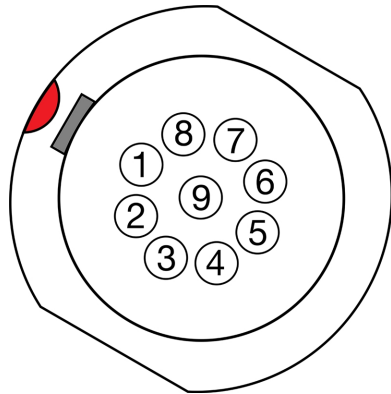

Figure: Front face of the female 9-contact Extension port (looking at the back of the camera).

**NOTE:** The required mating connector is 9-Pin 0L Straight Plug Connector (ODU, part# SX0L0X-P09MCC0-0001).

### 9-PIN 0B ODU EXTENSION PORT PINOUT

| PIN | SIGNAL       | DETAILS  |
|-----|--------------|--|
| 1   | 5 V AUX      | 5 Volt AUX (500 mA Max) enabled using the <b>Power</b> menu                              |
| 2   | Timecode Out | Timecode Out – SMPTE 12M <sup>1</sup>  |
| 3   | GPO          | General Purpose Out: Recording Indicator Out, Sensor Sync Out using 3.3 volt logic level |
| 4   | UART TX      | Serial RS-232 transmit   |
| 5   | UART RX      | Serial RS-232 receive  |
| 6   | GPI (R/S)    | Pull to ground (pin 9) to start/stop record <sup>2</sup>                                 |
| 7   | Timecode In  | Timecode In – SMPTE 12M  |
| 8   | Genlock      | Tri-Level Genlock In (SMPTE 296M and 274M)   |
| 9   | GND          | Signal and power ground  |

1. Not currently supported.

2. The signal path includes a resistor pulling the signal high, which is designed to work with a closure switch connected to ground.

## CONTACT CLOSURE STYLE TRIGGER BUTTON CIRCUIT

The diagram below shows the contact closure style trigger button circuit on the EXT port connector.

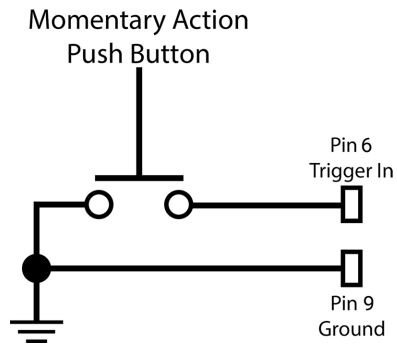

## COMPATIBLE CABLES

- **790-0685:** RED 9-Pin EXT to Flying Lead 1.3'
- **790-0674:** RED EXT to Timecode 3'

# B. MENU MAP

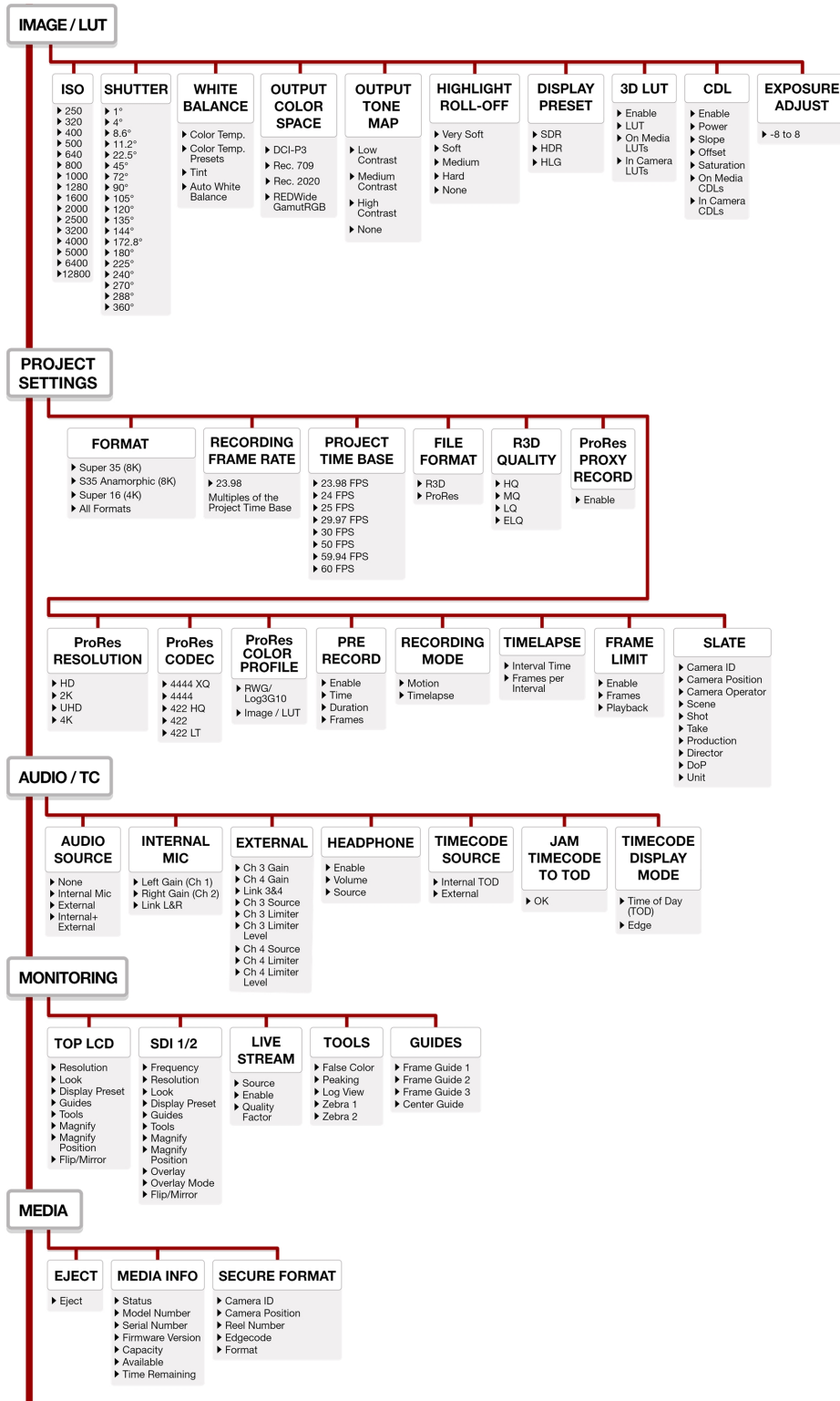



# V-RAPTOR™ 8K S35 OPERATION GUIDE

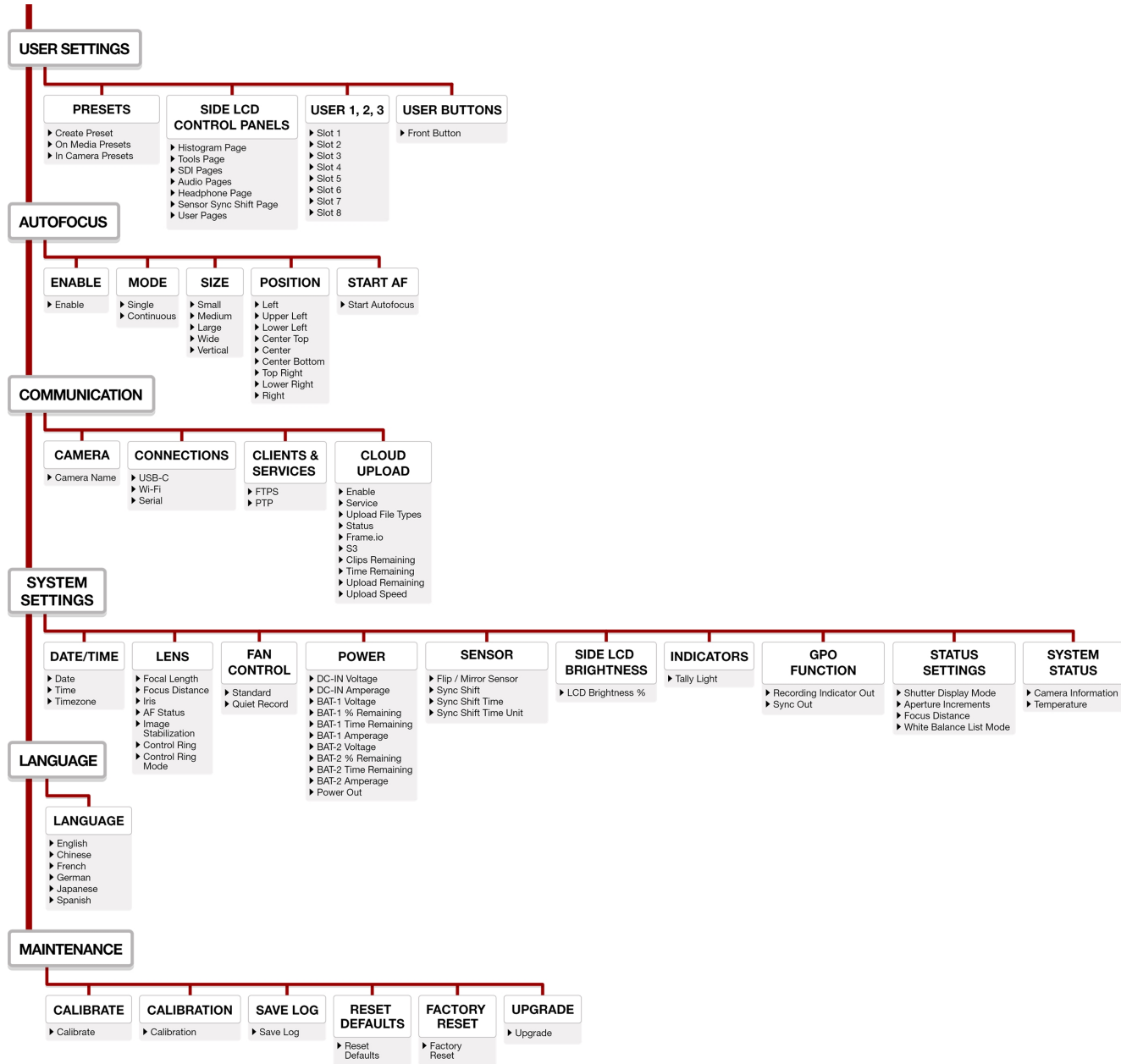

## C. TECHNICAL SPECIFICATIONS

Technical specifications reflect both current and projected information. Everything is subject to change.

| <b>V-RAPTOR™ 8K S35</b>                      |  |
|--|--|
| <b>ITEM</b>                                  | <b>DETAILS</b>   |
| Sensor Type                                  | V-RAPTOR 8K S35 35.4 Megapixel CMOS  |
| Effective Pixels                             | 8192 x 4320  |
| Sensor Size                                  | 26.21 mm x 13.82 mm (Diagonal: 29.63 mm)   |
| Dynamic Range                                | 16.5+ stops  |
| Mount Type                                   | Integrated RF mount with RF lens support<br>Supports Canon EF lenses by using compatible Canon RF to EF mount adapters<br>Accepts other Canon RF mount-based lens adapters for diverse lens choices <sup>1</sup>   |
| Max Data Rates                               | Up to 800 MB/s using RED branded or other qualified CFexpress media cards <sup>1</sup>   |
| REDCODE®<br>RAW<br>Maximum<br>Frame<br>Rates | Super 35<br>120 fps at 8K 17:9 (8192 x 4320), 150 fps at 8K 2.4:1 (8192 x 3456)<br>140 fps at 7K 17:9 (7168 x 3780), 175 fps at 7K 2.4:1 (7168 x 3024)<br>160 fps at 6K 17:9 (6144 x 3240), 200 fps at 6K 2.4:1 (6144 x 2592)<br>192 fps at 5K 17:9 (5120 x 2700), 240 fps at 5K 2.4:1 (5120 x 2160)<br>Super 16<br>240 fps at 4K 17:9 (4096 x 2160), 300 fps at 4K 2.4:1 (4096 x 1728)<br>320 fps at 3K 17:9 (3072 x 1620), 400 fps at 3K 2.4:1 (3072 x 1296)<br>480 fps at 2K 17:9 (2048 x 1080), 600 fps at 2K 2.4:1 (2048 x 864) |
| Playback Frame Rates<br>(Project Time Base)  | 23.98, 24, 25, 29.97, 30, 50, 59.94, 60 fps, at all resolutions  |
| Best Available<br>REDCODE®<br>Settings       | REDCODE HQ, MQ, and LQ at 8K 17:9 (8192 x 4320) up to 60 fps<br>REDCODE LQ at 8K 17:9 (8192 x 4320) up to 120 fps<br>REDCODE HQ, MQ, and LQ at 6K 17:9 (6144 x 3240) up to 96 fps<br>REDCODE MQ, and LQ at 6K 17:9 (6144 x 3240) up to 160 fps<br>REDCODE HQ, MQ, and LQ at 4K 17:9 (4096 x 2160) up to 240 fps<br>REDCODE HQ, MQ, and LQ at 2K 17:9 (2048 x 1080) up to 480 fps   |
| REDCODE RAW<br>Acquisition Formats           | 8K 17:9 (8192 x 4320), 2:1, 2.4:1, 16:9, 1:1 and Anamorphic 2x, 1.8x, 1.6x, 1.5x, 1.3x, 1.25x<br>7K 17:9 (7168 x 3780), 2:1, 2.4:1, 16:9, 1:1<br>6K 17:9 (6144 x 3240), 2:1, 2.4:1, 16:9, 1:1<br>5K 17:9 (5120 x 2700), 2:1, 2.4:1, 16:9, 1:1<br>4K 17:9 (4096 x 2160), 2:1, 2.4:1, 16:9, 1:1<br>3K 17:9 (3072 x 1620), 2:1, 2.4:1, 16:9, 1:1<br>2K 17:9 (2048 x 1080), 2:1, 2.4:1, 16:9, 1:1  |
| Apple® ProRes                                | Dedicated recording in ProRes 4444 XQ, ProRes 4444, ProRes 422 HQ, ProRes 422, and ProRes 422 LT, with resolutions up to 4K (4096 x 2160) 120P<br>Proxy recording available up to ProRes 422 HQ in 2K (2048 x 1080) up to 60P  |
| Construction                                 | Aluminum Alloy   |
| Weight                                       | 4.0 lb without the body cap and the CFexpress card   |
| Dimensions                                   | L: 6 inches, W: 4.25 inches, H: 4.25 inches  |
| Battery Type                                 | Integrated V-Lock battery interface optimized for the Micro V-Lock batteries <sup>1</sup>  |
| DC Power                                     | +11 to +17 volts DC using the integrated 6-Pin DC-IN port  |
| Operating Temperature                        | 0° C to 40° C (32° F to 104° F)  |

## V-RAPTOR™ 8K S35

| ITEM                | DETAILS  |
|---------------------|--|
| Storage Temperature | -20° C to 50° C (-4° F to 122° F)  |
| Relative Humidity   | 0% to 85% non-condensing   |
| Color Management    | Image Processing Pipeline 2 (IPP2)<br>Supports 33×33×33 3D LUTs<br>Supports import of CDLs   |
| Audio               | Integrated dual channel digital mono scratch microphones, uncompressed, 24-bit 48 kHz<br>Integrated dual channel mic/line/+48 V input through the 5-Pin Audio Port, uncompressed, 24-bit 48 kHz  |
| Autofocus           | Phase detection and contrast   |
| Remote Control      | Wi-Fi for camera control through interchangeable male RP SMA antenna to female RP SMA connection. Genlock, Timecode In, GPIO and Ctrl (RS-232) using the integrated 9-Pin EXT Port. Wired control using the USB-C port or Gigabit Ethernet (compatible USB-C to Ethernet adapter <sup>1</sup> required) allowing remote camera control, live MJPEG preview video feed, and remote media offload                                |
| Monitor Outputs     | Proprietary Top Accessory Port for Monitoring and Control<br>Integrated dual 12G-SDI with 6G-SDI, 3G-SDI, and 1.5G-SDI modes with 10-bit 4:2:2 bit depth<br>12G-SDI: Up to 4096 × 2160 4:2:2 for 60p<br>6G-SDI: Up to 4096 × 2160 4:2:2 for 30p, 25p, and 24p<br>3G-SDI: Up to 2048 × 1080 4:2:2 for 60p<br>1.5G-SDI: Up to 2048 × 1080 4:2:2 for 30p, 25p, and 24p<br>SMPT E Timecode, HANC metadata, and 24-bit 48 kHz audio |
| Monitor Options     | DSMC3™ RED® Touch 7" LCD (top LCD)<br>IP streamed 1080p live preview wirelessly, or wired over USB-C<br>Integrated 2.4" LCD for camera control (no preview video)  |

## SOFTWARE

|                     |  |
|---------------------|--|
| RED Control App     | Access full camera controls and live preview from iOS or Android devices<br>Available from the Apple App Store and Google Play Store. RED Control works wirelessly or wired through the USB-C port |
| RED Control Pro App | Access professional camera controls and live preview from iOS devices<br>Purchase a license through RED Digital Cinema<br>RED Control works wirelessly, or wired through the USB-C port            |

1. For more information on accessories, refer to [RED.com/third-party-accessories](https://www.red.com/third-party-accessories)

## D. ACCESSORIES

The following is a list of camera accessories. Some are optional, depending on the package you purchase:

- CFexpress Type B Media
- REDVOLT Batteries
- RED® Compact Chargers
- V-RAPTOR™ Power Adaptor
- DSMC3™ RED® Touch 7.0" LCD
- DSMC3™ RED® Touch 7.0" LCD Hood
- DSMC3™ RMI Cables
- V-RAPTOR™ Top Handle and Extensions
- V-RAPTOR™ Wing Grip
- Outrigger Handle
- RED® Production Grips
- V-RAPTOR™ Side Ribs
- V-RAPTOR™ Expander Blade
- DSMC3™ RED® 5-Pin to Single 3.5 mm Adapter
- DSMC3™ RED® 5-Pin to Dual XLR Adapter
- RED® RF to PL Adapter Pack
- V-RAPTOR™ Quick Release Platform Pack
- V-RAPTOR™ Tactical Top Plate and Battery Adapter (V-Lock or Gold Mount)



## CFEXPRESS TYPE B MEDIA



The RED CFexpress Type B Media provides the camera with 660 gigabyte, 1.3, 2, and 4 terabyte recording options. The 2 TB and 660 GB cards use the same hardware as do the 1.3 TB and 4 TB. The differences come from the software and firmware, which configure the media differently to prioritize different feature sets. The 2 TB and 4 TB prioritize capacity while still providing excellent durability under normal use. The 660 GB and 1.3 TB are in an overprovisioned configuration of the same media to prioritize extended write cycles and improved thermal performance for constant writing and re-writing of data. The underlying hardware is identical.

| ITEM                             | DETAILS                           |
|----------------------------------|-----------------------------------|
| Type                             | CFexpress Type B Media            |
| Capacity - 660 GB High Endurance | 660,138,909,696 bytes             |
| Capacity - 1.3 TB High Endurance | 1,331,512,536,141 bytes           |
| Capacity - 2 TB High Capacity    | 2,048,480,824,832 bytes           |
| Capacity - 4 TB High Capacity    | 4,096,961,649,664 bytes           |
| Operating temperature            | 14° F to 158° F (-10° C to 70° C) |
| Operating humidity               | 5% to 95%, non-condensing         |
| Storage temperature              | -4° F to 185° F (-20° C to 85° C) |
| Shock resistance (operating)     | 50 g                              |
| Vibration resistance (operating) | 15 g at 10 Hz to 2000 Hz          |
| Weight                           | Approximately 0.25 oz (7.1 g)     |
| Dimensions                       | Height: 1.52 in. (38.5 mm)        |
|                                  | Width: 1.17 in. (29.6 mm)         |
|                                  | Depth: 0.15 in. (3.8 mm)          |

## RED® CFEXPRESS TYPE B READER

The RED CFexpress Type B Card Reader provides a fast USB-C connection with the capability of write-protect.

Set the Write-Protect switch to the Lock position to prevent connected devices from adding any unwanted data to your CFexpress Type B card.



| ITEM       | DETAILS                             |
|------------|-------------------------------------|
| Media read | CFexpress Type B                    |
| Interface  | USB-C 3.2 cable to CFexpress Type B |
| Power      | USB bus power                       |
| Cable      | USB-C 3.2 cable type A to C adapter |
| Weight     | Approximately 4.2 oz (120 g)        |
| Dimensions | Height: 3.74 in. (95 mm)            |
|            | Width: 2.56 in. (65 mm)             |
|            | Depth: 0.47 in. (12 mm)             |

## REDOVOLT BATTERIES

### REDOVOLT MICRO-V BATTERY

The REDVOLT MICRO-V 14.7 volt V-Lock battery includes an LED charge level indicator, a P-tap port, and a USB power port.



| ITEM                  | DETAILS                          |
|-----------------------|----------------------------------|
| Type                  | Rechargeable Lithium-Ion Battery |
| Capacity              | 6600 mAh / 98 Wh                 |
| Battery output        | 14.8 V DC                        |
| P-tap output          | 12 V DC                          |
| USB output            | 5 V DC (3 amps)                  |
| Maximum load          | 12 Amps at 14 V DC               |
| Operating temperature | 50° F ~ 113° F (10° C ~ 45° C)   |
| Charging temperature  | 32° F ~ 104° F (0° C ~ 40° C)    |
| Storage temperature   | 68° F ~ 122° F (20° C ~ 50° C)   |
| Charger               | RED Compact Dual V-Lock charger  |
| Weight                | Approximately 1.2 lb (544.3 g)   |
| Dimensions            | Height: 3.93 in. (99.8 mm)       |
|                       | Width: 2.82 in. (71.6 mm)        |
|                       | Depth: 1.94 in. (49.3 mm)        |

### COMPATIBLE BATTERIES

Compatible batteries are those that provide enough current (14.4 V with 8 A or greater) to power the RED V-RAPTOR, and that also fit the dimensions on the V-RAPTOR's integrated Micro V-Lock plate.

RED chose the Micro V-Lock for the V-RAPTOR to keep its form-factor compact. As a result, not all V-Lock batteries are compatible with the camera.

#### NOTE:

- V-Lock batteries with a width greater than 2.95 in. (75 mm) are not compatible with the camera's Micro V-Lock plate and will require the battery adapter.
- The camera can charge a battery that supports SMBus communication directly. To charge the battery, the camera must be powered off while connected to DC-IN power. You can also use the optional RED Compact Dual V-Lock charger.

## REDOVOLT MICRO-G BATTERY

The REDVOLT Micro-G 14.7 volt Gold Mount battery includes an LED charge level indicator, a P-tap port, and a USB power port. V-RAPTOR requires the V-RAPTOR™ Tactical Top Plate and Gold Mount Battery Adapter to allow you to use Gold Mount batteries (refer to [V-RAPTOR™ Tactical Top Plate and Battery Adapter \(V-Lock or Gold Mount\)](#) for more information).



| ITEM                  | DETAILS                             |
|-----------------------|-------------------------------------|
| Type                  | Rechargeable Lithium-Ion Battery    |
| Capacity              | 6600 mAh / 98 Wh                    |
| Battery output        | 14.8 V DC                           |
| P-tap output          | 12 V DC                             |
| USB output            | 5 V DC (3 amps)                     |
| Maximum load          | 12 amps at 14 V DC                  |
| Operating temperature | 50° F ~ 113° F (10° C ~ 45° C)      |
| Charging temperature  | 32° F ~ 104° F (0° C ~ 40° C)       |
| Storage temperature   | 68° F ~ 122° F (20° C ~ 50° C)      |
| Charger               | RED Compact Dual Gold Mount charger |
| Weight                | Approximately 1.2 lb (544.3 g)      |
| Dimensions            | Height: 3.93 in. (99.8 mm)          |
|                       | Width: 2.82 in. (71.6 mm)           |
|                       | Depth: 1.94 in. (49.3 mm)           |

Use the optional RED Compact Dual Gold Mount charger for recharging the REDVOLT Micro-G batteries.



## RED® COMPACT CHARGERS

### RED® COMPACT DUAL V-LOCK CHARGER

The optional RED Compact Dual V-Lock charger allows you to charge two REDVOLT MICRO-V batteries.



| ITEM                  | DETAILS                                    |
|-----------------------|--|
| Input                 | 100 V - 240 V AC 50 Hz to 60 Hz            |
| Charge current        | One battery 3 Amps, two batteries 1.5 Amps |
| Charging temperature  | 32° F ~ 104° F (0° C ~ 40° C)              |
| Storage temperature   | 68° F ~ 122° F (20° C ~ 50° C)             |
| Battery compatibility | REDVOLT MICRO-V 14.7 V DC                  |
| Weight                | Approximately 1 lb (453.5 g)               |
| Dimensions            | Height: 4.5 in. (114.3 mm)                 |
|                       | Width: 5.5 in. (139.7 mm)                  |
|                       | Depth: 3 in. (76.2 mm)                     |

## RED® COMPACT DUAL GOLD MOUNT CHARGER

The optional RED® Compact Dual Gold Mount charger allows you to charge two REDVOLT MICRO-G batteries.



| ITEM                  | DETAILS                                    |
|-----------------------|--|
| Input                 | 100 V - 240 V AC 50 Hz to 60 Hz            |
| Charge current        | One battery 3 Amps, two batteries 1.5 Amps |
| Charging temperature  | 32° F ~ 104° F (0° C ~ 40° C)              |
| Storage temperature   | 68° F ~ 122° F (20° C ~ 50° C)             |
| Battery compatibility | REDVOLT MICRO-G 14.7 V DC                  |
| Weight                | Approximately 1 lb (453.5 g)               |
| Dimensions            | Height: 4.5 in. (114.3 mm)                 |
|                       | Width: 5.5 in. (139.7 mm)                  |
|                       | Depth: 3 in. (76.2 mm)                     |

## V-RAPTOR™ POWER ADAPTOR



The V-RAPTOR 150-Watt AC power adaptor connects to the camera's port to provide DC power for operating the camera and for recharging the attached REDVOLT Batteries.

The camera charges the batteries when the camera is off and the power adaptor is connected.

## DSMC3™ RED® TOUCH 7.0" LCD



The optional DSMC3™ RED Touch 7.0" LCD offers an HD viewing experience for recording and viewing footage on the V-RAPTOR™ camera. A 1920 x 1200 resolution display panel with peak brightness of 1300 nits and high pixel density (at 322 ppi), not only provides the optimal experience when viewing footage, but also features 100% DCI-P3 color gamut coverage for tremendous color accuracy.

This monitor also features full control over the camera through the new responsive menu system powered by SmallHD PageOS. The features include Waveform, Vectorscope, Histogram, False Color, Color Picker, Pixel Zoom, and more.

The lightweight display mounts to a removable integrated tilt arm with the capability to rotate 180 degrees for versatile mounting options.

It also boasts the latest generation pogo pins to provide power and video to the monitor, and the ability to connect through a single-locking USB-C-style DSMC3™ RMI cable for video and power. No additional SDI or power cables are needed.

Refer to [RED Monitor Interface Cable](#) for more information.

**NOTE:** The USB-C-style DSMC3™ RMI cable is not a standard USB-C cable. The DSMC3™ RED Touch 7.0" LCD is not compatible with DSMC®, DSMC2®, RED RANGER® or KOMODO® camera systems.

For more information, refer to the [DSMC3™ RED® Touch 7.0" LCD User Guide](#).

## SPECIFICATIONS

| ITEM          | DETAILS        |
|---------------|----------------|
| Material      | Aluminum alloy |
| Resolution    | 1920 x 1200    |
| Pixel density | 322 ppi        |
| Refresh rate  | 60 Hz          |
| Response time | 25 ms          |
| Contrast      | 1250:1         |
| Brightness    | 1300 cd/m2     |

| ITEM                                   | DETAILS   |
|--|---|
| Color depth                            | 10-bit  |
| Colors                                 | 100% DCI-P3   |
| Viewing angle                          | ± 160° all axes   |
| Display orientation                    | Landscape, 180° rotation  |
| Touch                                  | pCap Multi-Touch  |
| Camera connection                      | Power and communication through the RMI cable   |
| Mounting                               | 15 mm rail  |
| Hood Mounting                          | 4 x M3 mounting points  |
| Buttons                                | 4 buttons function 1, 2, 3 & 4  |
| EXP Ports                              | For future use, not currently supported   |
| Power consumption                      | 15.5 Watts  |
| Operating temperature                  | 32° F to 104° F (0° C to 38° C)   |
| Storage temperature                    | -0° F to 120° F (-18° C to 49° C)   |
| Operating humidity                     | 0% to 85%, non-condensing   |
| Storage humidity                       | 0% to 85%, non-condensing   |
| Firmware requirement                   | Compatible with V-RAPTOR firmware version 1.1 or later  |
| Monitor dimensions                     | Weight approximately 1.25 lb (568.0 g)<br>Height: 4.67 in. (118.70 mm)<br>Width: 7.09 in. (180.10 mm)<br>Depth: 1.13 in. (28.80 mm) |
| Arm dimensions                         | Weight approximately 0.07 lb (30.1 g)<br>Height: 1.18 in. (30.00 mm)<br>Width: 2.40 in. (61.00 mm)<br>Depth: 0.70 in. (17.50 mm)    |
| RED Monitor Interface (RMI) dimensions | Weight approximately 0.28 lb (126 g)<br>Height: 1.67 in. (42.50 mm)<br>Width: 4.25 in. (108.00 mm)<br>Depth: 1.51 in. (38.23 mm)    |

## DSMC3™ RED® TOUCH 7.0" LCD HOOD



The DSMC3™ RED® Touch 7.0" LCD Hood attaches easily and directly to the DSMC3™ RED® Touch 7.0" LCD and can block out the sun to make viewing the LCD easier in bright conditions.

**COMPATIBILITY:** The DSMC3™ RED® Touch 7.0" LCD Hood is only compatible with the DSMC3™ RED® Touch 7.0" LCD.

## DSMC3™ RMI CABLES



The DSMC3™ RMI cables are available in longer lengths including 10 inches (25 cm), 18 inches (49 cm), and 39 inches (1 m). This allows you to mount the **DSMC3™ RED® Touch 7.0" LCD** further from the camera.

**790-0702:** DSMC3™ RMI Cable 10"

**790-0713:** DSMC3™ RMI Cable 18"

**790-0703:** DSMC3™ RMI Cable 39"

## V-RAPTOR™ TOP HANDLE AND EXTENSIONS



The V-RAPTOR™ Top Handle easily mounts to the **V-RAPTOR™ Top Handle and Extensions** while offering a combination of comfort and utility for carrying or shooting clips with your camera. This top-mounted machined handle features ergonomic Bocote wood inlays with camera trigger control. It also can be configured in multiple ways when used with the Top Handle Extension Kit and includes multiple 1/4-20 and 3/8-16 threads.

The Top Handle and Extension kit includes:

- V-RAPTOR Top Handle



- 1" Top Handle Extension Piece



- 3" Top Handle Extension Piece



- 5" Top Handle Extension Piece



- Elbow Piece



- 15 mm Monitor Mount



**NOTE:** The V-RAPTOR™ Tactical Top Plate and Battery Adapter (V-Lock or Gold Mount) is required to secure the V-RAPTOR™ Top Handle Support Arm to the camera. The V-RAPTOR™ Top Handle extensions should only be used in conjunction with the Top Handle Rear Support Arm (included with the V-RAPTOR™ Top Handle) to provide sufficient support to the Top Handle.

For issues or troubleshooting, contact [support@cs.inc](mailto:support@cs.inc)

**COMPATIBILITY:** The V-RAPTOR™ Top Handle is not compatible with DSMC®, DSMC2® or RED RANGER® camera systems.

## INSTALLING THE TOP HANDLE

The versatile V-RAPTOR™ Top Handle allows you to create a myriad of configurations for gripping your V-RAPTOR. Here we present a few versions to give you a some ideas.

- Top Handle mounted to the V-RAPTOR body
- Top Handle mounted to the Tactical Top Plate
- Monitor mounted to the front of the Top Handle



## INSTALLING THE TOP HANDLE ON THE V-RAPTOR

To install the Top Handle on the top of the V-RAPTOR body:

1. Align the Top Handle hex bolts with the top 1/4-20 mounting holes on the top front of the V-RAPTOR body.
2. Tighten the two hex bolts to the V-RAPTOR body.

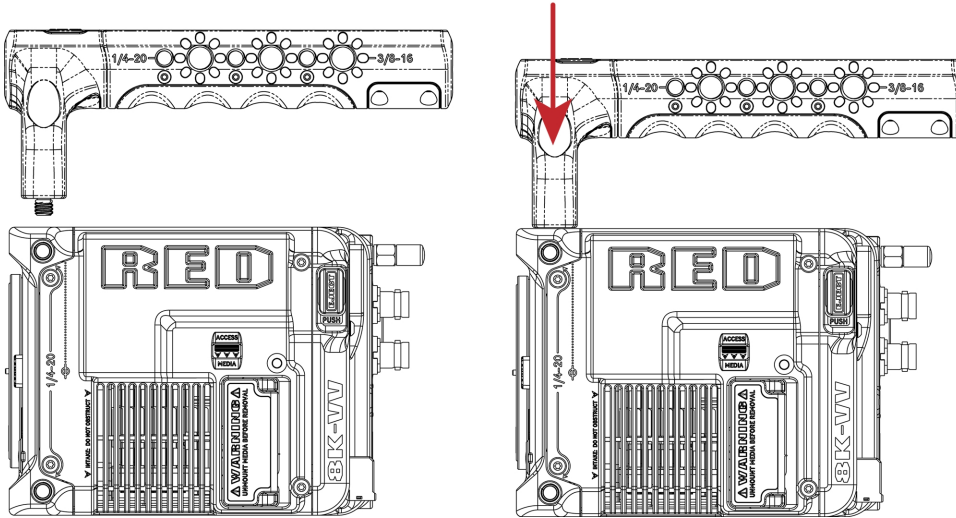

## INSTALLING THE TOP HANDLE ON THE V-RAPTOR WITH V-RAPTOR™ TACTICAL TOP PLATE

To install the Top Handle on the Tactical Top Plate:

1. Align the Top Handle hex bolts with the top 1/4-20 mounting holes in the Tactical Top Plate.
2. Tighten the three hex bolts to the Tactical Top Plate.

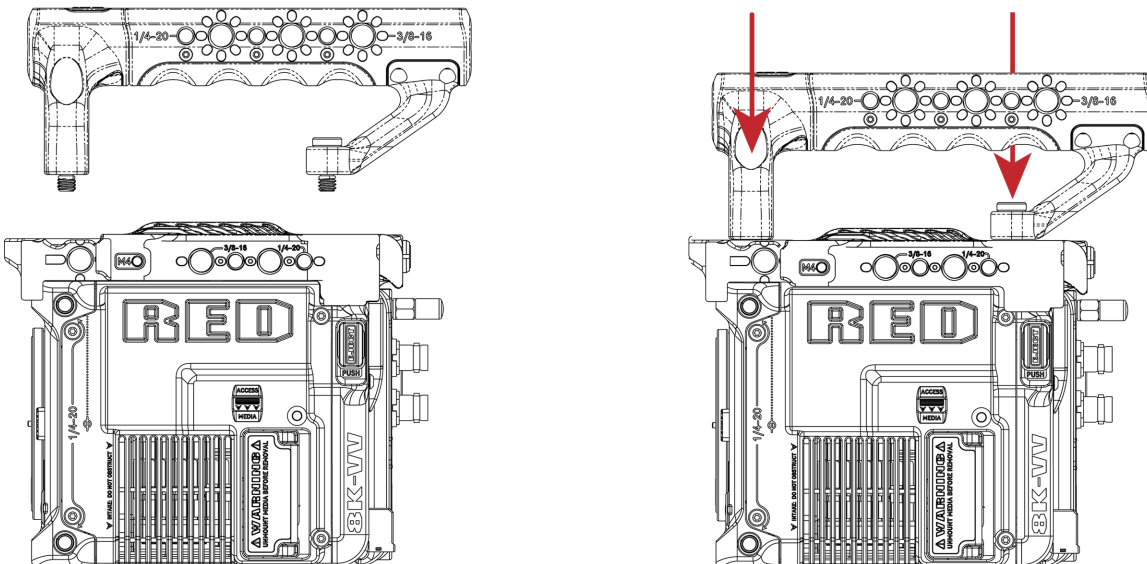

## INSTALLING THE **DSMC3™ RED® TOUCH 7.0" LCD** ON THE TOP HANDLE

To install the RED Touch LCD to the Top Handle:

1. Align a Top Handle Extension (1" extension shown here) with front of the Top Handle.
2. Tighten the hex bolt to the Top Handle.
3. Align the 15 mm Monitor Mount extension bolt with the side 3/8-16 mount hole of the Top Handle extension.
4. Tighten the Monitor Mount bolt to the Top Handle extension.
5. Align the 15 mm hole on the Monitor rail to the 15 mm Monitor Mount.
6. Slip the 15 mm Monitor rail collar over the 15 mm Monitor mount post and tighten the knurled knob on the Monitor rail to the desired monitor position.

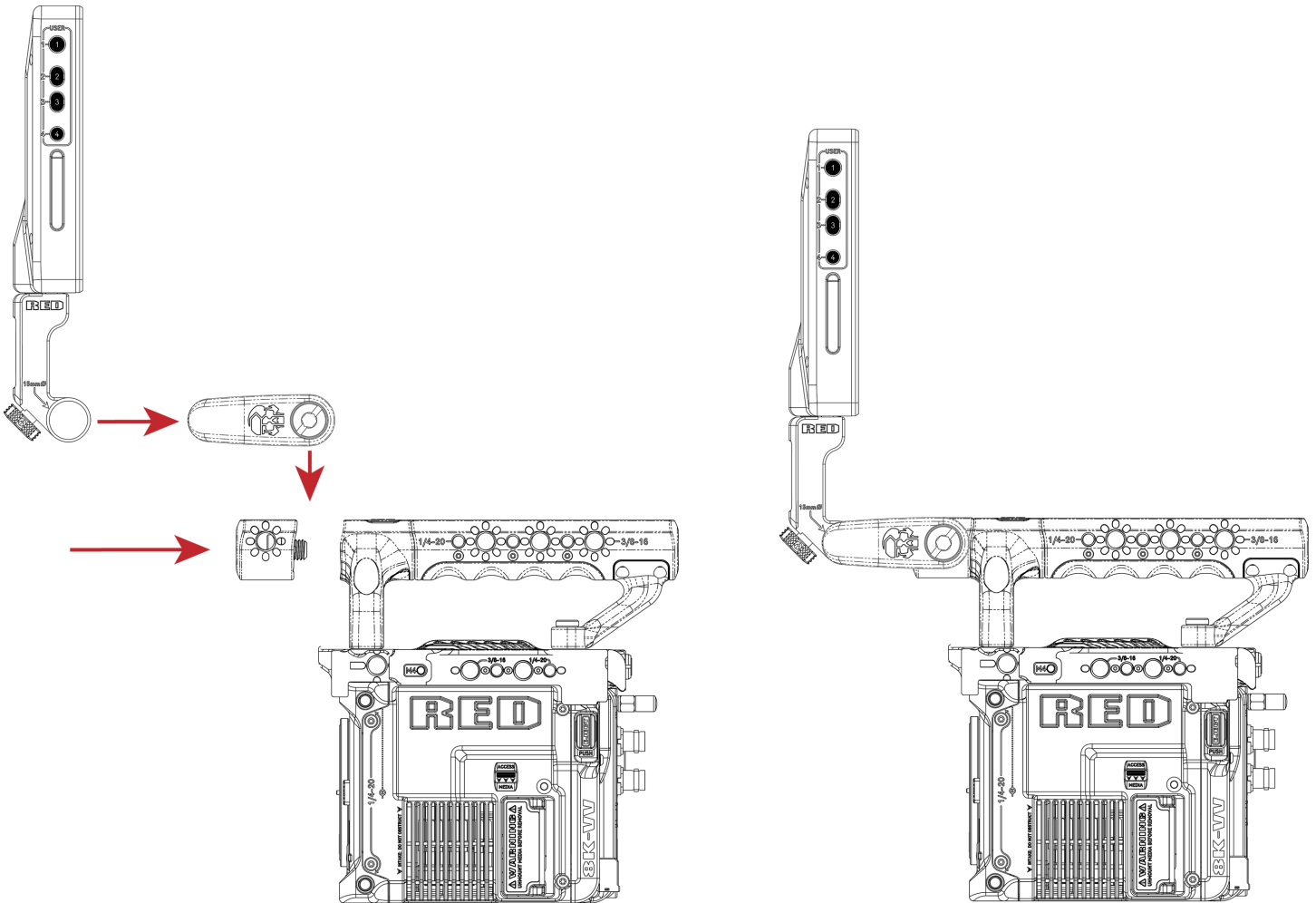



## V-RAPTOR™ WING GRIP

The V-RAPTOR Wing Grip offers comfort and utility for carrying or shooting with your V-RAPTOR 8K S35.



Featuring an ergonomic machined grip with tactical 1/4"-20, 3/8"-16, and M4 mounting points. It is lightweight and offers a seamless low-profile hand-held option.

## OUTRIGGER HANDLE



The Outrigger Handle offers a low profile, 360° adjustable ergonomic pistol grip and integrated Record Start/Stop button. Mounted to the Top Handle Port on your camera, the Outrigger Handle provides comfort, stability, and additional 1/4-20 mounting points for your peripheral camera components. The built-in Record button puts Start/Stop functionality right at your fingertips. You are always ready to capture the perfect shot.

The Outrigger Handle is ideal for shooters who use one hand on the handle for grip and record button access, and the other for lens adjustments or support.

## RED® PRODUCTION GRIPS



The RED® Production Grips provide adjustable and comfortable support and mobility for your V-RAPTOR. With dual ergonomic grips that attach directly to V-RAPTOR Side Ribs (included in the Production Pack) or other rosette mounting points.

**NOTE:** The RED® Production grips are not compatible with DSMC®, DSMC2® or KOMODO®. They are compatible with RED RANGER® or other cinema camera systems featuring standard rosettes.

## V-RAPTOR™ SIDE RIBS



The two V-RAPTOR Side Ribs (included in the V-RAPTOR Production Pack) provide additional side mounting points. The V-RAPTOR Tactical Top Plate and V-RAPTOR™ Quick Release Platform Pack are required before you can mount the V-RAPTOR Side Ribs to the camera.

Each rib provides:

- 3 x 3/8-16 mounting points
- 1 x ARRI rosette mounting point
- 1 x 1/4-20 pass-through to the camera body
- 1 x 1/4-20 mounting point

### DIMENSIONS FOR EACH RIB

|                      |  |
|----------------------|--|
| Height:              | 133 mm   |
| Width:               | 51.5 mm  |
| Depth:               | 42.6 mm  |
| Weight total         | 168.65 Grams   |
| Weight of tray       | 72.67 Grams  |
| Material             | 7075 Aluminum  |
| Mounting to V-RAPTOR | 2 x M4 captive mounting screw on V-Raptor Tactical Top Plate and Quick Release Platform Arca plate                                 |
| Side Rib mounting    | 3 x 3/8-16 mounting points, 1 x ARRI rosette mounting points, 1 x 1/4-20 pass-through to camera body and 1 x 1/4-20 mounting point |

## V-RAPTOR™ EXPANDER BLADE



The V-RAPTOR™ Expander Blade adds options for video and communication connections including Genlock (BNC), Timecode (5-Pin), RED CTRL (4-Pin), and R/S (Run/Stop) 3-Pin.

### NOTE:

- The 3-Pin Fischer R/S port does not provide power, it is for trigger control only.
- The V-RAPTOR camera plate is RRS Dovetail Standard (38 mm).

To attach the Expander Blade to the camera, the following are required (included with purchase of V-RAPTOR™ Expander Blade):

- V-RAPTOR™ Expander Blade
- V-RAPTOR™ Arca Plate (also included in the V-RAPTOR™ Quick Release Platform Pack)
- Anti-Tip Plate (optional)

1. Attach the Arca plate to the bottom of the camera. This plate provides two secure mounting points for the to Expander Blade.

**NOTE:** Without this plate, the Expander Blade cannot be secured to the body, likely resulting in damage to the camera's 9-Pin EXT port and to the Expander Blade's 9-Pin connector.

2. Line up the Expander Blade's 9-Pin connector with the camera's 9-Pin EXT connector and gently slide the Expander Blade towards the camera until the connector is fully seated.
3. Partially screw the front Expander Blade M4 screw to the Arca Plate. Line the rear Expander Blade M4 screw up with the correctly and fully tighten this screw. Return to the front M4 screw to fully tighten.

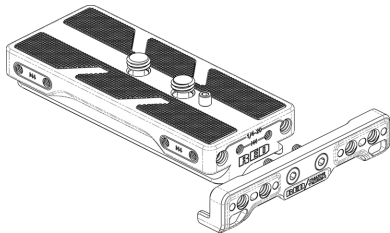

Optionally, you can attach the Anti-Tip Plate to the front of the Arca Plate to prevent the camera from tipping over when resting the camera with the Arca Plate on a hard flat level surface.

To attach the Anti-Tip Plate, ensure the correct orientation of the Anti-Tip Plate & then align the M4 screws with the M4 mounting holes on the front of the Arca Plate (this plate can only be attached at the front of the camera). Tighten down the M4 screws until tight.

For issues or troubleshooting, contact [support@cs.inc](mailto:support@cs.inc).

## DSMC3™ RED® 5-PIN TO SINGLE 3.5 MM ADAPTER



The DSMC3™ RED® 5-Pin to Single 3.5 mm Adapter is a 11.3" (28.9 cm) cable designed to break out the 5-Pin Audio port to a single 3.5 mm TRS input allowing for 3.5 mm audio devices to be connected.

### NOTES:

Length measured from end to end including connectors.

For replacement or additional components, such as screws, contact [support@cs.inc](mailto:support@cs.inc).

COMPATIBILITY: The DSMC3™ RED 5-Pin to Single 3.5 mm Adapter is not compatible with DSMC®, DSMC2®, RED RANGER® or KOMODO® camera systems.

## DSMC3™ RED® 5-PIN TO DUAL XLR ADAPTER



The DSMC3™ RED® 5-Pin to Dual XLR Adapter is a compact solution for breaking out the 5-Pin Audio port to dual 3-Pin XLR ports. This adapter provides two industry standard XLR ports providing 48-volt phantom power, and mic and line input that is easily mounted to your V-RAPTOR™.

The Dual XLR adapter's modular design provides several mounting options for the V-RAPTOR™.

The Dual XLR adapter includes the following:

- Dual XLR adapter
- L-shaped mounting bracket with 2 x 3/16 screws and 4 x Anti-Rotate pins
- A replacement 1/4-20 mounting screw
- 18" Right angle-to-straight 5-Pin cable

To attach the L-shaped mounting bracket:

1. Determine the mounting position on or off of the camera. You may need to re-position or remove the anti-rotate pins on the bracket depending on the orientation and position you want to mount the bracket. You can also mount the bracket to the camera by using the replacement 1/4-20 screw.
2. Screw one of the 3/16 screws in the Dual XLR adapter ensuring the anti-rotate pins line up with the desired position of the Dual XLR adapter. Then attach the other side of the bracket to the position of your choice, confirming that the anti-rotate pins align with holes on the camera.

**NOTE:** Make sure that you only pull on the knurled sleeve of the 90° angle connector on the 18" Right angle-to-straight 5-Pin cable when removing it from the Dual XLR adapter.

## RED® RF TO PL ADAPTER PACK



The RED® RF to PL Adapter Pack provides a robust PL mount solution for the RED V-RAPTOR. Supporting Cooke /i lens communication and record triggering, the RF to PL Adapter expands the functionality of the camera's native RF lens mount for professional applications. Constructed of a titanium core, the shimmable RF to PL Adapter is resistant to environmental temperature changes, providing consistent and precise back focus.

The RED RF to PL Adapter Pack includes V-RAPTOR Adapter Support Brackets to provide additional rigidity and a native-like mount experience.

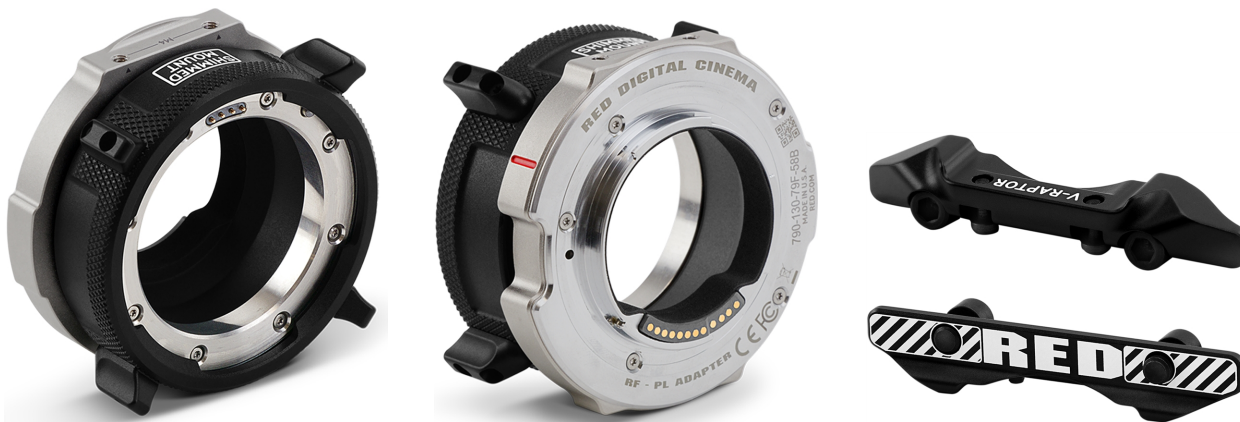

**NOTE:** Note: the RED RF to PL adapter is not compatible with Electronic Filters. The RED RF to PL Adapter with Electronic ND Filter is coming soon.

## V-RAPTOR™ QUICK RELEASE PLATFORM PACK



The V-RAPTOR™ Quick Release Platform Pack provides a compact lightweight shooting configuration for V-RAPTOR users. The system features an Arca Swiss-style camera plate and secure safety lock system, which gets the camera to the correct optical height for 15 mm LWS accessories such as, matte boxes, lens supports, and wireless follow focus systems.

The Arca Plate is useful for securely attaching other V-RAPTOR accessories, such as the Expander Blade, V-Lock or Gold Mount Battery Adapters, Side Rails, Anti-Tip Plate, and Production Plates.

RED designed this elegant solution for V-RAPTOR in collaboration with Dominick Aiello and Creative Solutions.

### NOTES:

- The V-RAPTOR camera plate is a standard RRS dovetail (38 mm).
- For issues or troubleshooting, contact [support@cs.inc](mailto:support@cs.inc)

COMPATIBILITY: The V-RAPTOR Quick Release Platform Pack is not compatible with DSMC®, DSMC2®, RED RANGER®, or KOMODO® camera systems.

Included in the V-RAPTOR Quick Release Platform pack:

- Base plate (15 mm LWS)
- Arca Swiss-style plate



- Bridge plate dovetail



- Anti-Tip Plate (optional)



- Dovetail plate



- 15 mm rods



The base plate has two lever locks and two safety release buttons for securing and releasing the camera Arca plate, and for releasing the dovetail and bridge plate dovetail from the bottom of the base plate.

To release and secure the camera plate to the baseplate the locking lever and release button are located on the top half of the baseplate opposite each other.

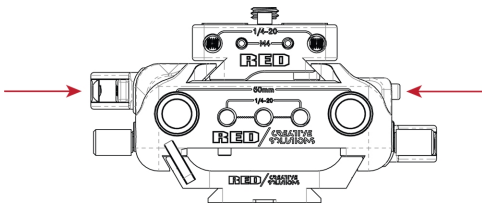

The release and secure the dovetail plates to the bottom of the baseplate the locking lever and release button are located on the bottom half of the baseplate opposite each other.

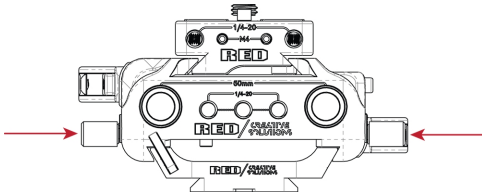

To attach the Camera's Arca Plate, release the top safety lever and slide the camera onto the base plate (this can be done front-to-back or back-to-front). You will hear a click as the security pin engages.

When the plate is in the correct position for your configuration, lock down the top lever ensuring that the lever safety latch engages.

To attach a dovetail plate to the bottom of the Base Plate, release the bottom safety lever & slide the dovetail into the baseplate (this can be done front-to-back or back-to-front). You will hear a click as the security pin engages.

When the plate is in the correct position for your configuration, lock down the left side lever ensuring that the lever safety lock engages.

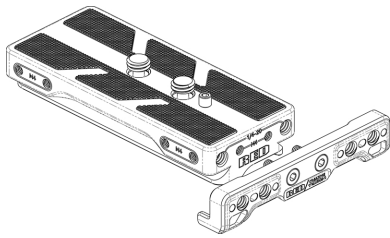

Optionally, you can attach the Anti-Tip Plate to the front of the Arca Plate to prevent the camera from tipping over when resting the camera with the Arca Plate on a hard flat level surface.

To attach the Anti-Tip Plate, ensure the correct orientation of the Anti-Tip Plate & then align the M4 screws with the M4 mounting holes on the front of the Arca Plate (this plate can only be attached at the front of the camera). Tighten down the M4 screws until tight.



## V-RAPTOR™ TACTICAL TOP PLATE AND BATTERY ADAPTER (V-LOCK OR GOLD MOUNT)



The V-RAPTOR™ Tactical Top Plate provides a way to securely mount a larger battery to the back of the camera and mount/ power accessories from the Top Plate. The Top Plate includes two 2-Pin Aux power outputs, assistant side LED light, multiple 3/8-16 & 1/4-20 mounting threads and pogo connection system to interface with the battery adapter.

The Front Cheese Plate provides additional 3/8-16 & 1/4-20 mounting threads. This plate is required for attaching the **V-RAPTOR™ Top Handle and Extensions** when the V-RAPTOR™ Tactical Top Plate is installed.

The V-Lock and Gold Mount battery adapters include a P-tap/D-tap and an E-Fuse safety system and pogo connection system to interface with the Top Plate. These adapters allow the camera to accept full-size V-Lock and Gold Mount batteries.

You can use the V-RAPTOR™ Tactical Top Plate with the **DSMC3™ RED® Touch 7.0" LCD**, **V-RAPTOR™ Top Handle and Extensions**, **Outrigger Handle**, and included Front Cheese Plate.

**NOTE:** The SMBUS Pass-through feature is only available on the V-Lock Battery Adapter.

**NOTE:** The V-RAPTOR Tactical Top Plate w/ Battery Adapter is not compatible with DSMC®, DSMC2®, RED RANGER® or KOMODO® camera systems.

For issues or troubleshooting, contact [support@cs.inc](mailto:support@cs.inc).

# V-RAPTOR™ 8K S35 OPERATION GUIDE

The V-RAPTOR™ Tactical Top Plate and Battery Adapter bundles include:

- Tactical Top Plate



- Front Cheese Plate



- Battery Adapter (V-Lock or Gold Mount)



- Battery Support Bracket



To attach the Top Plate:

1. Align the four screws with corresponding 1/4-20 holes behind the POGO connection point on the top of the camera and tighten down each screw following a cross shape pattern to ensure even distribution of pressure on the plate.
2. Next you can choose to attach the Front Cheese Plate, DSMC3™ RED® Touch 7.0" LCD or Outrigger Handle in-front of the Top Plate.



3. Next to attach the Battery Adapter slide the adapter onto the rear V-Lock plate on the camera body and secure both top screws to the Top Plate to ensure a rigid connection.

**NOTE:** You may need to slightly loosen the Top Plate screws to get the Battery Adapter screw to align with the top plate.

# V-RAPTOR™ 8K S35 OPERATION GUIDE

You can attach the Battery Support Bracket to the bottom of the Battery Adapter and the rear of the Arca Plate (included with Expander Blade & Quick Release Platform Pack) for additional support.

